

# Katalog Proizvoda

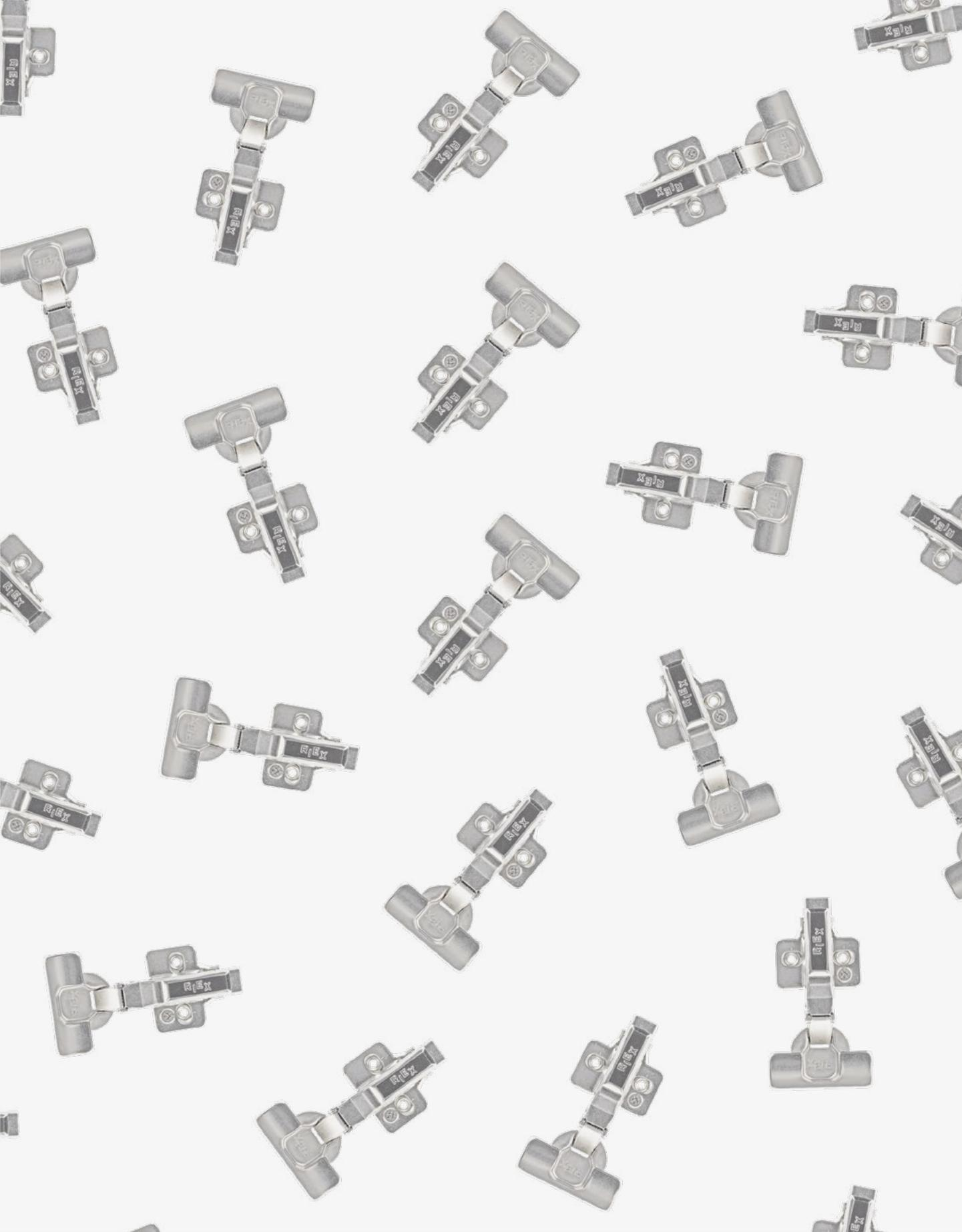

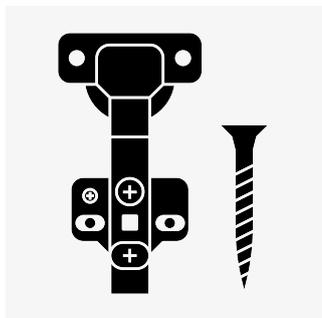



## Okov za namještaj

---



## Rubne trake za namještaj

---



## Ljepila

---

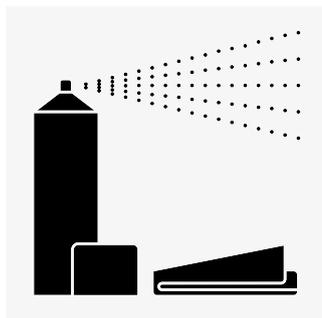

## Sredstva za čišćenje

# O Kompaniji

Hranipex je vodeći europski proizvođač i dobavljač proizvoda i stručni savjetnik za industriju namještaja. Tvrtka čije je sjedište u Češkoj, osnovana je 1993.g, i danas je aktivna u više od 60 zemalja širom svijeta. Njezin širok portfelj proizvoda uključuje okove za namještaj, rubne trake, ljepila, sredstva za čišćenje i druge proizvode za proizvodnju namještaja.

Hranipex je svjestan svoje društvene odgovornosti i pridržava se najviših etičkih principa i principa za održivi razvoj. Obraća pozornost na ulaganja u istraživanje i razvoj, sigurnost i kvalitetu te promiče nove tehnologije koje dovode do uštede energije i smanjenja emisija štetnih plinova. To pojačava i time pridonosimo čuvanju i zaštiti okoliša.

Misija tvrtke temeljena je na čvrstim vrijednostima koje su je pratile kroz njezinu povijest. Briga o zaposlenicima, kupcima, poslovnim partnerima i dobavljačima stvara dugoročne odnose i uspješan timski rad. Sastavni dio aktivnosti u tvrtki Hranipex je opsežna humanitarna djelatnost te podrška kulturnim i sportskim aktivnostima.

Sa strašću za kontinuiranim razvojem i inovacijama te visokom dodanom vrijednošću proizvoda i usluga, Hranipex Grupa postavlja nove standarde, jača svoju tržišnu poziciju i postaje izbor broj jedan ne samo za svoje kupce.

Za više informacija, posjetite  
[www.hranipex.com](http://www.hranipex.com)

Filip Winkelhofer  
Predsjednik odbora

# Proizvodne kategorije

## ● Okovi za namještaj

	Vodilice ladica	01
	Spojnice i Push-to-Open mehanizmi	02
	Mehanizmi za otvaranje	03
	Ručkice, kvake, profili i vješalice	04
	Noge za namještaj, vodilice i kotačići	05
	Noge i vodilice za stolove	06
	Brave, cilindri i magneti	07
	Uredska oprema	08
	Kuhinjska oprema	09
	Kuhinski sustavi za pohranu	10
	Okovi za garderobu	11
	Okovi za klizna vrata	12
	Svjetla i električna oprema	13
	Sastavljanje okova	14
	Priključci i mehanizmi za krevete	15

## ● Rubne trake za namještaj

	ABS, Melamin, Furnir i Ostali	16
---	-------------------------------	----

## ● Ljepila & sredstva za čišćenje

	Ljepila	17
	Sredstva za čišćenje	18

# Vodilice ladica

Za proizvodnju namještaja nudimo široku paletu rješenja sa kompletima ladica. Među popularnim rješenjima su kompleti ladica s dvostrukom stranicom, koji nude jednostavnu ugradnju, odgovarajuću primjenu u svim interijerima i prilagodivost na sve visine i dubine ladice. Odličan izbor u ovom rasponu su RiexTrack kompleti ladica. Moderan i čist uski bočni dizajn uparen s visokom kvalitetom i izdržljivošću vodilice. Nudi se u širokom rasponu dimenzija, atraktivnih boja kao i širokog spektra dodatne opreme, ne samo za kuhinje.





● <b>RiexTrack Ladice s dvostrukom stijenkom</b>	<b>1.3</b>
RiexTrack Ladice	1.4
RiexTrack Pregrade i povišene bočne stijenke	1.9
RiexTrack Unutarnja ladica	1.11
RiexTrack Unutarnja podjela po panelima	1.13
RiexTrack Unutarnja podjela po pregradama	1.15
RiexTrack Pribor za ladice	1.17
RiexTrack Posude za pribor za jelo	1.18
● <b>Riex NX40 Ladice s dvostrukom stijenkom</b>	<b>1.21</b>
Riex NX40 Ladice	1.22
Riex NX40 Podignute bočne stranice	1.29
Riex NX40 Unutarnja ladica	1.30
Riex NX40 Unutarnja podjela po Panelima	1.32
Riex NX40 Unutarnja podjela po pregradama	1.34
Riex NX40 Pribor za ladice	1.36
● <b>Skrivene vodilice</b>	<b>1.37</b>
Skrivene vodilice – potpuno izvlačenje	1.38
Skrivene vodilice – jednostruki Nastavak	1.41
● <b>Kuglične vodilice</b>	<b>1.45</b>
Kuglične vodilice – Soft-Close	1.46
Kuglične vodilice – Push-to-Open	1.48
Kuglične vodilice – bez Soft-Close	1.49
● <b>Metalne vodilice</b>	<b>1.55</b>
● <b>Klizne vodilice</b>	<b>1.61</b>

# RiexTrack ladice s dvostrukom stijenkom

- Ladice s dvostrukim stijenkom
- Nosivost 40 kg
- Trajnost 60 000 ciklusa
- Dostupno u 4 visine bočne stranice visine i duljine od 270 do 650 mm
- Glatki i tihi rad sa mekim zatvaranjem zahvaljujući sinkronizaciji
- Atraktivne boje
- Široka paleta dodatne opreme
- Debljina donje ploče 16 mm
- Nosači integrirani u bočne stranice
- Podešavanje prednje ploče u vodoravnom i okomitom smjeru plus nagib ladice:
  - Podešavanje gore / dolje:  $\pm 2$  mm
  - Podešavanje lijevo / desno:  $\pm 1$  mm
  - Podešavanje nagiba:  $\pm 2$  mm



# RiexTrack Ladice

## ⊕ RiexTrack Visina 89 mm

Duljina NL [mm]	Bijela	Tamno siva	Crna
270	F000213	F000179	x
300	F000214	F000180	x
350	F000215	F000181	x
400	F000216	F000182	F000250
450	F000217	F000183	F000251
500	F000218	F000184	F000252
550	F000219	F000185	x
600	F000220	F000186	x
650	F000221	F000187	x

### Sadržaj paketa:

- Par bočnih stranica
- Par poklopaca
- Sinhronizacija vodilica
- Vijci za prednje nosače
- Par prednjih nosača



○ Bijela



● Tamno siva



● Crna

### ⊕ Dimenzije donje i stražnje ploče

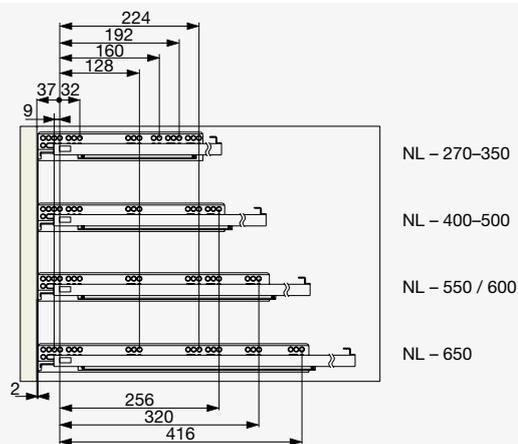
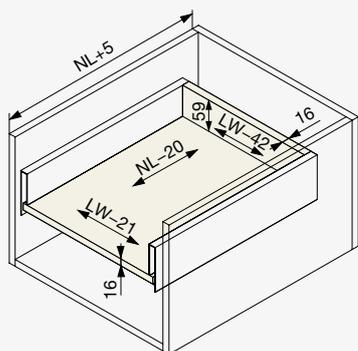

### ⊕ Legenda

- H = 89  
NL – nazivna duljina vodilice  
NL+5 – unutarnja dubina ormara  
NL-20 – dubina donje ploče  
LW – unutarnja širina ormara  
LW-21 – širina donje ploče  
LW-29 – širina držača prednje ploče  
LW-42 – širina stražnje ploče

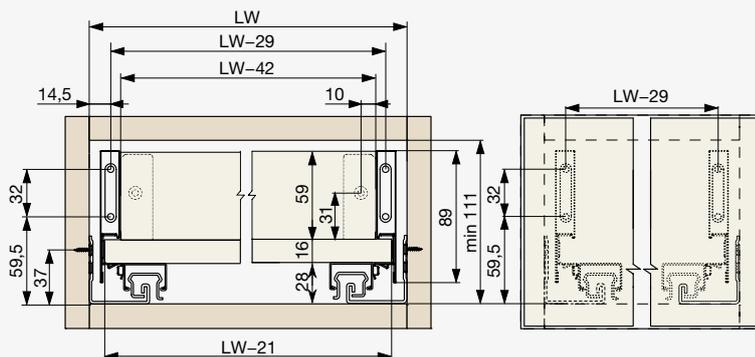

## ⊕ RiexTrack Visina 121 mm

Duljina NL [mm]	Bijela	Tamno siva	Crna
270	F000222	F000188	x
300	F000223	F000189	x
350	F000224	F000190	x
400	F000225	F000191	F000259
450	F000226	F000192	F000260
500	F000227	F000193	F000261
550	F000228	F000194	x
600	F000229	F000195	x
650	F000230	F000196	x

### Sadržaj paketa:

- Par bočnih stranica
- Sinhronizacija vodilica
- Par prednjih nosača
- Par poklopaca
- Vijci za prednje nosače



○ Bijela



● Tamno siva



● Crna

### ⊕ Dimenzije donje i stražnje ploče

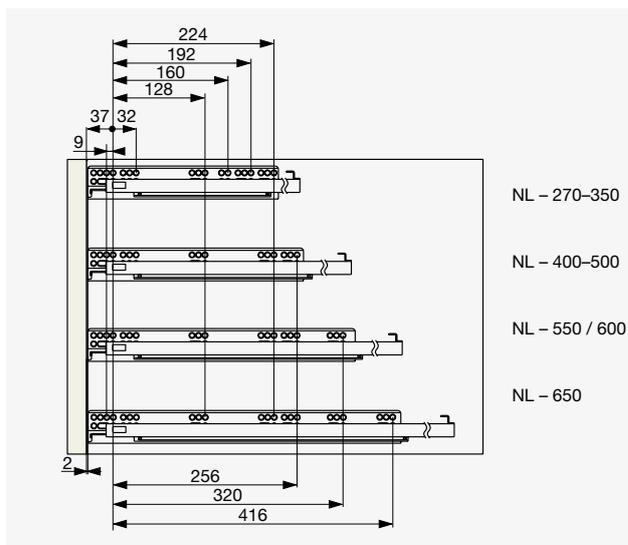
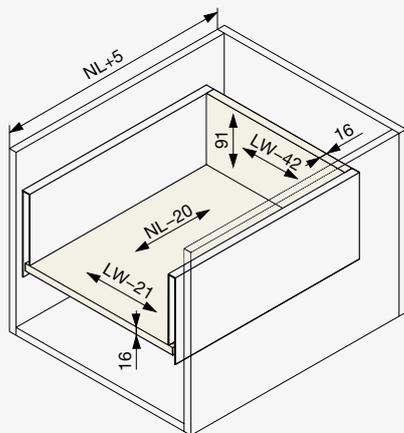

### ⊕ Legenda

- H = 121  
 NL – nazivna duljina vodilice  
 NL+5 – unutarnja dubina ormara  
 NL-20 – dubina donje ploče  
 LW – unutarnja širina ormara  
 LW-21 – širina donje ploče  
 LW-29 – širina držača prednje ploče  
 LW-42 – širina stražnje ploče

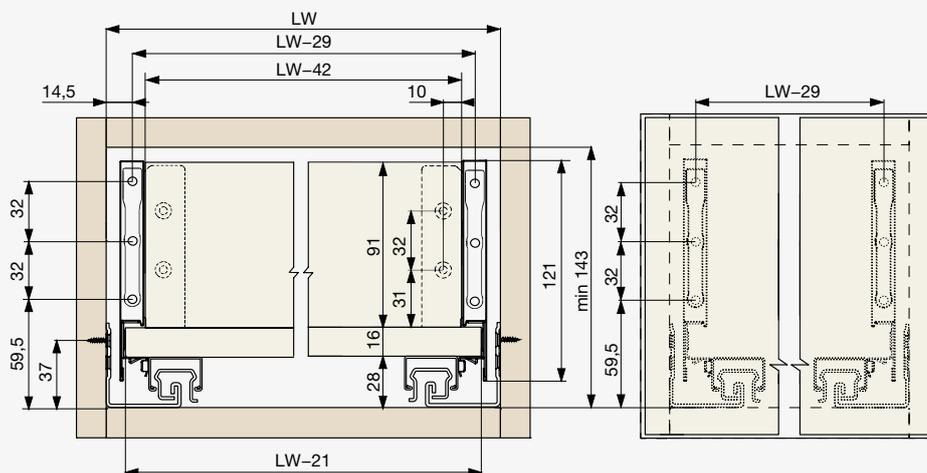

## ⊕ RiexTrack Visina 185 mm

Duljina NL [mm]	Bijela	Tamno siva	Crna
300	F000231	F000197	x
350	F000232	F000198	x
400	F000233	F000199	F000267
450	F000234	F000200	F000268
500	F000235	F000201	F000269
550	F000236	F000202	x
600	F000237	F000203	x
650	F000238	F000204	x

### Sadržaj paketa:

- Par bočnih stranica
- Uparivanje slajdova
- Par prednjih nosača
- Par poklopaca
- Vijci za prednje nosače



○ Bijela



● Tamno siva



● Crna

### ⊕ Dimenzije donje i stražnje ploče

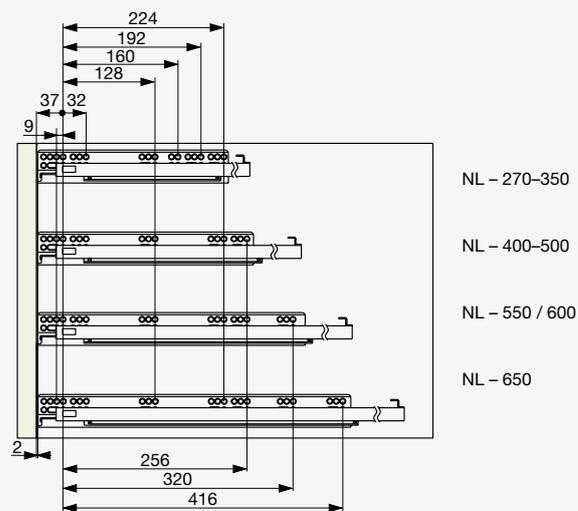
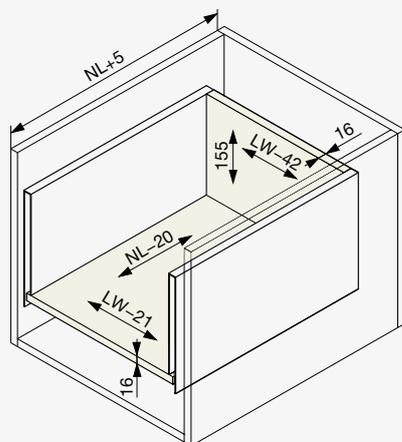

### ⊕ Legenda

- H = 185
- NL - nazivna duljina vodilice
  - NL+5 - unutarnja dubina ormara
  - NL-20 - dubina donje ploče
  - LW - unutarnja širina ormara
  - LW-21 - širina donje ploče
  - LW-29 - širina držača prednje ploče
  - LW-42 - širina stražnje ploče

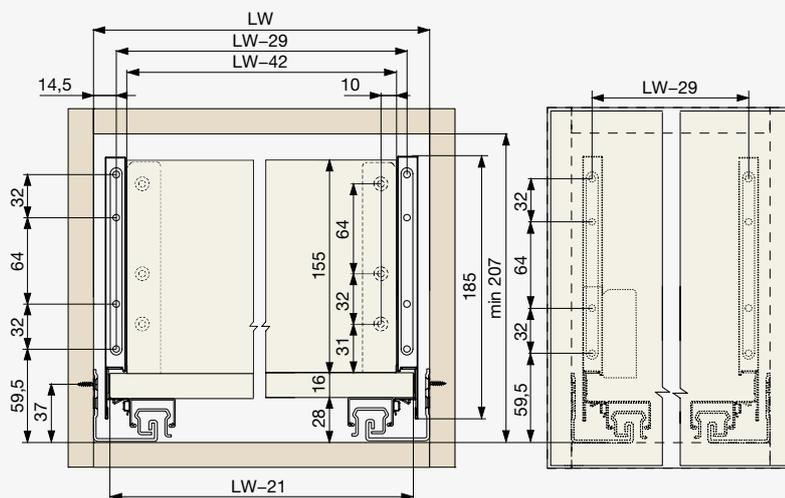

## ⊕ RiexTrack Visina 249 mm

Duljina NL [mm]	Bijela	Tamno siva	Crna
450	F000242	F000208	F000276
500	F000243	F000209	F000277
550	F000244	F000210	x
600	F000245	F000211	x

### Sadržaj paketa:

- Par bočnih zidova
- Uparivanje slajdova
- Par prednjih nosača
- Par poklopaca
- Vijci za prednje nosače



○ Bijela



● Tamno siva



● Crna

### ⊕ Dimenzije donje i stražnje ploče

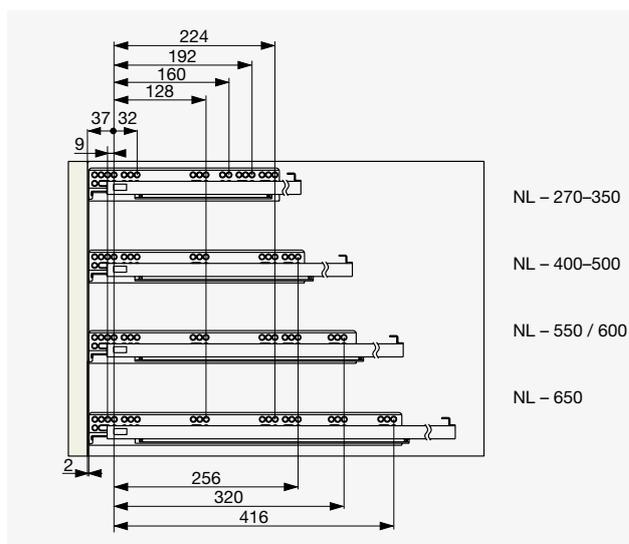
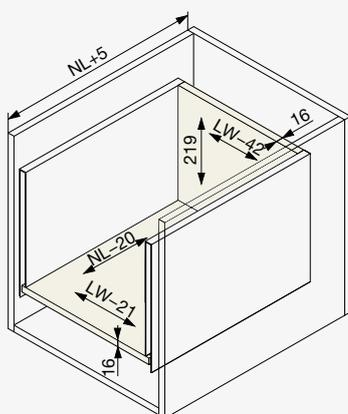

### ⊕ Legenda

- H = 249
- NL – nazivna duljina vodilice
  - NL+5 – unutarnja dubina ormara
  - NL-20 – dubina donje ploče
  - LW – unutarnja širina ormara
  - LW-21 – širina donje ploče
  - LW-29 – širina držača prednje ploče
  - LW-42 – širina stražnje ploče

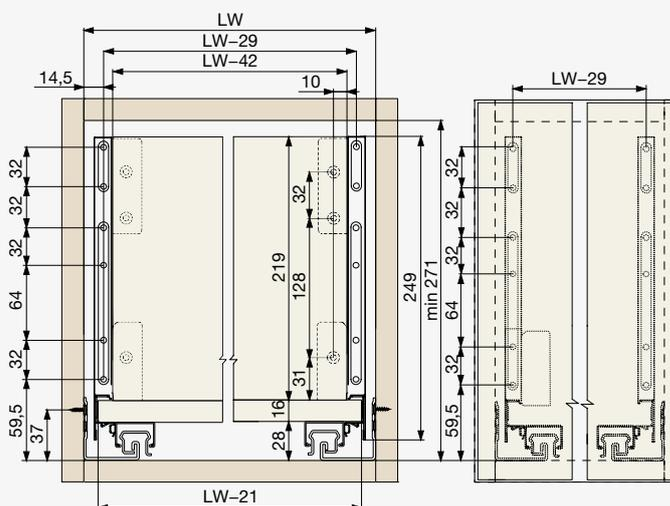

- 01
- 02
- 03
- 04
- 05
- 06
- 07
- 08
- 09
- 10
- 11
- 12
- 13
- 14
- 15
- 16
- 17
- 18



# RiexTrack Pregrade i povišene bočne stijenke

## ⊕ RiexTrack Četvrtaste pregrade

Duljina NL [mm]	Bijela	Tamno siva	Crna
300	F000657	F000648	×
350	F000658	F000649	×
400	F000659	F000650	F000665
450	F000660	F000651	F000666
500	F000661	F000652	F000667
550	F000662	F000653	×
600	F000663	F000654	×
650	F000664	F000655	×

Sadrži par četvrtastih relinga i stražnje nosače.



○ Bijela

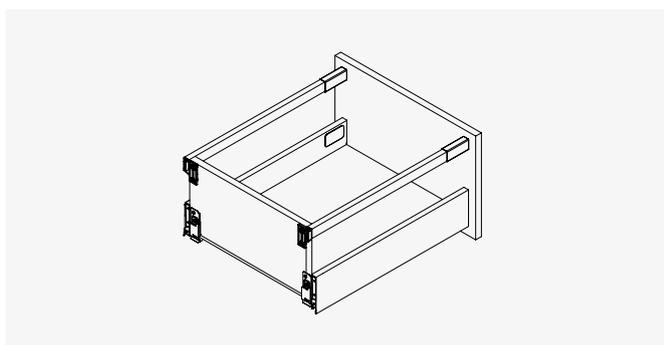

● Tamno siva



● Crna

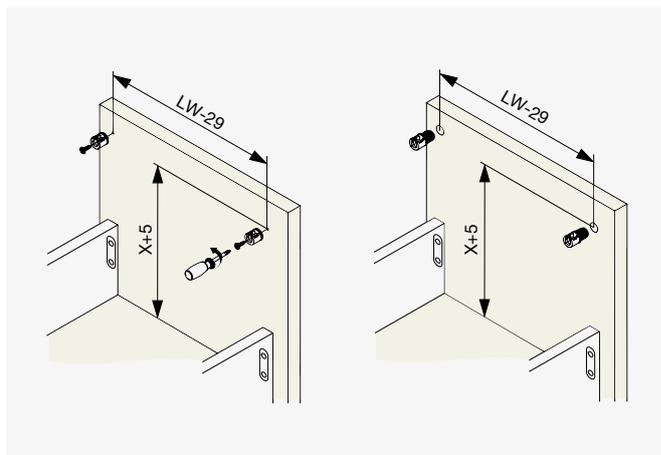
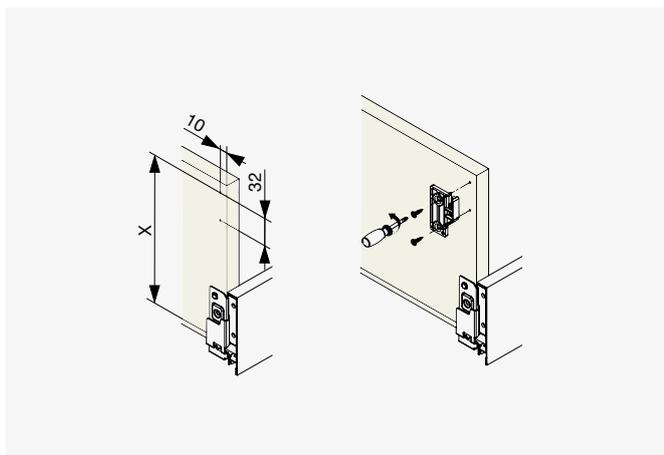

### ⊕ Legenda

LW – unutarnja širina ormara

LW-29 – širina držača prednje ploče

X – udaljenost nosača stražnje pregrade od donje ploče

X+5 – udaljenost nosača prednje pregrade od donje ploče



## ⊕ RiexTrack Povišene bočne stijenke s perforacijom

Duljina NL [mm]	Bijela	Tamno siva	Crna
300	F000600	F000609	x
350	F000601	F000610	x
400	F000602	F000611	x
450	F000603	F000612	x
500	F000604	F000613	x
550	F000605	F000614	x
600	F000606	F000615	x
650	F000607	F000616	x

Uzdignute bočne stijenke moraju se koristiti s četvrtastim relinzima. Perforacija u podignutim bočnim stijenama služi za postavljanje unutarnjih pregrada – str. 1.13–1.14.



○ Bijela

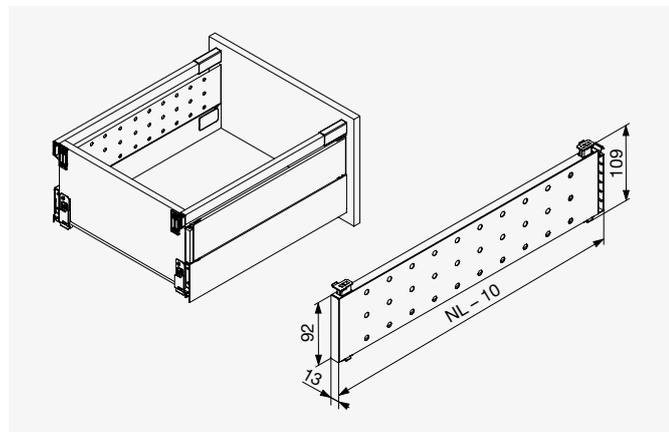

● Tamno siva

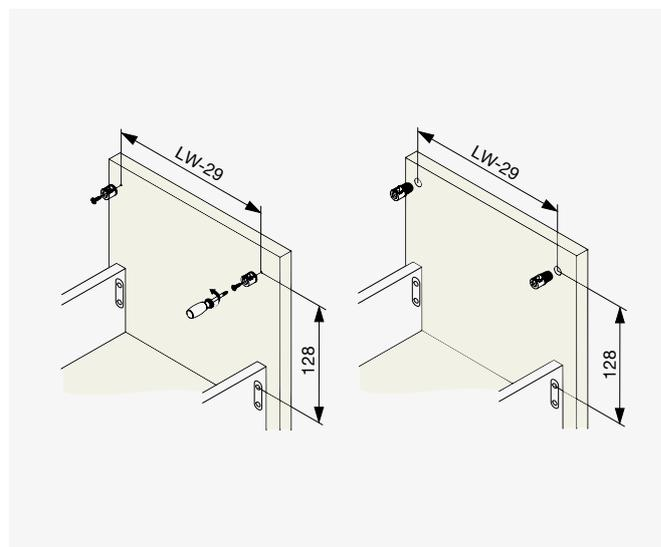
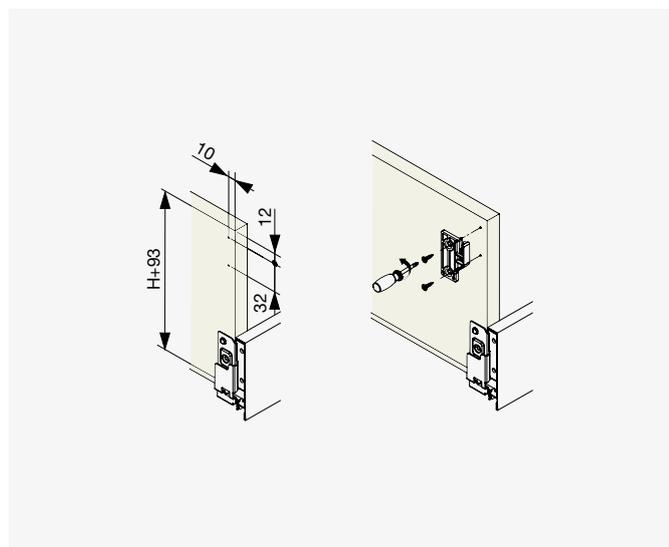

### ⊕ Legenda

LW – unutarnja širina ormara  
 LW-29 – širina držača prednje ploče  
 H – visina ladice  
 H+93 – visina stražnje ploče

# RiexTrack

## Unutarnja ladica

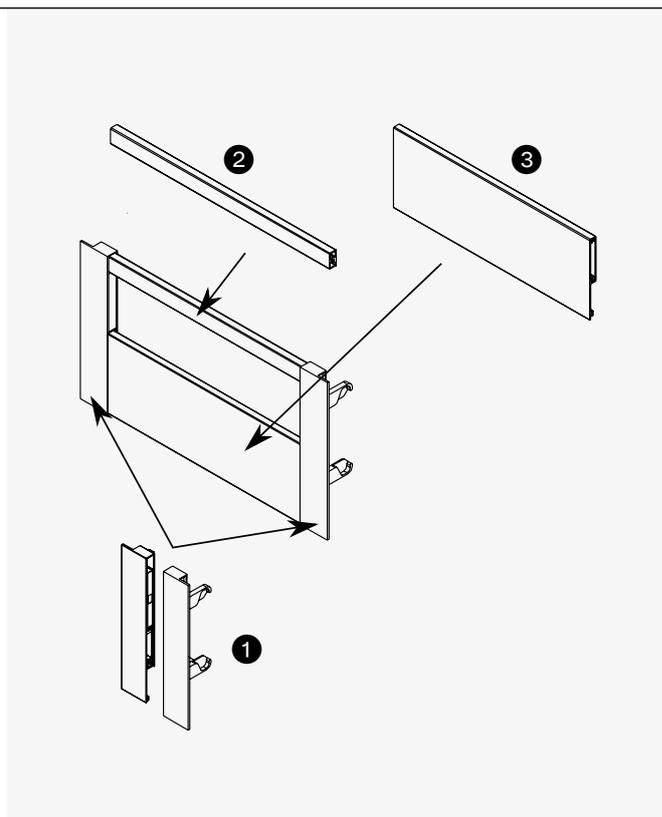

### 1 RiexTrack Držac prednje ploče

Visina [mm]	Bijela	Tamno siva	Crna
89	F000627	F000623	F000631
121	F000628	F000624	F000632
185	F000629	F000625	F000633



○ Bijela



● Tamno siva



● Crna

## ② RiexTrack Prednja četvrtasta pregrada

- Prednja pregrada namijenjena rezanju
- Duljina pregrade je LW-55  
[LW = unutarnja širina ormara]

Duljina [mm]	Bijela	Tamno siva	Crna
800	F000643	F000641	F000645
1100	F000644	F000642	F000646



## ③ RiexTrack Prednja ploča

- Prednja ploča namijenjena rezanju
- Duljina ploče je LW-87  
[LW = unutarnja širina ormara]

Duljina [mm]	Bijela	Tamno siva	Crna
800	F000637	F000635	F000639
1100	F000638	F000636	F000640



## ④ RiexTrack Donja potpora

- Donja potpora za šire ladice
- Preporučuje se od širine ladice 600 mm

Pozicija	Kod
Potpoda [unutarnja ladica]	F000691



# RiexTrack Unutarnja podjela po panelima

- Kompatibilno samo s perforiranim bočnim stijenkama – str. 1.10

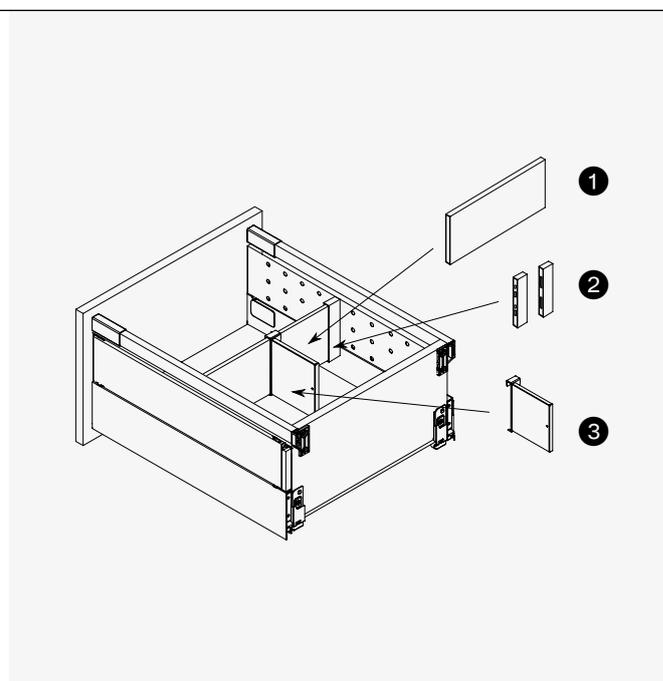
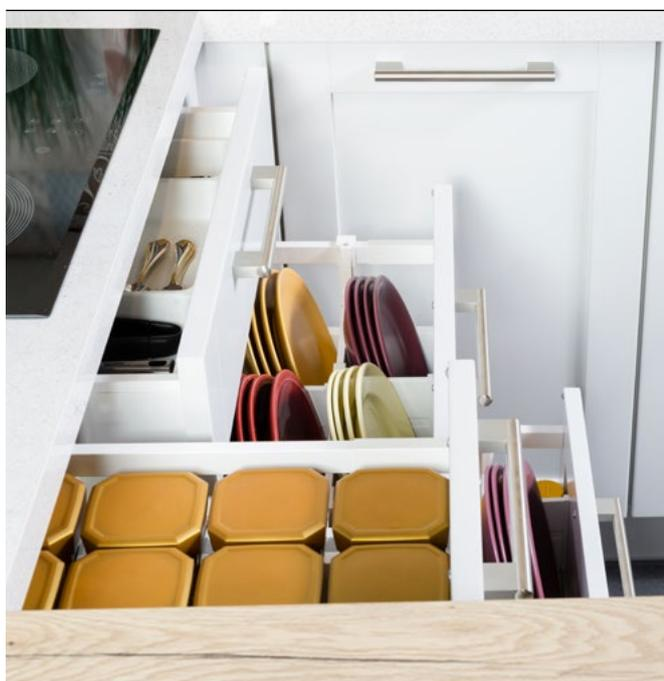

## 1 RiexTrack Ploča za razdvajanje u unakrsnom razdvajanju

- Pregradna ploča namijenjena rezanju
- Duljina ploče je LW-64 [LW = unutarnja širina ormara]

Duljina [mm]	Bijela	Tamno siva	Crna
1100	F000619	F000620	x



○ Bijela

● Tamno siva

## ② RiexTrack Završni Dijelovi Panela

Bijela	Tamno siva	Crna
F000621	F000622	x

Sadrži par završnih dijelova.



○ Bijela



● Tamno siva

## ③ RiexTrack Pregradna Ploča

Bijela	Tamno siva	Crna
F000617	F000618	x



○ Bijela



● Tamno siva

# RiexTrack Unutarnja podjela po pregradama

- Kompatibilno s kvadratnim pregradama samo za podizanje ladice

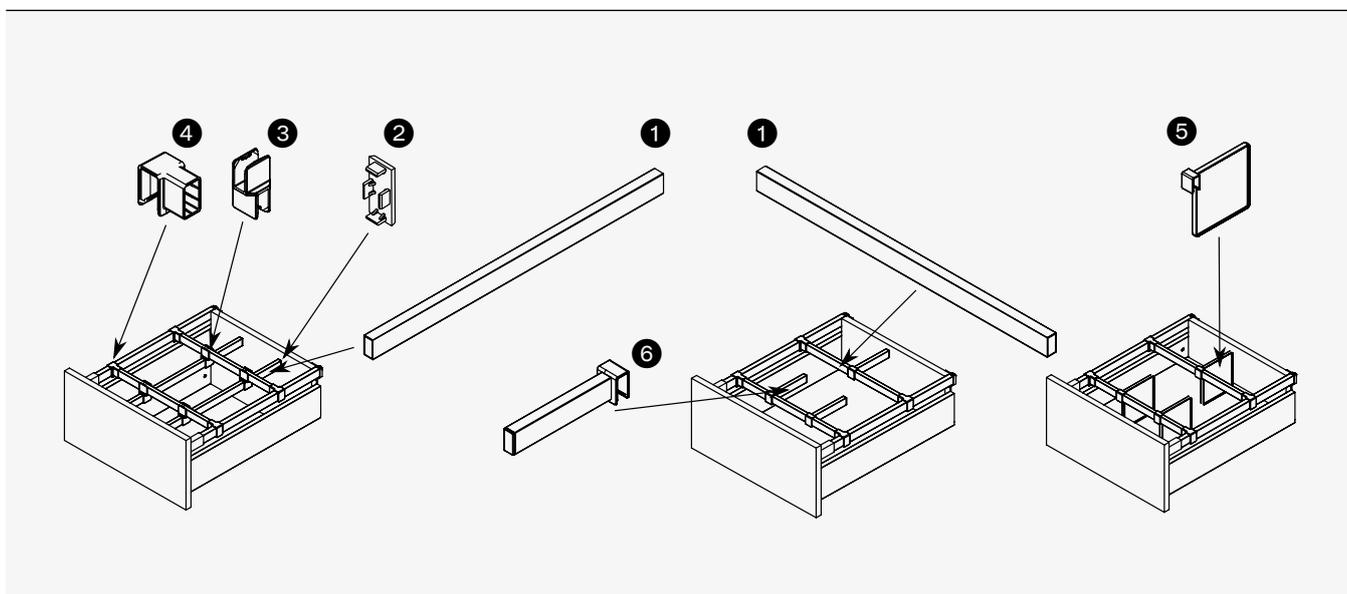

## 1 RiexTrack Pregrada za dijeljenje



○ Bijela

● Tamno siva

- Dijeljenje pregrade namijenjene rezanju
- Duljina pregrade za uzdužnu uporabu je NL-40 [NL = nazivna duljina vodilice]
- Duljina pregrade za unakrsnu uporabu je LW-52 [LW = unutarnja širina ormara]

Duljina [mm]	Bijela	Tamno siva	Crna
800	F000670	F000668	x
1100	F000671	F000669	x

## 2 RiexTrack Poklopac gornje granice pregrade

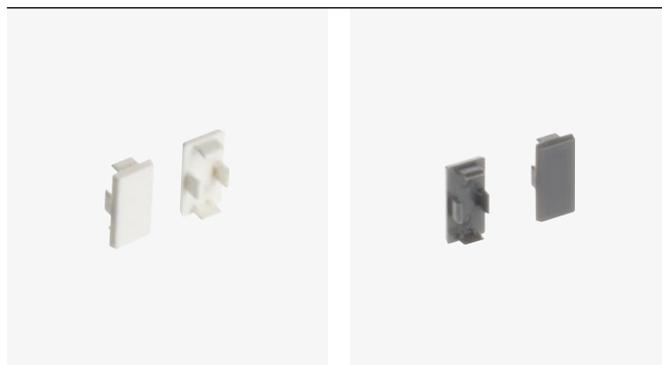

○ Bijela

● Tamno siva

Bijela	Tamno siva	Crna
F000677	F000676	x

Sadrži par završnih poklopaca.

### ③ RiexTrack Unakrsni poveznik



<input type="radio"/> Bijela	<input checked="" type="radio"/> Tamno siva	
Bijela	Tamno siva	Crna
F000675	F000674	x

Pakirano po 1 komad.

### ④ RiexTrack T Dodatak



<input type="radio"/> Bijela	<input checked="" type="radio"/> Tamno siva	
Bijela	Tamno siva	Crna
F000673	F000672	x

Pakirano po 1 komad.

### ⑤ RiexTrack Razdjelna ploča



<input type="radio"/> Bijela	<input checked="" type="radio"/> Tamno siva	
Bijela	Tamno siva	Crna
F000679	F000678	x

### ⑥ RiexTrack Razdjelni profil



<input type="radio"/> Bijela	<input checked="" type="radio"/> Tamno siva	
Bijela	Tamno siva	Crna
F000681	F000680	x

# RiexTrack

## Pribor za ladice

### ⊕ RiexTrack Zaštitna kapa bez logotipa

Bijela	Tamno siva	Crna
F000687	F000686	F000688



○ Bijela

● Tamno siva

● Crna

### ⊕ RiexTrack Donja potpora

- Donja potpora za šire ladice
- Preporučeno od širine ladice 600 mm

Pozicija	Kod
Prednja strana	F000689
Natrag	F000690
Prednja [unutarnja ladica]	F000691



### ⊕ RiexTrack Predložak za montažu prednjih ploča

Visina [mm]	Kod
89	F000682
121	F000683
185	F000684
249	F000685





# RiexTrack

## Posude za pribor za jelo

### ⊕ RiexTrack Set od 3 + 2 odjeljka

- Širina 276 mm
- Posude od nehrđajućeg čelika

Duljina [mm]	Bijela	Tamno siva	Crna
500	F000693	F000696	F000699

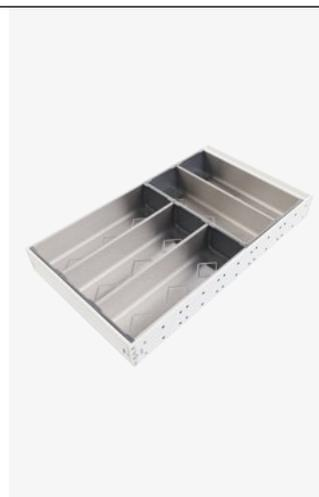

○ Bijela



● Tamno siva



● Crna

### ⊕ RiexTrack Set od 3 + 3 zdjele

- Širina 276 mm
- Posude od nehrđajućeg čelika

Duljina [mm]	Bijela	Tamno siva	Crna
500	F000701	F000704	F000707



○ Bijela



● Tamno siva



● Crna

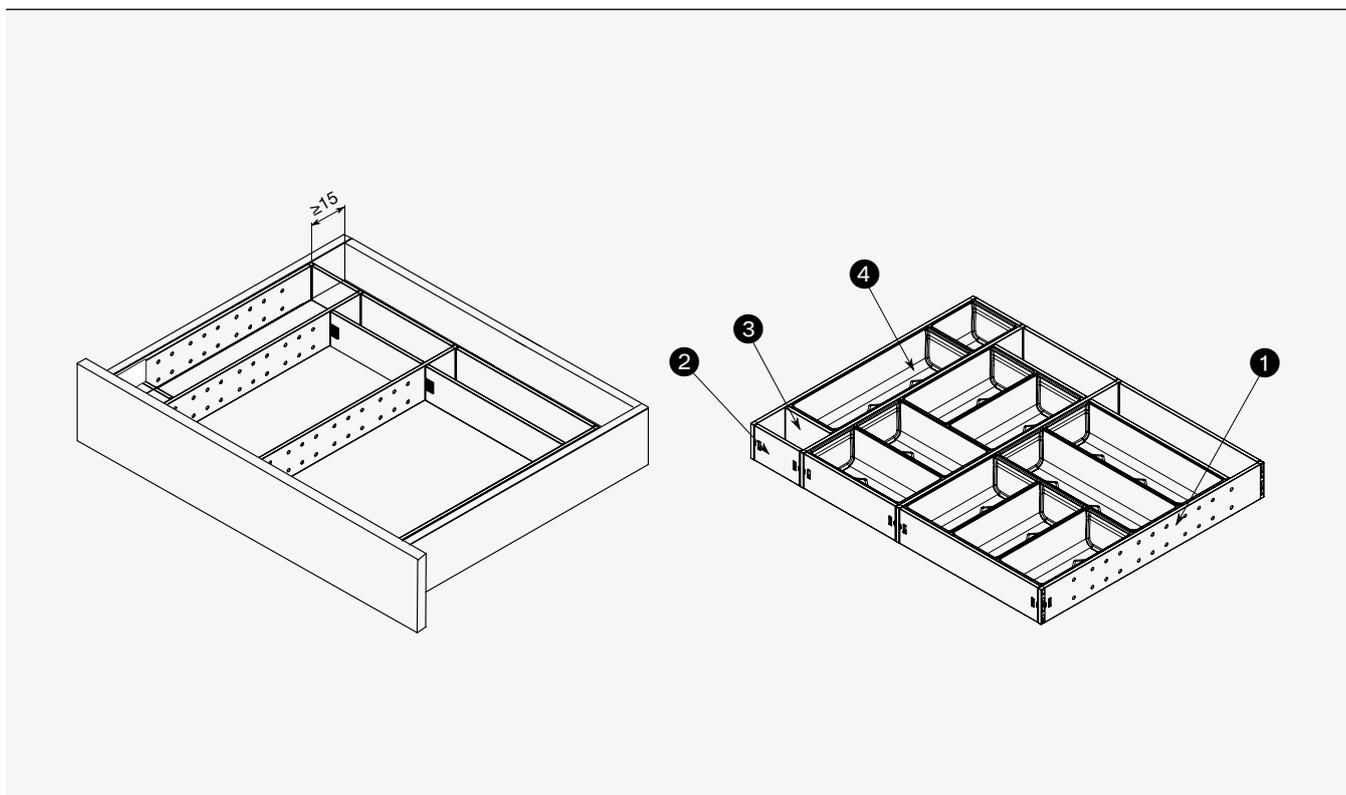

- Komponente za jednostavno sastavljanje vlastite ladice za pribor za jelo

## 1 RiexTrack Bočna ploča



○ Bijela

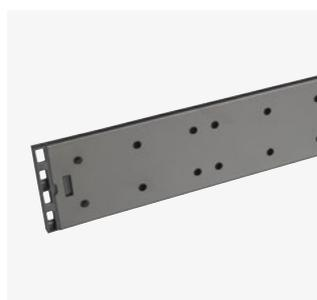

● Tamno siva



● Crna

Duljina [mm]	Bijela	Tamno siva	Crna
500	F000729	F000732	F000735

## ② RiexTrack Prednja i stražnja ploča

Visina [mm]	Bijela	Tamno siva	Crna
88	F000719	F000722	F000725
176	F000720	F000723	F000726
264	F000721	F000724	F000727



○ Bijela



● Tamno siva



● Crna

## ③ RiexTrack Unutarnja pregradna ploča

Visina [mm]	Bijela	Tamno siva	Crna
88	F000736	F000739	F000742
176	F000737	F000740	F000743
264	F000738	F000741	F000744



○ Bijela



● Tamno siva



● Crna

## ④ RiexTrack posuda



Duljina [mm]	Nehrdajući čelik
88	F000716
176	F000717
264	F000718

## ⑤ RiexTrack Protuklizna kopča



Kod

F000745

Koristi se za pričvršćivanje ladice za pribor za jelo u ladici.

# Riex NX40

- Ladice s dvostrukom stijenkom
- Nosivost 35 kg
- Trajnost 60 000 ciklusa
- Dostupan u 3 visine [podignut ogradama]
- Duljine od 300 mm do 550 mm
- Lagan i tih rad s mekim zatvaranjem
- Širok izbor dodatne opreme
- Debljina donje ploče 16 mm
- Podešavanje prednje ploče u vodoravnom i okomitom smjeru:
  - Podešavanje gore / dolje:  $\pm 2$  mm
  - Podešavanje lijevo / desno:  $\pm 1$  mm



# Riex NX40 Ladice

## ⊕ Riex NX40 Visina 86 mm

Duljina NL [mm]	Bijela	Siva
300	F000437	F000443
350	F000438	F000444
400	F000439	F000445
450	F000440	F000446
500	F000441	F000447
550	F000442	F000448

### Sadržaj paketa:

- Par bočnih stranica
- Uparivanje vodilica
- Uparivanje stražnjih nosaca
- Par prednjih nosača
- Par poklopaca
- Vijci za prednje nosače



○ Bijela



● Siva

### ⊕ Dimenzije donje i stražnje ploče

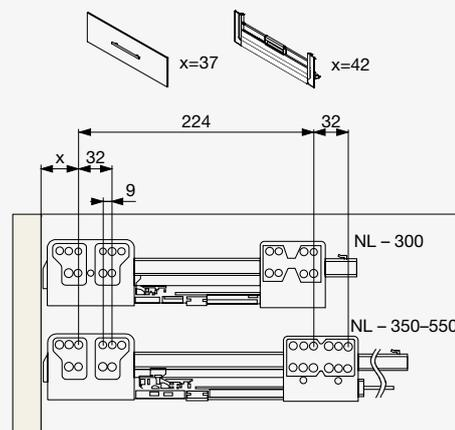
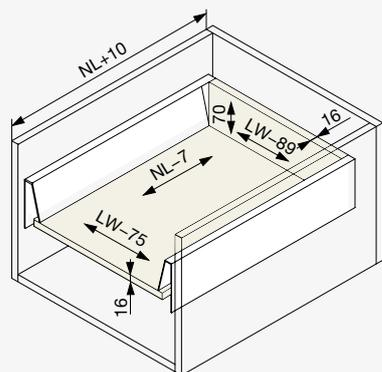

### ⊕ Legenda

- H = 86
- NL - nominalna duljina vodilice
  - NL +10 - unutarnja dubina ormara
  - NL -7 - dubina donje ploče
  - LW - unutarnja širina ormara
  - LW-40 - širina držača prednje ploče
  - LW-75 - širina donje ploče
  - LW-89 - širina stražnje ploče

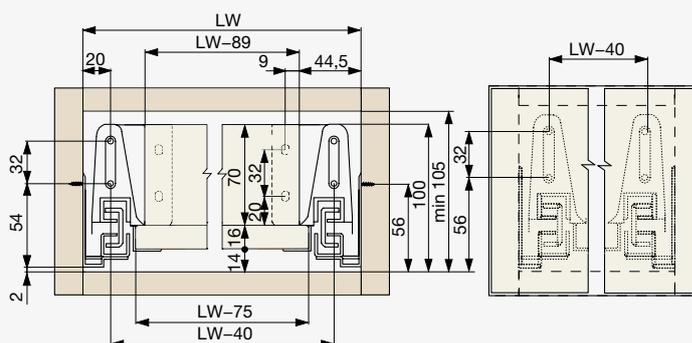

01  
02  
03  
04  
05  
06  
07  
08  
09  
10  
11  
12  
13  
14  
15  
16  
17  
18

## ⊕ Riex NX40 Visina 140 mm, 2 okrugla relinga

- Potrebno posebno naručiti osnovnu ladicu i set relinga

### Bijela

Duljina NL [mm]	Osnovna ladicica 86 mm		Set relinga
300	F000437	+	F000449
350	F000438	+	F000450
400	F000439	+	F000451
450	F000440	+	F000452
500	F000441	+	F000453
550	F000442	+	F000454

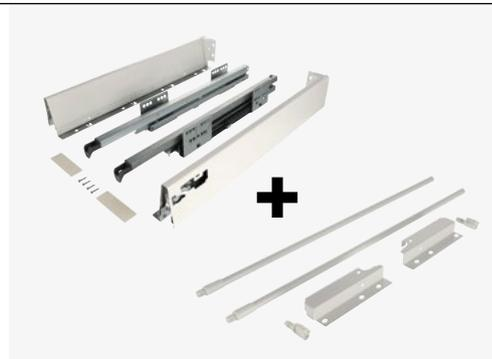

○ Bijela

### Siva

Duljina NL [mm]	Osnovna ladicica 86 mm		Set relinga
300	F000443	+	F000455
350	F000444	+	F000456
400	F000445	+	F000457
450	F000446	+	F000458
500	F000447	+	F000459
550	F000448	+	F000460



● Siva

Set relinga sadrži 2 okrugla relinga i nosače za leđa.

### ⊕ Dimenzije donje i stražnje ploče

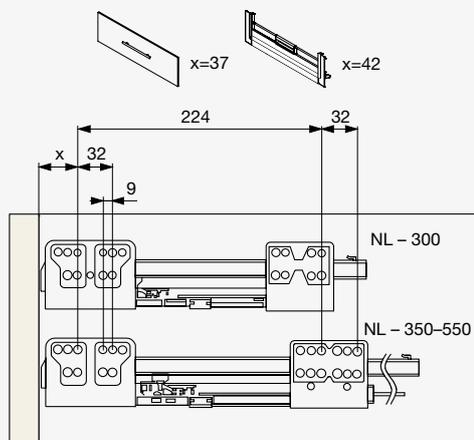
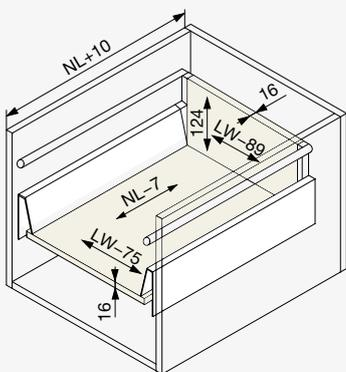

### ⊕ Legenda

- H = 140  
 NL – nominalna duljina vodilice  
 NL+10 – unutarnja dubina ormarića  
 NL-7 – dubina donje ploče  
 LW – unutarnja širina ormarića  
 LW-40 – širina držača  
 prednje ploče i držača pregrade  
 LW-75 – širina donje ploče  
 LW-89 – širina stražnje ploče

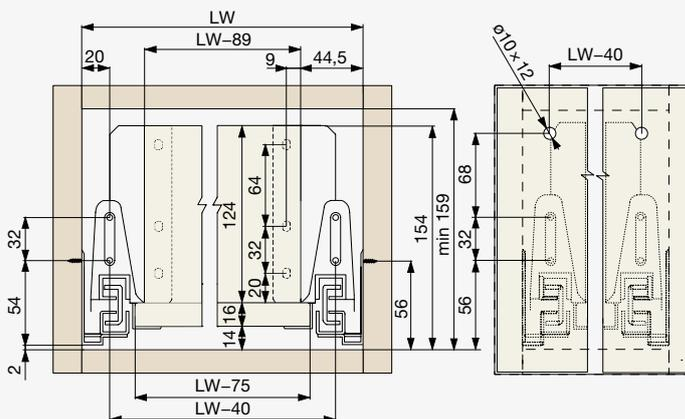

## ⊕ Riex NX40 Visina 140 mm, 2 četvrtasta relinga

- Potrebno posebno naručiti osnovnu ladice i set relinga

Bijela			
Duljina NL [mm]	Osnovna ladica 86 mm		Set relinga
300	F000437	+	F000461
350	F000438	+	F000462
400	F000439	+	F000463
450	F000440	+	F000464
500	F000441	+	F000465
550	F000442	+	F000466

Siva			
Duljina NL [mm]	Osnovna ladica 86 mm		Set relinga
300	F000443	+	F000467
350	F000444	+	F000468
400	F000445	+	F000469
450	F000446	+	F000470
500	F000447	+	F000471
550	F000448	+	F000472

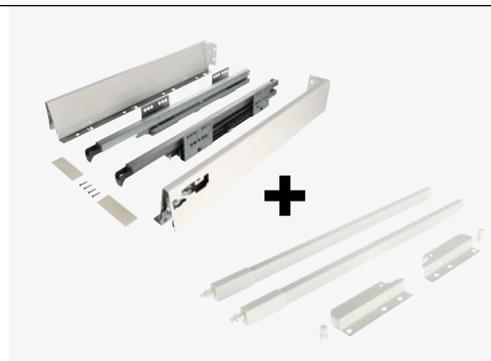

○ Bijela



● Siva

Set relinga sadrži 2 četvrtasta relinga i nosace za leđa.

### ⊕ Dimenzije donje i stražnje ploče

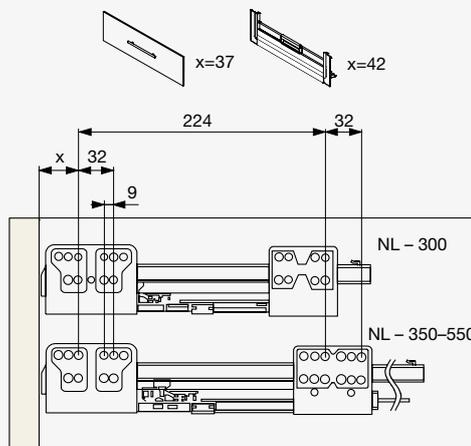
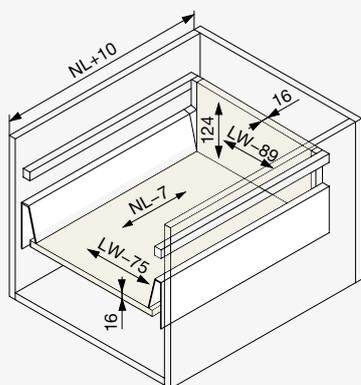

### ⊕ Legenda

H = 140  
 NL – nominalna duljina vodilice  
 NL+10 – unutarnja dubina ormarića  
 NL-7 – dubina donje ploče  
 LW – unutarnja širina ormarića  
 LW-40 – širina držača  
 prednje ploče i držača pregrade  
 LW-75 – širina donje ploče  
 LW-89 – širina stražnje ploče

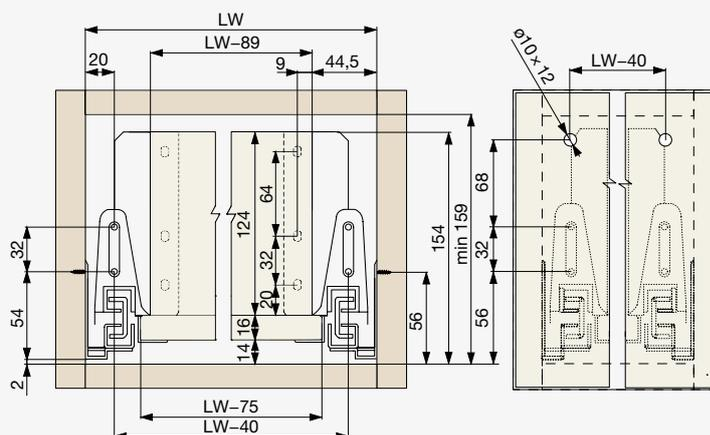

01  
02  
03  
04  
05  
06  
07  
08  
09  
10  
11  
12  
13  
14  
15  
16  
17  
18

## ⊕ Riex NX40 Visina 204 mm, 2 okrugle pregrade

- Potrebno posebno naručiti osnovnu ladicu i set ogradica

### Bijela

Duljina NL [mm]	Osnovna ladicu 86 mm		Set relinga
300	F000437	+	F000473
350	F000438	+	F000474
400	F000439	+	F000475
450	F000440	+	F000476
500	F000441	+	F000477
550	F000442	+	F000478



○ Bijela

### Siva

Duljina NL [mm]	Osnovna ladicu 86 mm		Set relinga
300	F000443	+	F000479
350	F000444	+	F000480
400	F000445	+	F000481
450	F000446	+	F000482
500	F000447	+	F000483
550	F000448	+	F000484



● Siva

Set relinga sadrži 2 okrugla relinga i zadnje prihvate. Produžene stranice na strani 1.29 se mogu koristiti za ovaj set.

### ⊕ Dimenzije donje i stražnje ploče

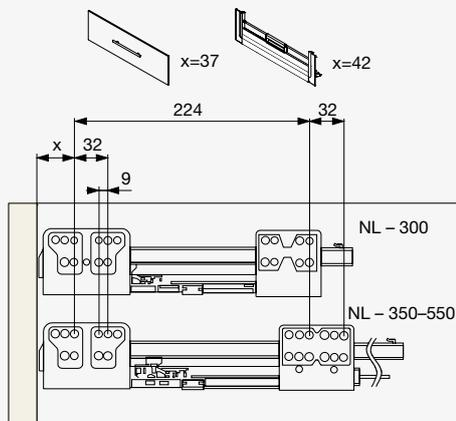
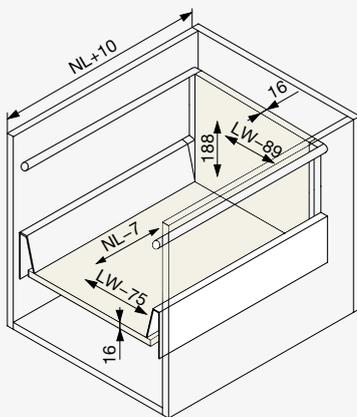

### ⊕ Legenda

- H = 204  
 NL – nominalna duljina vodilice  
 NL+10 – unutarnja dubina ormarića  
 NL-7 – dubina donje ploče  
 LW – unutarnja širina ormarića  
 LW-40 – širina držača  
 prednje ploče i držača pregrade  
 LW-75 – širina donje ploče  
 LW-89 – širina stražnje ploče

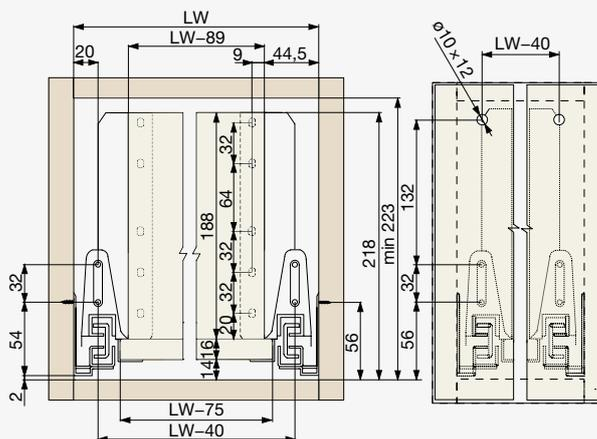



## ⊕ Riex NX40 Visina 204 mm, 2 četvrtaste pregrade

- Potrebno posebno naručiti osnovnu ladicu i set ogradica

Bijela			
Duljina NL [mm]	Osnovna ladicu 86 mm		Set relinga
300	F000437	+	F000485
350	F000438	+	F000486
400	F000439	+	F000487
450	F000440	+	F000488
500	F000441	+	F000489
550	F000442	+	F000490

Siva			
Duljina NL [mm]	Osnovna ladicu 86 mm		Set relinga
300	F000443	+	F000491
350	F000444	+	F000492
400	F000445	+	F000493
450	F000446	+	F000494
500	F000447	+	F000495
550	F000448	+	F000496

Set relinga sadrži 2 četvrtasta relinga i zadnje prihvate.



○ Bijela

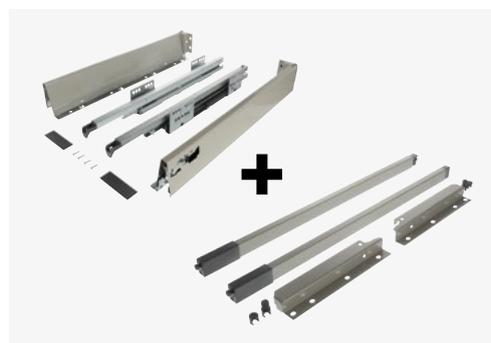

● Siva

### ⊕ Dimenzije donje i stražnje ploče

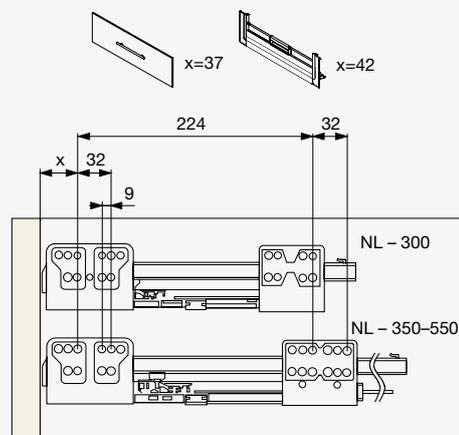
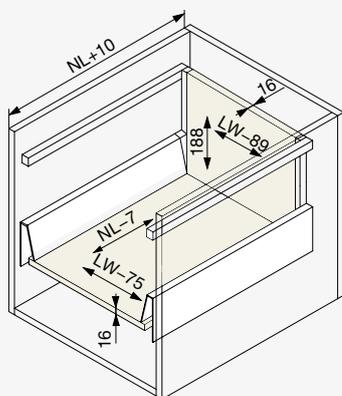

### ⊕ Legenda

- H = 204  
 NL – nominalna duljina vodilice  
 NL+10 – unutarnja dubina ormarića  
 NL-7 – dubina donje ploče  
 LW – unutarnja širina ormarića  
 LW-40 – širina držača  
 prednje ploče i držača pregrade  
 LW-75 – širina donje ploče  
 LW-89 – širina stražnje ploče

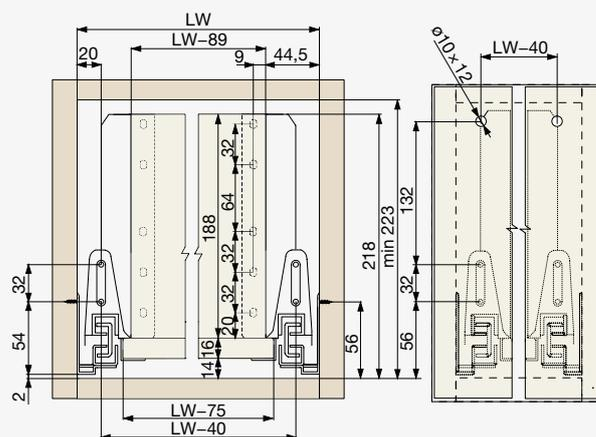

## ⊕ Riex NX40 Visina 204 mm, 4 okrugla relinga

- Potrebno posebno naručiti osnovnu ladicu i set ogradica

### Bijela

Duljina NL [mm]	Osnovna ladicu 86 mm		Set relinga
300	F000437	+	F000497
350	F000438	+	F000498
400	F000439	+	F000499
450	F000440	+	F000500
500	F000441	+	F000501
550	F000442	+	F000502

### Siva

Duljina NL [mm]	Osnovna ladicu 86 mm		Set relinga
300	F000443	+	F000503
350	F000444	+	F000504
400	F000445	+	F000505
450	F000446	+	F000506
500	F000447	+	F000507
550	F000448	+	F000508



○ Bijela



● Siva

Set relinga sadrži 4 okrugla relinga i zadnje prihvate.

### ⊕ Dimenzije donje i stražnje ploče

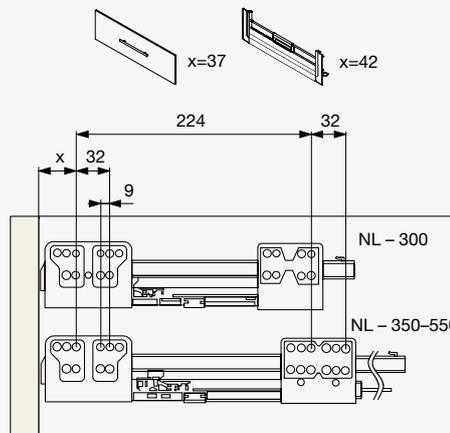
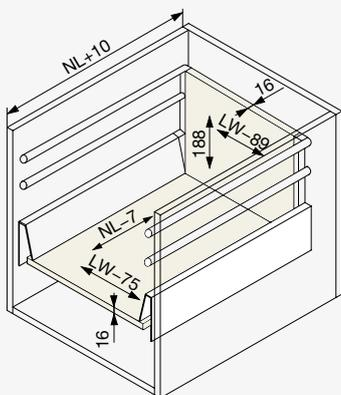

### ⊕ Legenda

- H = 204  
 NL – nazivna duljina vodilice  
 NL +10 – dubina unutarnjeg ormara  
 NL-7 – dubina donje ploče  
 LW – unutarnja širina ormara  
 LW-40 – širina držača  
 prednje ploče i držača relinga  
 LW-75 – širina donje ploče  
 LW-89 – širina stražnje ploče

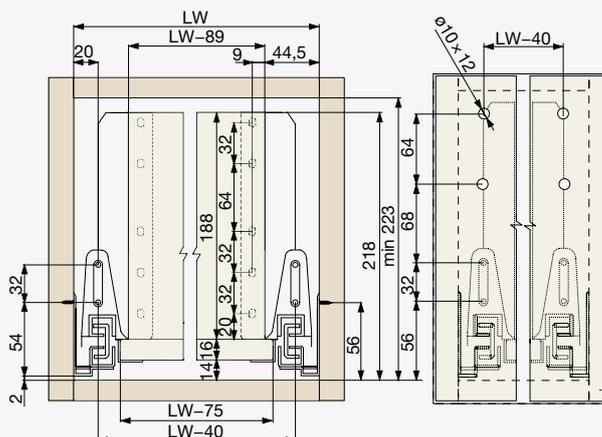

## ⊕ Riex NX40 Visina 204 mm, 4 četvrtasta relinga

- Neophodno naručiti osnovni ladica i set relinga odvojeno

Bijela			
Duljina NL [mm]	Osnovna ladica 86 mm		Set relinga
300	F000437	+	F000509
350	F000438	+	F000510
400	F000439	+	F000511
450	F000440	+	F000512
500	F000441	+	F000513
550	F000442	+	F000514

Sivo			
Duljina NL [mm]	Osnovni, temeljni ladica 86 mm		Set od relinga
300	F000443	+	F000515
350	F000444	+	F000516
400	F000445	+	F000517
450	F000446	+	F000518
500	F000447	+	F000519
550	F000448	+	F000520

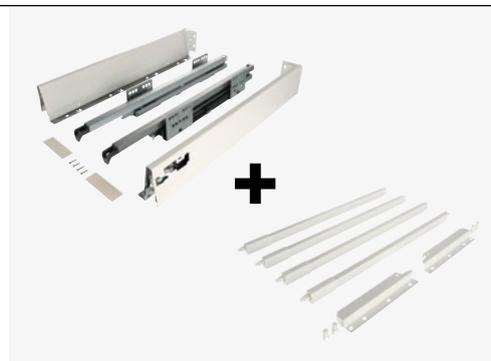

○ Bijelo



● Sivo

Set relinga sadrži 4 četvrtasta relinga i zadnje prihvate.

### ⊕ Donja i stražnja ploča dimenzije

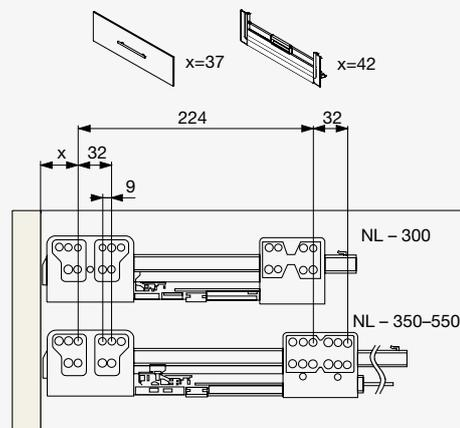
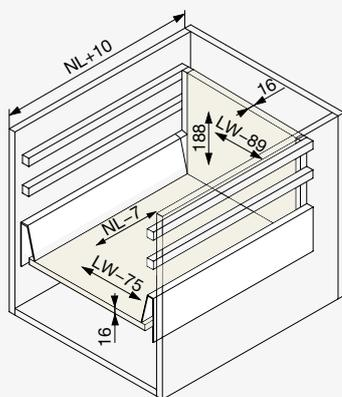

### ⊕ Legenda

H = 204  
 NL – nazivna duljina vodilice  
 NL+10 – unutarnje kabinet dubine  
 NL-7 – dubina donje ploče  
 LW – unutarnja širina ormara  
 LW-40 – širina prednje ploče držači i držač za pregrade  
 LW-75 – širina od dno ploča  
 LW-89 – širina stražnje ploče

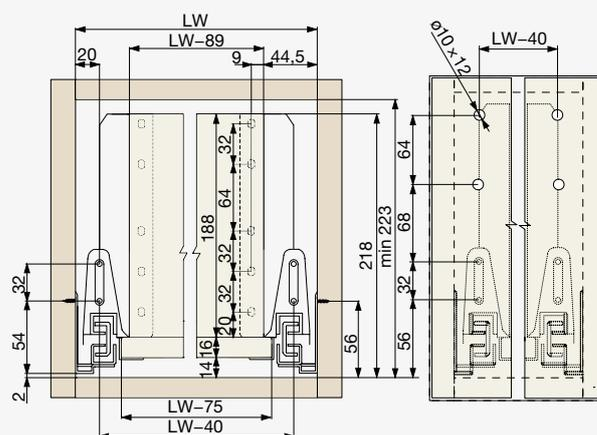

# Riex NX40

## Podignute Bočne stranice

### ⊕ Riex NX40 podignute bočne stijenke

Duljina [mm]	Bijela	Sivo
300	F000399	F000393
350	F000400	F000394
400	F000401	F000395
450	F000402	F000396
500	F000403	F000397
550	F000404	F000398

Sadrži par podignutih bočnih stijenki.  
Podignute bočne stranice mogu se kombinirati s postavom na str. 1.25  
Perforacija u podignutih bočnih stijenka služi za unutarnje  
pozicioniranje razdjelnika – str. 1.32–1.33.

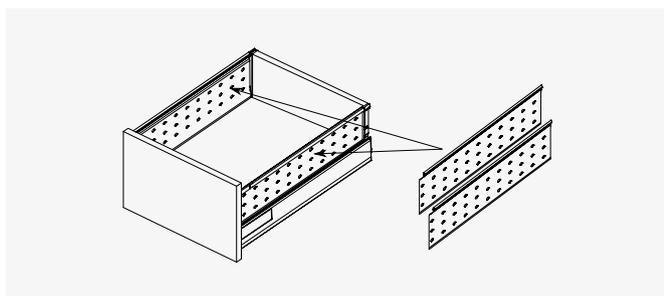

○ Bijelo



● Sivo

# Riex NX40

## Unutarnja ladica

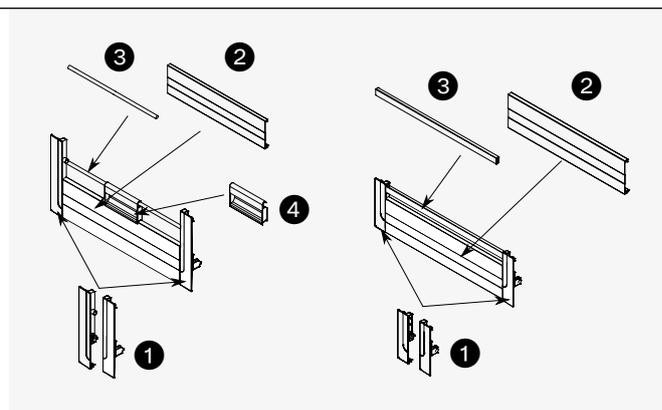

### 1 Držač prednje ploče Riex NX40

Visina [mm]	Br. od uzdužni pregrade	Pregrada oblik	Bijela	Sivo
86	x	x	F000371	F000375
140	2	Okruglo	F000372	F000376
		Kvadrat	F000380	F000384
204	2	Okruglo	F000373	F000377
		Trg	F000381	F000385
	4	Okruglo	F000374	F000378
		Trg	F000382	F000386



○ Bijelo



● Sivo



○ Bijelo



● Sivo

### 2 Prednja ploča Riex NX40

- Prednja ploča namijenjena za rezanje
- Duljina panela je LW-87 [LW = unutarnja širina ormarića]

Duljina [mm]	Bijela	Sivo
1100	F000387	F000388



○ Bijela



● Siva

### ③ Riex NX40 prednja okrugla pregrada

- Prednja pregrada namijenjena za rezanje
- Duljina pregrade je LW-71 [LW = unutarnja širina ormarića]

Duljina [mm]	Bijela	Sivo
1100	F000411	F000412



○ Bijela

● Siva

### ③ Riex NX40 prednja četvrtasta pregrada

- Ispred relinga namijenjena za rezanje
- Duljina pregrade je LW-71 [LW = unutarnja širina ormarića]

Duljina [mm]	Bijela	Siva
1100	F000389	F000390



○ Bijelo

● Sivo

### ④ Riex NX40 ručka za prednju okruglu pregradu

- Dostupno samo za visinu 204 mm

Bijelo	Siva
F000391	F000392



○ Bijelo

● Sivo

# Riex NX40 Unutarnja podjela po panelima

- Kompatibilno samo s perforiranim uzdignutim bočnim stranicama – str. 1.29

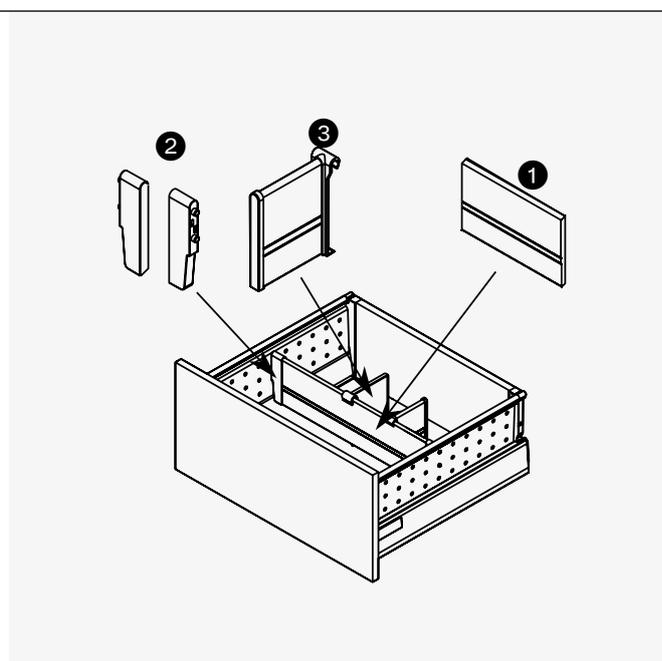

## 1 Riex NX40 poprečna pregradna ploča

- Pregradna ploča namijenjena za rezanje
- Duljina panela je LW-101 [LW = unutarnja širina ormarića]

Duljina [mm]	Bijela	Sivo
1100	F000406	F000405

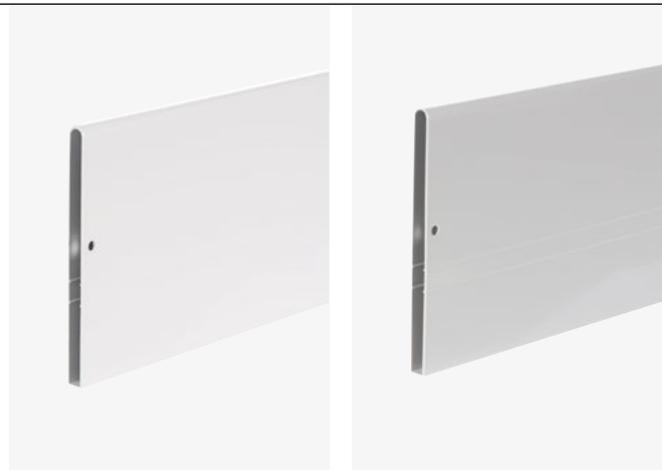

○ Bijela

● Tamno siva

## 2 Završni dijelovi ploče Riex NX40

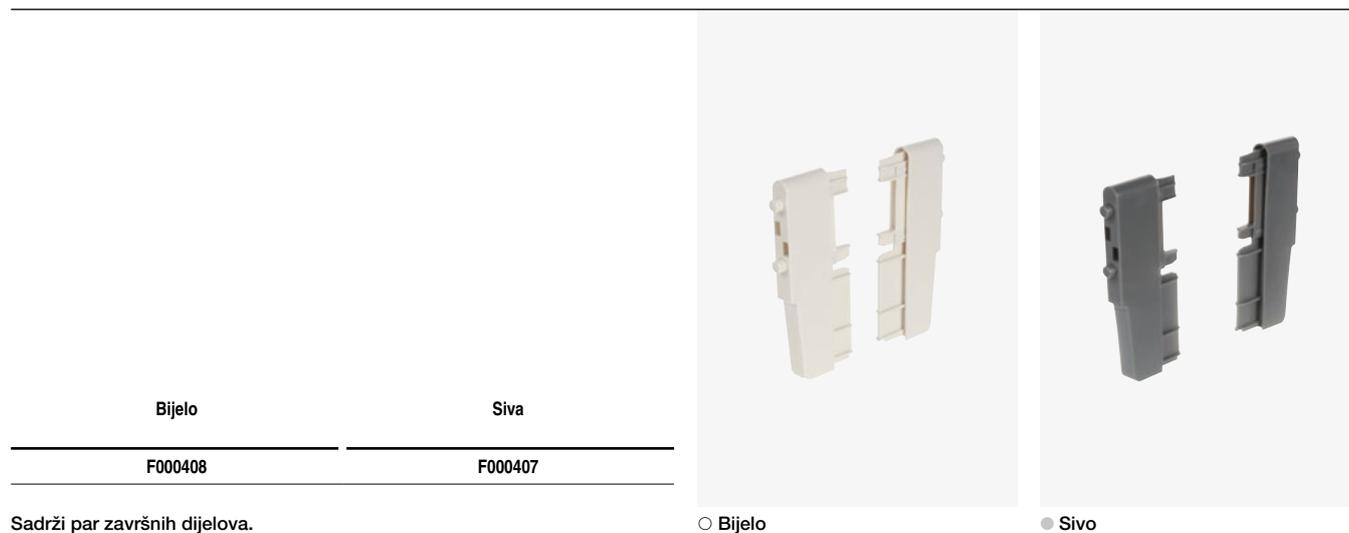

Sadrži par završnih dijelova.

## 3 Riex NX40 pregradna ploča





# Riex NX40 Unutarnje dijeljenje po pregradama

- Kompatibilno samo s okruglim i četvrtastim ogradama za podizanje ladice
- Neophodno kombinirati okruglo s okruglim, četvrtasto s četvrtastim

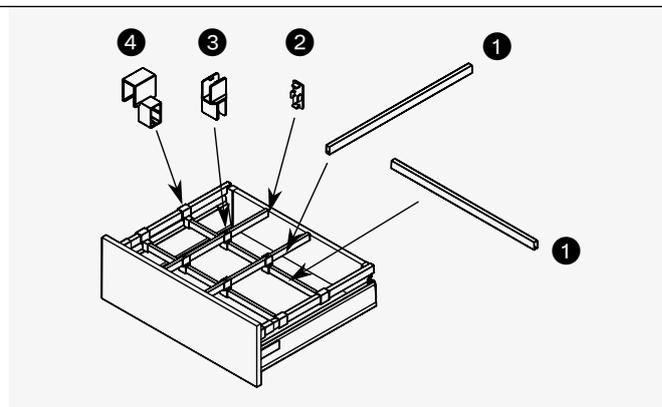
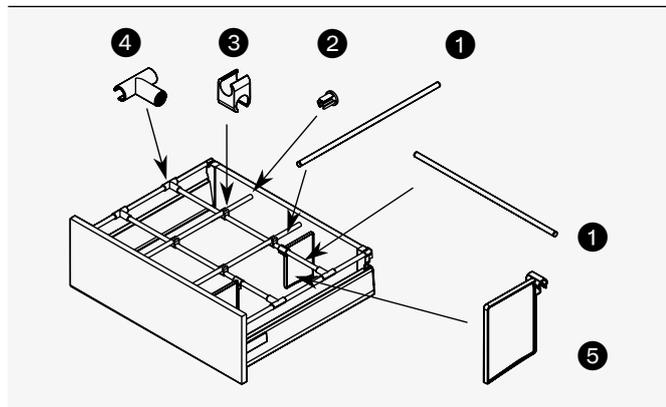

## ❶ Riex NX40 Križna pregradna relinga



○ Okrugla bijela

● Okrugla siva



○ Kvadrat bijelo

● Kvadrat siva

- Pregrada namijenjena za rezanje
- Duljina pregrade za uzdužnu upotrebu je NL-40 [NL = nominalna duljina vodilice]
- Duljina pregrade za križnu upotrebu je LW-52 [LW = unutarnja širina ormara]

Relinga oblik	Duljina [mm]	Bijela	Sivo
Okrugla	1100	F000411	F000412
Četvrtasta	1100	F000413	F000414

## ❷ Riex NX40 Završni dijelovi pregrade

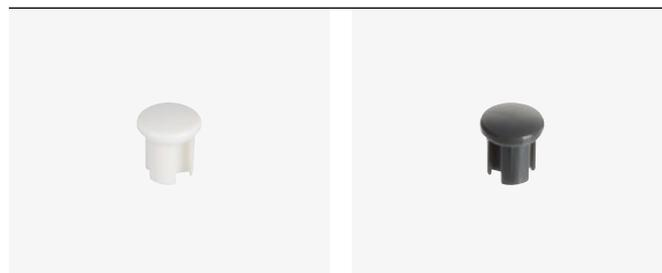

○ Okrugla bijela

● Okrugla siva

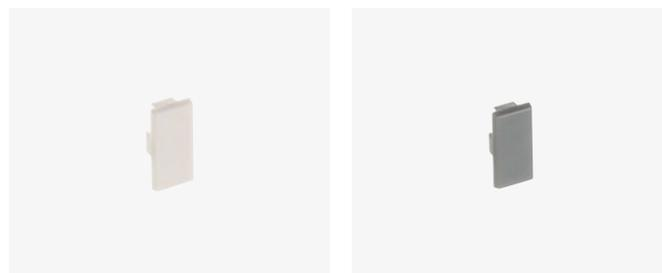

○ Kvadrat bijela

● Kvadrat siva

Relinga oblik	Bijela	Sivo
Okrugla	F000423	F000424
Četvrtasta	F000425	F000426

Zapakiran po 1 komad.

### ③ Riex NX40 Križni spoj



○ Okrugli bijela



● Okrugli sivi



○ Kvadrat bijela



● Kvadrat siva

Oblik pregrade	Bijeli	Sivi
Okrugli	F000419	F000420
Četrtasti	F000421	F000422

Zapakiran po 1 komad.

### ④ Riex NX40 T Dodatak



○ Okrugla bijela



● Okrugli sivi



○ Kvadrat bijela



● Kvadrat siva

Oblik Pregrade	Bijela	Sivo
Okrugla	F000415	F000416
Cetrtasta	F000417	F000418

Zapakiran po 1 komad.

### ⑤ Riex NX40 Razdjelna ploča



○ Bijela



● Siva

Relinga oblik	Bijela	Siva
Okrugla	F000427	F000428

Pregradna ploča samo za okrugle pregrade.

# Riex NX40

## Pribor za ladice

### ➊ Riex NX40 Poklopac bez logotipa

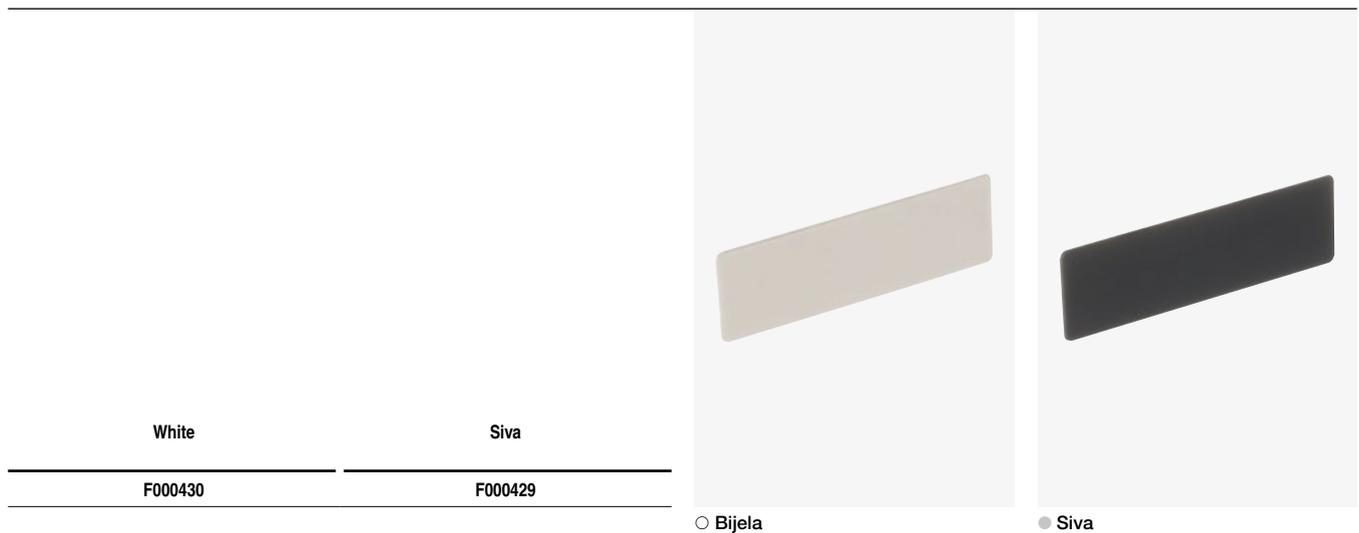

### ➋ Predložak za montažu Riex NX40

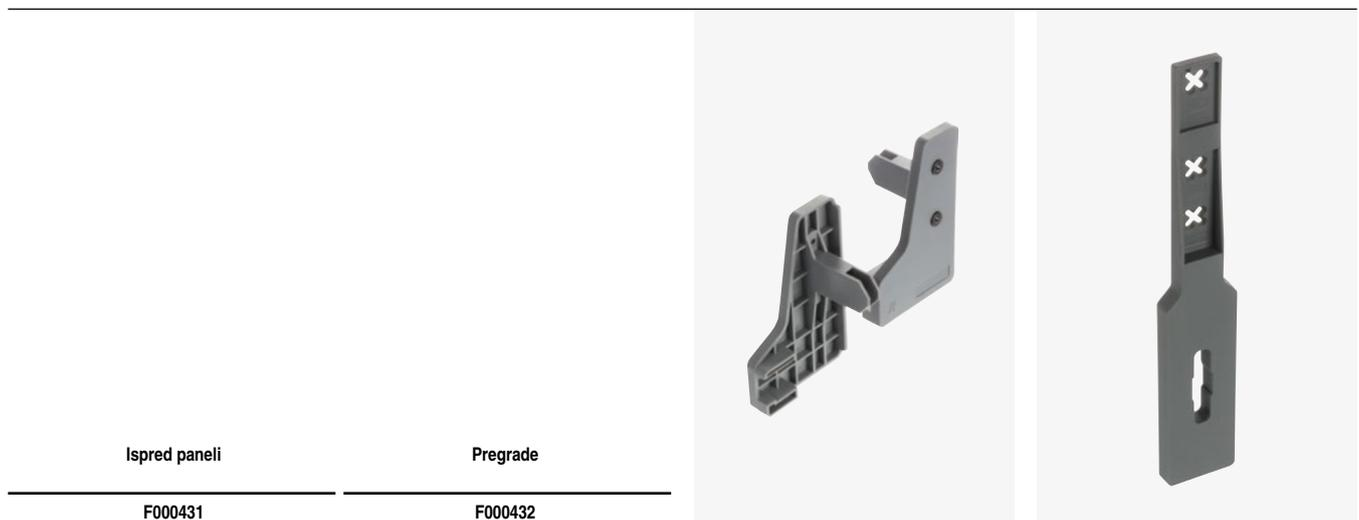

# Skrivene vodilice



# Potpuno izvlačenje

## ⊕ Riex NU80 Skrivene, klizni, potpuno izvlačenje, Soft-Close

- Nosivost 40 kg
- Izdržljivost 60 000 ciklusa
- Mehanizam za Soft-Close
- Lagan i tih rad s mekim zatvaranjem zahvaljujući sinkronizaciji
- 3D prihvatnik:
  - Podešavanje Gore / Dolje: 0 mm – 3 mm
  - Podešavanje lijevo / desno:  $\pm 2$  mm
  - Podešavanje u dubini: 0 mm – 3 mm
- Debljina bočnog materijala do 19 mm

Duljina NL [mm]	Kod
300	F000162
350	F000163
400	F000164
450	F000165
500	F000166
550	F000167
600	F000168
650	F000169

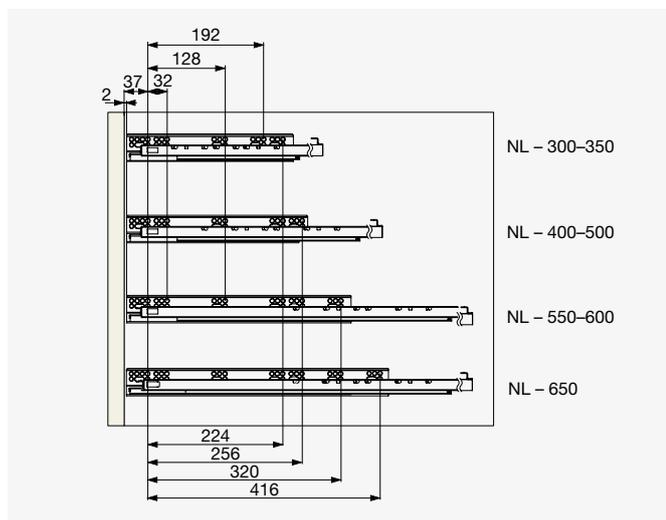
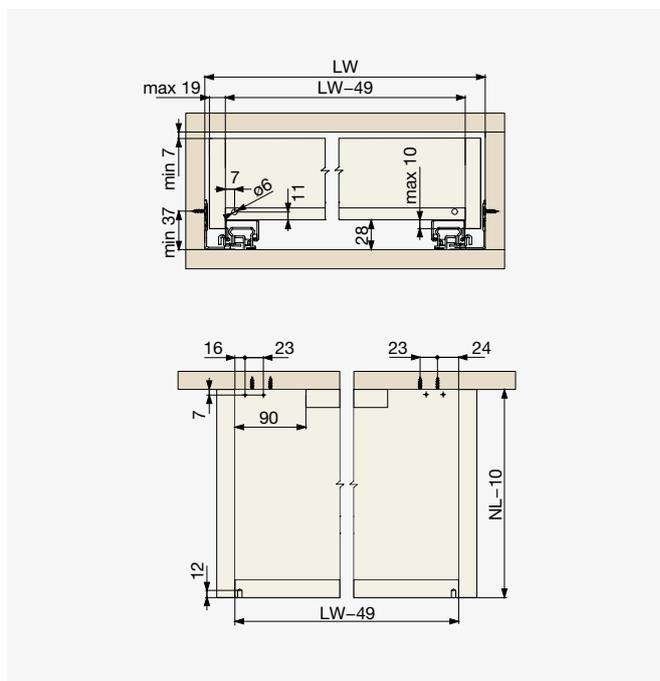
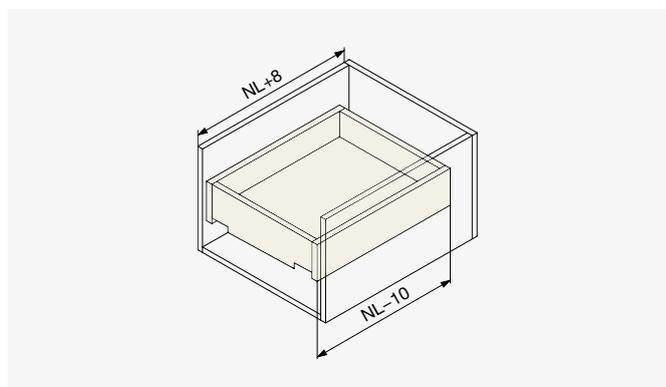

### ⊕ Legenda

- NL – nazivna duljina vodilice
- NL+8 – unutarnja dubina ormara
- NL-10 – dubina ladice
- LW – unutarnja širina ormara
- LW-49 – širina od dna ploče

## ⊕ Riex NU70 Skrivene, klizni, potpuno izvlačenje, otvaranje na pritisak

- Nosivost 35 kg
- Izdržljivost 60 000 ciklusa
- Otvaranje na pritisak
- Podesavanje sile otvaranja
- Glatki i tihi rad zahvaljujući sinkronizaciji
- 2D prihvatnik:
  - Gore / Podesavanje prema dolje: 0 mm – 3 mm
  - Podesavanje lijevo / desno:  $\pm 2$  mm
- Debljina bočnog materijala do 19 mm

Duljina NL [mm]	Kod
300	F000171
350	F000172
400	F000173
450	F000174
500	F000175
550	F000176
600	F000177
650	F000178

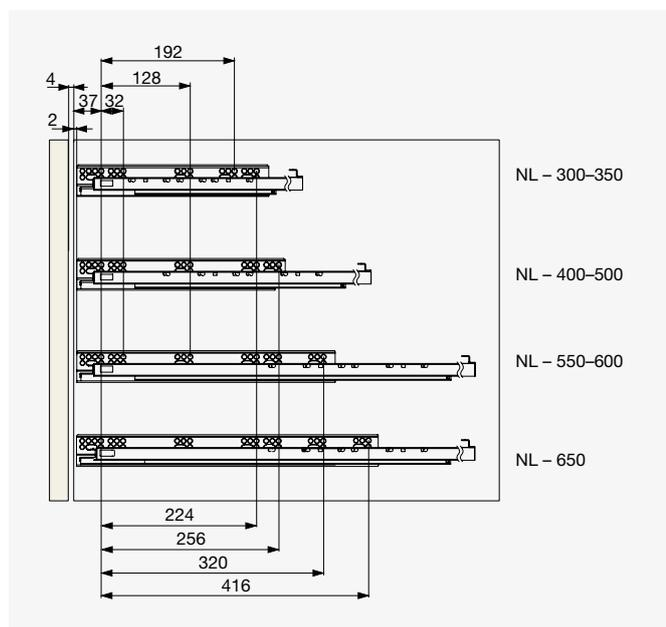
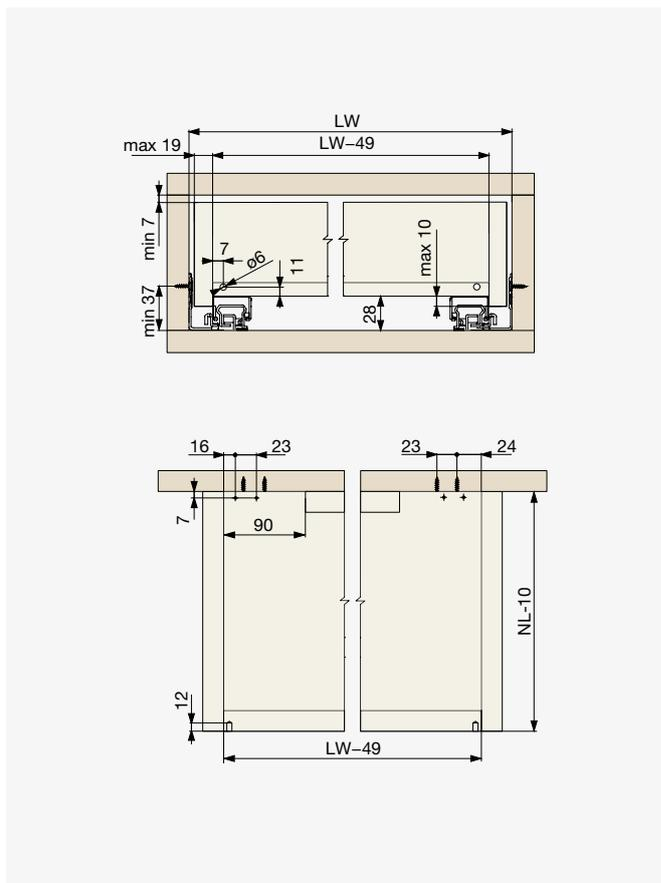
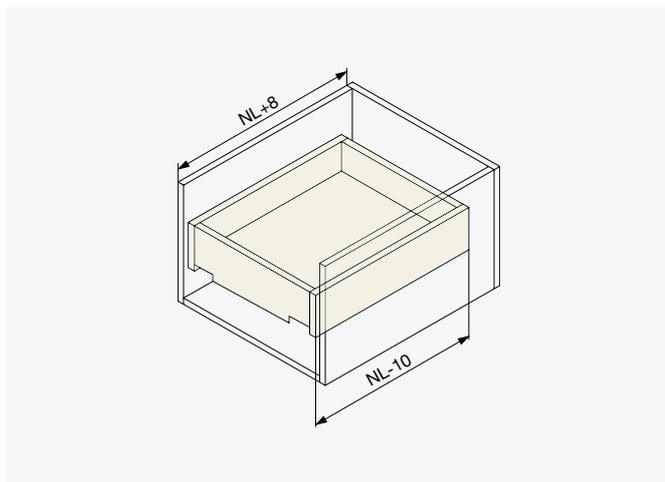

### ⊕ Legenda

- NL – nazivna duljina vodilice
- NL+8 – unutarnja dubina
- NL-10 – dubina ladice
- LW – unutarnja širina ormara
- LW-49 – širina od dna ploče

## ⊙ Riex NU69 Skrivene, klizni, Potpuno izvlačenje, Soft-Close

- Nosivost 25 kg
- Izdržljivost 50 000 ciklusa
- Mehanizam za Soft-Close
- Bez sinkronizacije
- 2D prihvatnik:
  - Gore / Podešavanje prema dolje: 0 mm – 4 mm
  - Podešavanje lijevo / desno:  $\pm 2$  mm
- Debljina bočnog materijala do 18 mm

Duljina NL [mm]	Kod
250	F000295
300	F000296
350	F000297
400	F000298
450	F000299
500	F000300
550	F000301

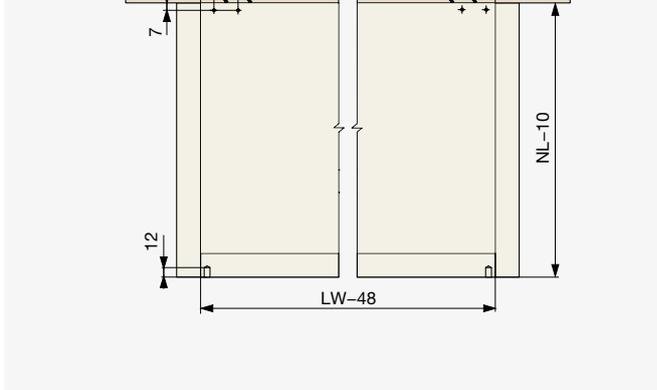
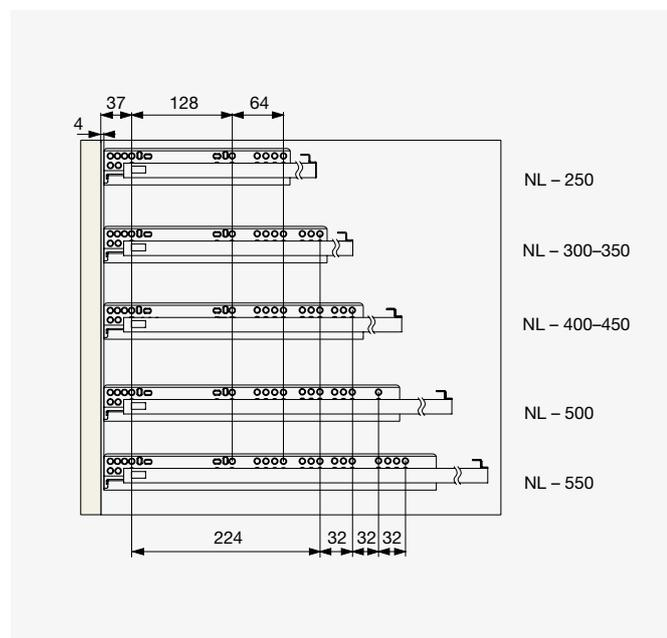
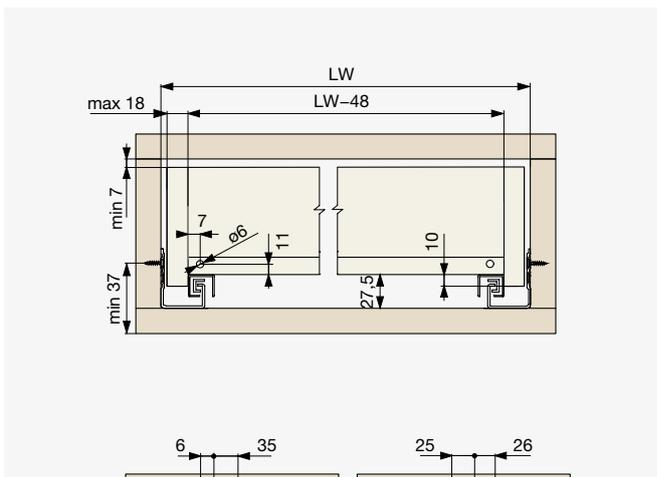
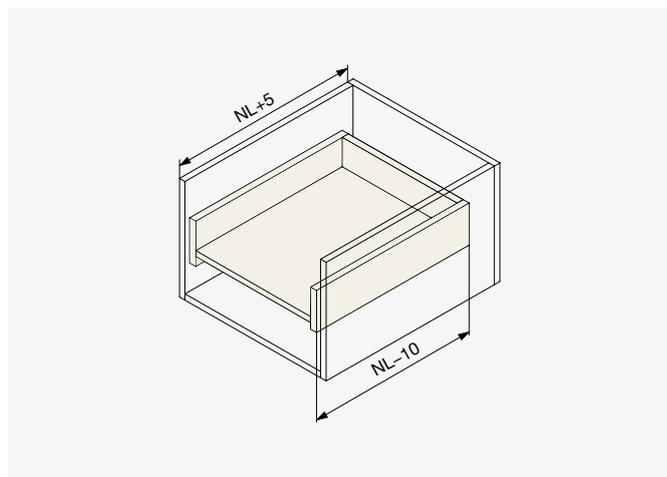

### ⊙ Legenda

- NL – nazivna duljina vodilice
- NL+5 – unutarnja dubina ormara
- NL-10 – dubina ladice
- LW – unutarnja širina ormara
- LW-48 – širina od dna ploče

# Djelomično otvaranje

## ⊕ Riex NU30 Skrivene, klizni, djelomično otvaranje, Soft-Close

- Nosivost 25 kg
- Izdržljivost 50 000 ciklusa
- Mehanizam za Soft-Close
- 2D prihvatnik:
  - Gore / Podešavanje prema dolje: 0 mm – 3 mm
  - Podešavanje lijevo / desno:  $\pm 2$  mm
- Debljina bočnog materijala do 19 mm

Duljina NL [mm]	Kod
300	F000150
350	F000151
400	F000152
450	F000153
500	F000154
550	F000155

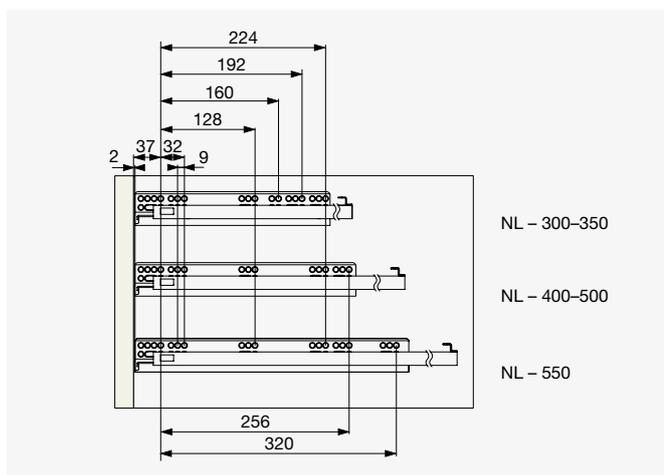
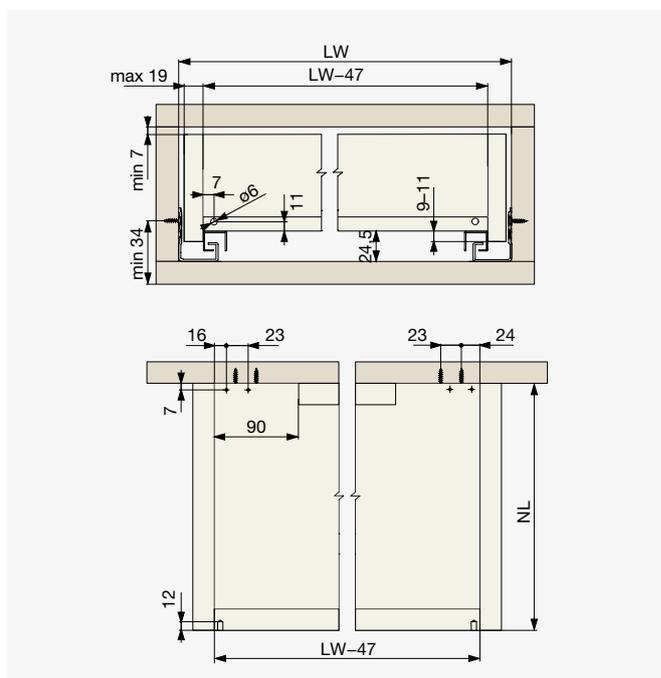
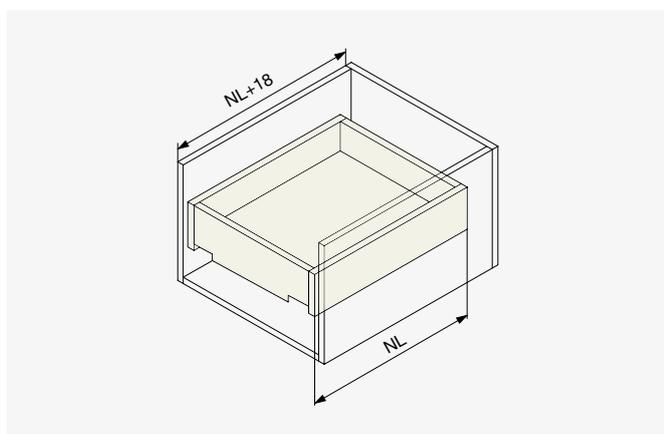

### ⊕ Legenda

- NL – nominalni duljina od dijapozitivi / dubina od ladice
- NL+18 – unutarnja dubina ormara
- LW – unutarnja širina ormara
- LW-47 – širina od dna ploče



## ⊕ Riex NU31 Skriveno klizni, djelomicno otvaranje, Soft-Close

- Nosivost 25 kg
- Izdržljivost 50 000 ciklusa
- Mehanizam za Soft-Close
- 1D prihvatnik:
  - Gore / Podešavanje prema dolje: 0 mm – 4 mm
- Debljina bočnog materijala do 18 mm

Duljina NL [mm]	Kod
300	F000282
350	F000283
400	F000284
450	F000285
500	F000286
550	F000287

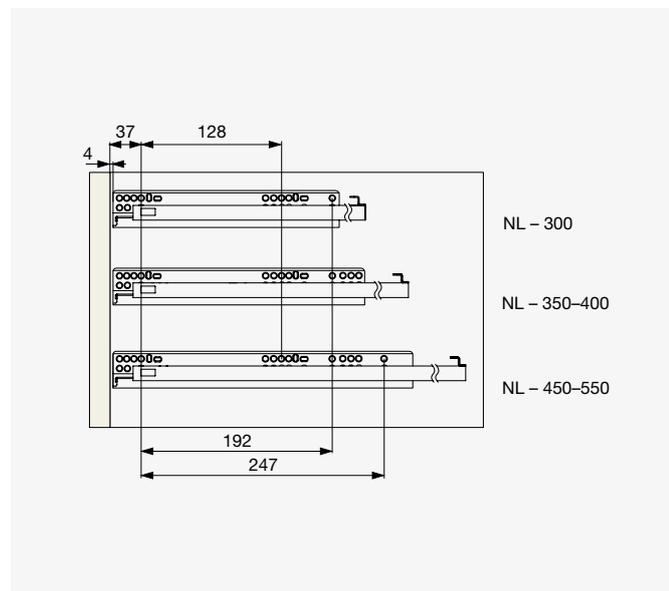
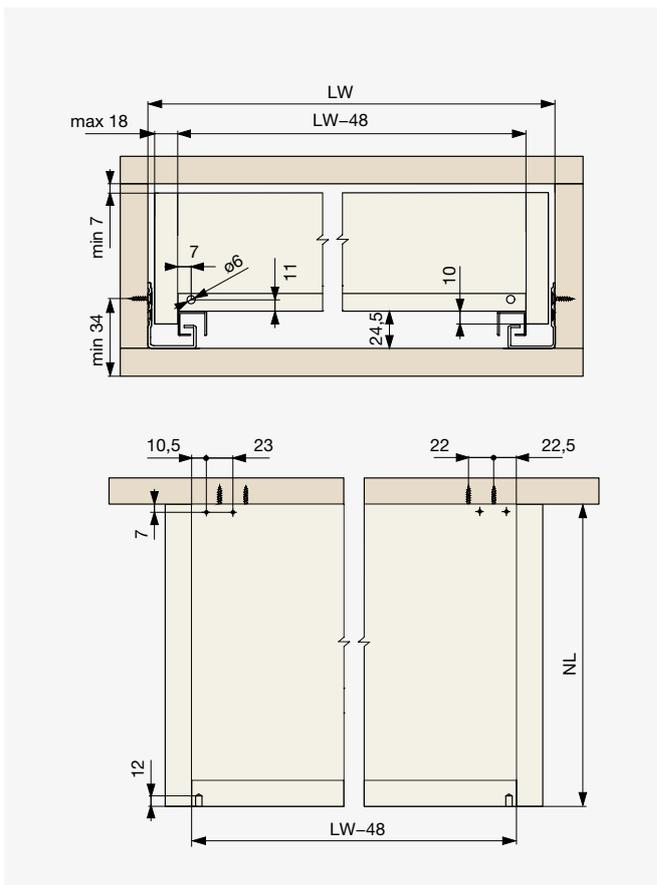
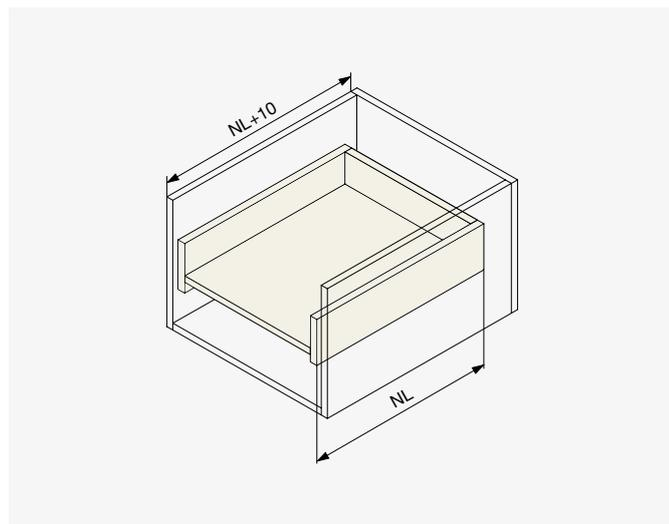

### ⊕ Legenda

- NL – nominalni duljina od dijapozitivi / dubina od ladica
- NL+10 – unutarnja dubina ormara
- LW – unutarnja širina ormara
- LW-48 – širina od dna ploča

## ⊕ Riex NU04 Skriveno klizni, jednostruki nastavak, Soft-Close

- Nosivost 25 kg
- Izdržljivost 60 000 ciklusa
- Mehanizam za Soft-Close
- 1D prihvatnik:
  - Gore / Podešavanje prema dolje: 0 mm – 2 mm
- Debljina bočnog materijala do 16 mm

Duljina NL [mm]	Kod
250	F000161
300	F000156
350	F000157
400	F000158
450	F000159
500	F000160

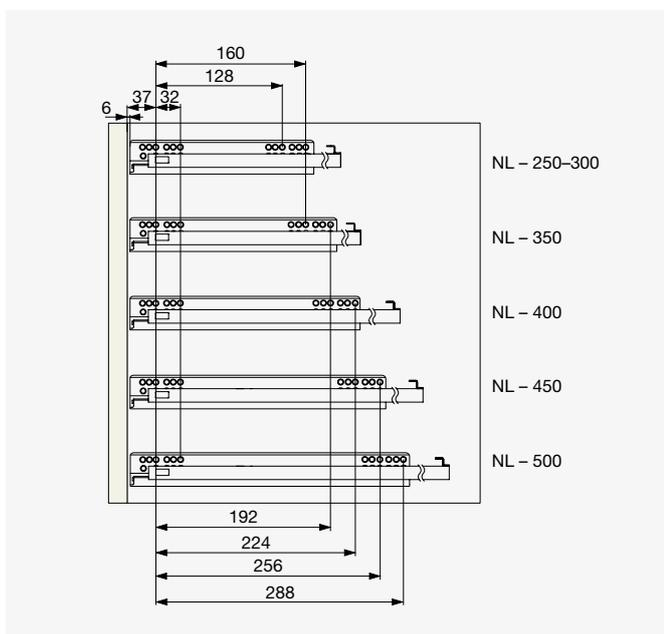
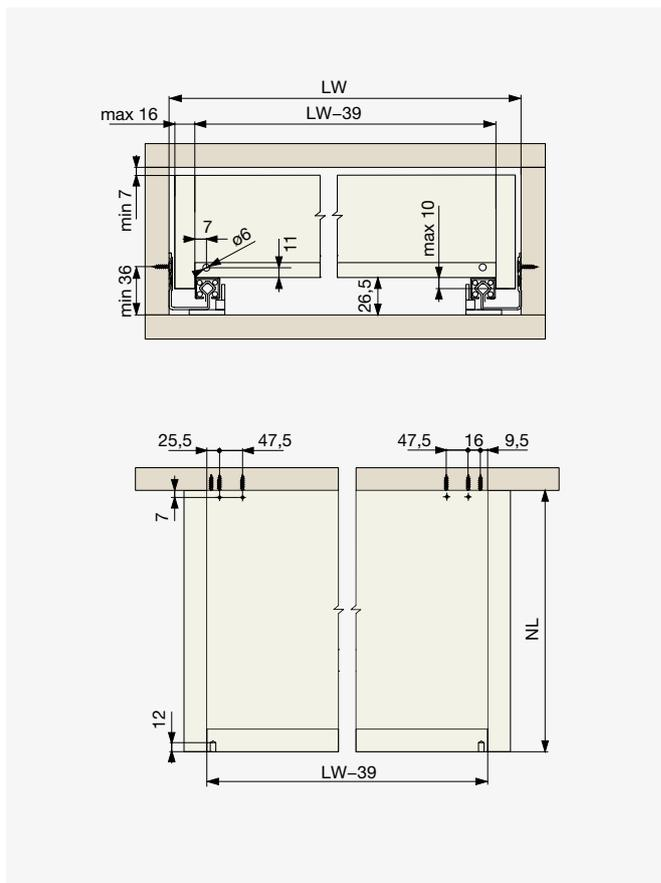
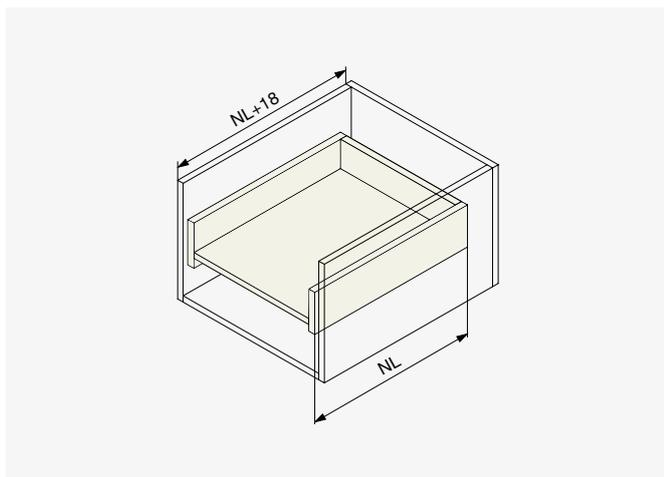

### ⊕ Legenda

- NL – nominalni duljina od dijapozitivi / dubina od ladica
- NL+18 – unutarnja dubina ormara
- LW – unutarnja širina ormara
- LW-39 – širina od dna ploča



# Kuglične vodilice



# Soft-Close

## ⊕ Riex NB58 Kuglicne vodilice 35 kg, Soft-Close

- Potpuno izvlačenje
- Nosivost 35 kg
- Visina 45,7 mm
- Debljina materijala 1,2 x 1,2 x 1,5 mm
- Izdržljivost 50 000 ciklusa



Duljina NL [mm]	Kod
300	F000808
350	F000809
400	F000810
450	F000811
500	F000812
550	F000813
600	F000814

Kod	NL [mm]	A [mm]	B [mm]	C [mm]	D [mm]	E [mm]	F [mm]	G [mm]	H [mm]	I [mm]	J [mm]	K [mm]	L [mm]	M [mm]	Nosivost [kg]
F000808	300	x	x	x	x	x	x	x	x	38	32	64	64	64	20
F000809	350	x	x	x	28	96	96	96	x	x	x	x	x	x	25
F000810	400	96	x	x	28	96	96	96	x	x	x	x	x	x	30
F000811	450	96	87	x	28	96	96	112	80	x	x	x	x	x	35
F000812	500	96	96	x	28	96	96	192	x	x	x	x	x	x	35
F000813	550	96	128	x	28	96	96	192	96	x	x	x	x	x	30
F000814	600	96	128	64	28	96	96	192	96	x	x	x	x	x	25

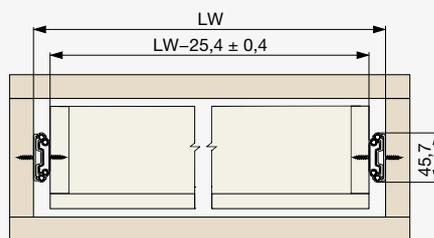
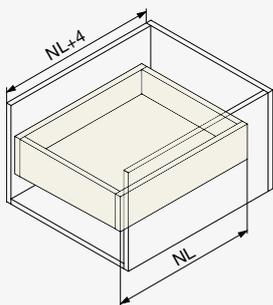

### ⊕ Legenda

NL – nominalna duljina vodilice  
 NL+4 – unutarnja dubina ormarića  
 LW – unutarnja širina ormarića  
 LW-25,4 – širina ladice

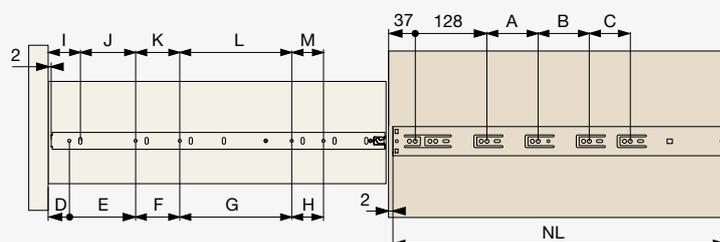

## ⊕ Riex NB48 Kuglični ležaj klizač, 30 kg, Soft-Close

- Potpuno izvlačenje
- Nosivost 30 kg
- Visina 45 mm
- Debljina materijala 1,0 × 1,0 × 1,2 mm
- Izdržljivost 50 000 ciklusa



Duljina NL [mm]	Kod
300	F002913
350	F002914
400	F002915
450	F002916
500	F002917
550	F002918

Kod	NL [mm]	A [mm]	B [mm]	C [mm]	D [mm]	E [mm]	Nosivost [kg]
F002913	300	64	x	x	64	128	16
F002914	350	96	x	x	96	128	22
F002915	400	128	x	x	128	160	26
F002916	450	128	x	x	160	160	30
F002917	500	128	64	x	160	192	30
F002918	550	128	64	96	192	224	28

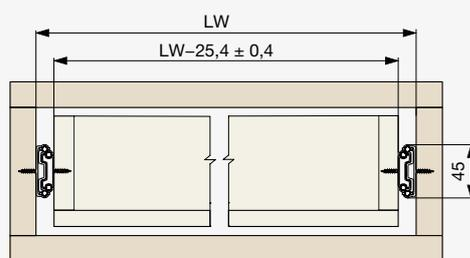
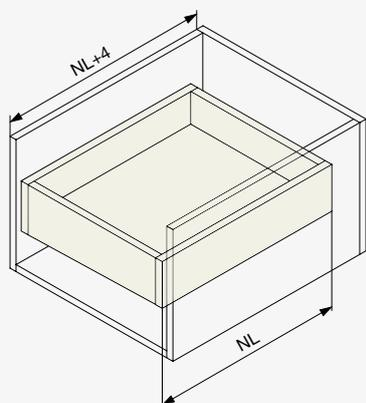

### ⊕ Legenda

NL – nominalna duljina vodilice  
 NL+4 – unutarnja dubina ormarića  
 LW – unutarnja širina ormarića  
 LW-25,4 – širina ladice

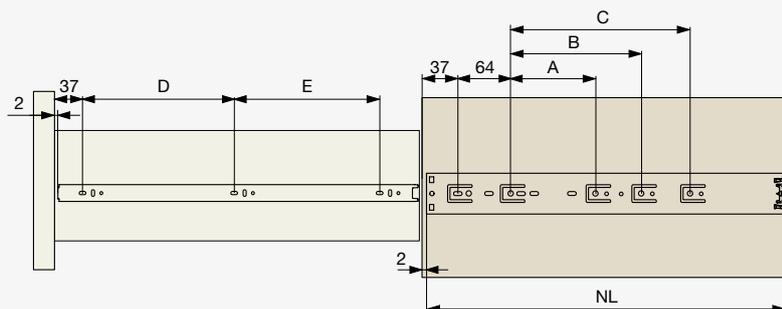

# Vodilica Push-to-Open

## ⊕ Riex NB51 Kuglični ležaj klizač, 35 kg, Push-to-Open

- Potpuno izvlačenje
- Nosivost 35 kg
- Visina 44,9 mm
- Debljina materijala 1,0 × 1,0 × 1,2 mm
- Izdržljivost 50 000 ciklusa

Duljina NL [mm]	Kod
300	F000815
350	F000816
400	F000817
450	F000818
500	F000819
550	F000820
600	F000821



Kod	NL [mm]	A [mm]	B [mm]	C [mm]	D [mm]	E [mm]	Nosivost [kg]
F000815	300	96	x	x	64	160	19
F000816	350	64	64	x	96	128	26
F000817	400	64	128	x	128	192	30
F000818	450	64	160	x	160	160	35
F000819	500	64	192	x	192	192	35
F000820	550	64	160	160	224	192	33
F000821	600	64	160	192	224	256	33

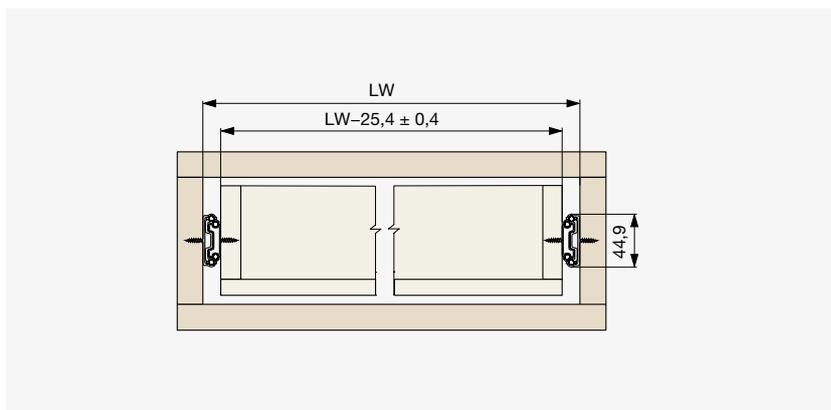
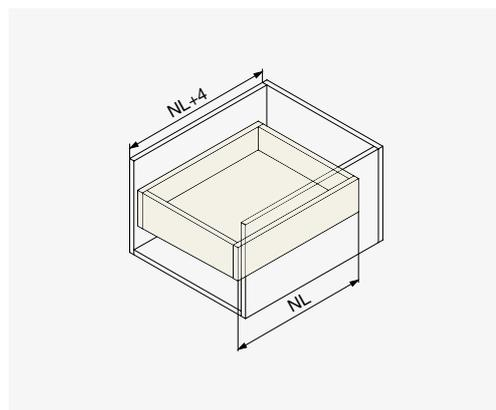

### ⊕ Legenda

- NL – nominalna duljina vodilice  
 NL+4 – unutarnja dubina ormarića  
 LW – unutarnja širina ormarića  
 LW-25,4 – širina ladice

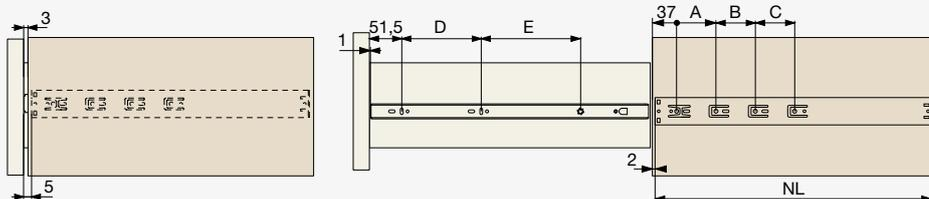

# Kuglična vodilica

## ⊕ Riex NB55 Kuglične vodilice, 45 kg

- Potpuno izvlačenje
- Nosivost 45 kg
- Visina 45,7 mm
- Debljina materijala 1,2 × 1,2 × 1,5 mm
- Izdržljivost 50 000 ciklusa

Duljina NL [mm]	Kod
250	F000798
300	F000799
350	F000800
400	F000801
450	F000802
500	F000803
550	F000804
600	F000805
650	F000806
700	F000807



Kod	NL [mm]	A [mm]	B [mm]	C [mm]	D [mm]	E [mm]	F [mm]	G [mm]	H [mm]	Nosivost [kg]
F000798	250	x	x	x	96	x	x	x	x	23
F000799	300	96	x	x	128	x	x	x	x	24
F000800	350	96	x	x	160	x	x	x	x	33
F000801	400	96	96	x	96	128	x	x	x	38
F000802	450	96	128	x	96	128	72	x	x	45
F000803	500	96	128	64	96	128	96	x	x	45
F000804	550	96	128	96	96	192	64	44	x	42
F000805	600	96	128	128	96	192	96	62	x	42
F000806	650	96	128	192	96	192	160	48	x	41
F000807	700	96	128	192	96	192	160	x	98	41

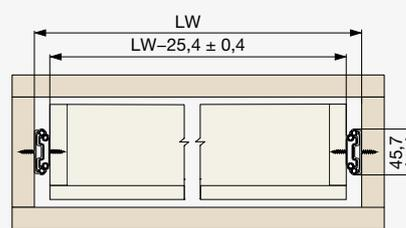
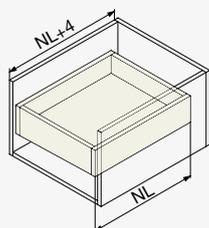

### ⊙ Legenda

NL – nominalna duljina vodilice  
 NL+4 – unutarnja dubina ormarića  
 LW – unutarnja širina ormarića  
 LW-25,4 – širina ladice

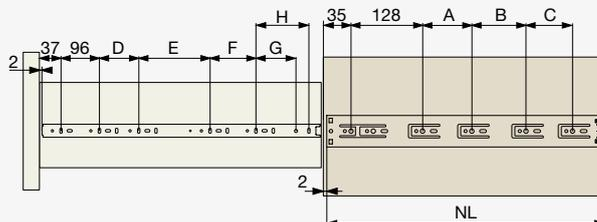



## ⊕ Riex NB45 kuglična vodilica, 30 kg

- Potpuno izvlačenje
- Nosivost 30 kg
- Visina 44,6 mm
- Debljina materijala 1,0 × 1,0 × 1,2 mm
- Izdržljivost 50 000 ciklusa



Duljina NL [mm]	Kod
300	F002906
350	F002907
400	F002908
450	F002909
500	F002910
550	F002911

Kod	NL [mm]	A [mm]	B [mm]	C [mm]	D [mm]	E [mm]	F [mm]	G [mm]	Nosivost [kg]
F002906	300	64	128	169	×	×	96	128	16
F002907	350	96	160	219	×	×	96	160	22
F002908	400	96	160	269	×	×	128	192	26
F002909	450	96	160	224	288	×	160	192	30
F002910	500	96	160	224	288	×	192	224	30
F002911	550	96	160	224	288	384	192	256	28

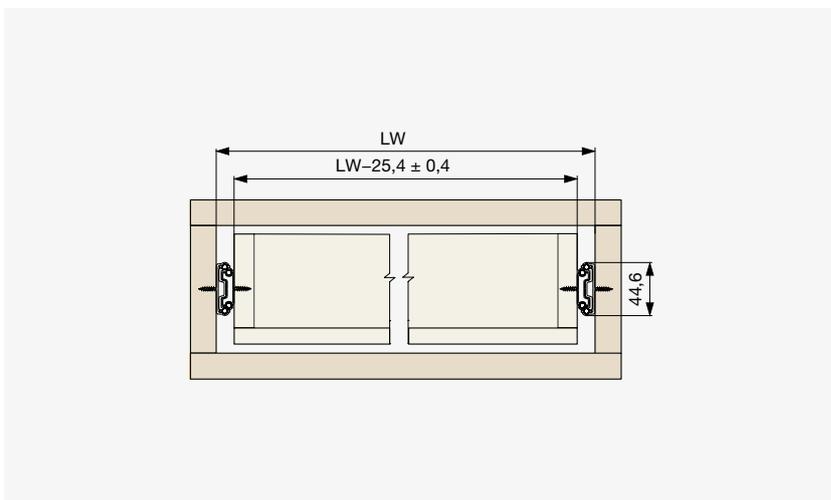
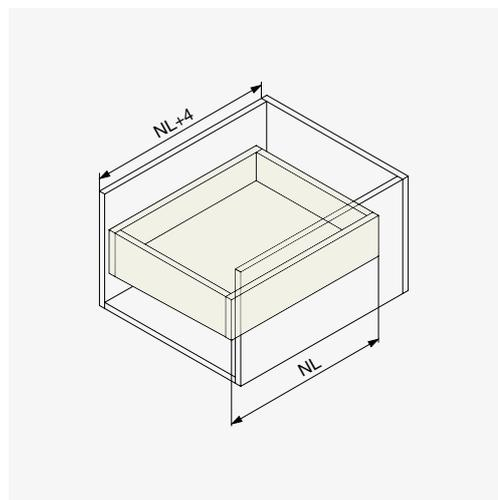

### ⊕ Legenda

- NL – nominalna duljina vodilice
- NL+4 – unutarnja dubina ormarića
- LW – unutarnja širina ormarića
- LW-25,4 – širina ladice

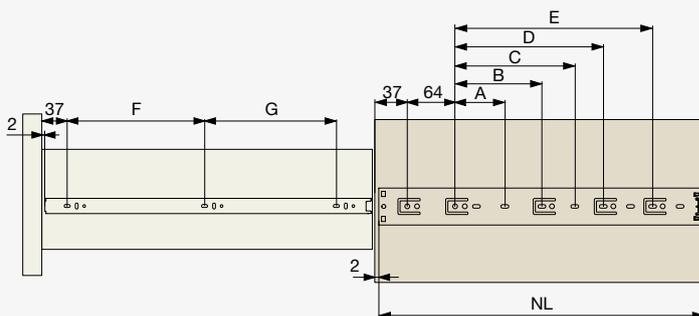

01  
02  
03  
04  
05  
06  
07  
08  
09  
10  
11  
12  
13  
14  
15  
16  
17  
18

## ⊕ Riex NB35 Kuglične vodilice, 25 kg

- Potpuno izvlačenje
- Nosivost 25 kg
- Visina 35 mm
- Debljina materijala 0,8 × 0,8 × 0,8 mm
- Izdržljivost 30 000 ciklusa



Duljina NL [mm]	Kod
250	F002920
300	F002921
350	F002922
400	F002923
450	F002924
500	F002925

Kod	NL [mm]	A [mm]	B [mm]	C [mm]	D [mm]	E [mm]	Nosivost [kg]
F002920	250	96	x	x	160	-	13
F002921	300	128	x	x	96	128	13
F002922	350	160	x	x	96	160	18
F002923	400	160	64	x	128	192	21
F002924	450	160	128	x	128	224	25
F002925	500	160	128	64	128	288	25

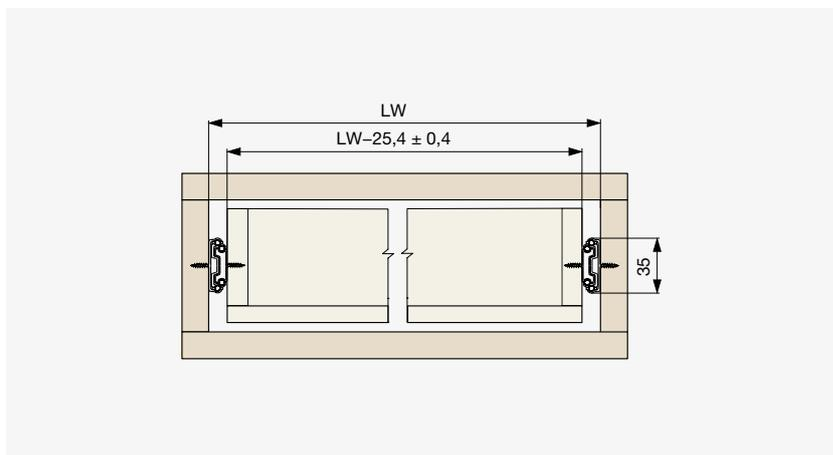
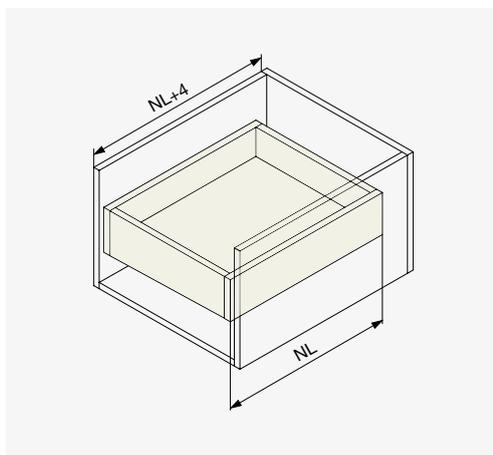

### ⊕ Legenda

NL – nazivna duljina vodilice  
 NL+4 – unutarnje kabinet dubina  
 LW – unutarnja širina ormara  
 LW-25,4 – širina ladice

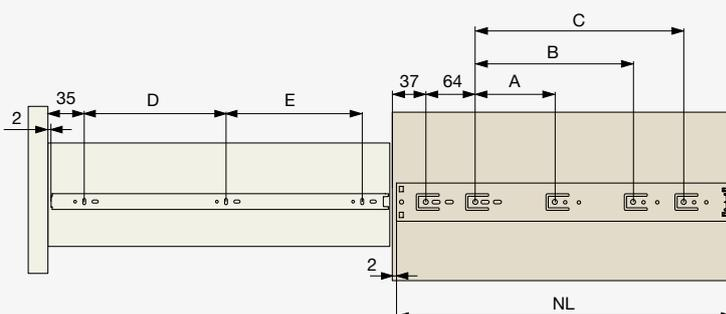

## ⊕ Riex NB17 Kuglične vodilice, 10 kg

- Jednostruki nastavak
- Nosivost 10 kg
- Visina 16,8 mm
- Debljina materijala 1,0 × 1,0 mm
- Izdržljivost 10 000 ciklusa
- Vodilica za montažu u glodane uture



Duljina NL [mm]	Kod
246	F000367
278	F000368
310	F000369
342	F000370

Kod	NL [mm]	NL1 [mm]	Nosivost [kg]
F000367	246	156	10
F000368	278	203	10
F000369	310	212	10
F000370	342	245	10

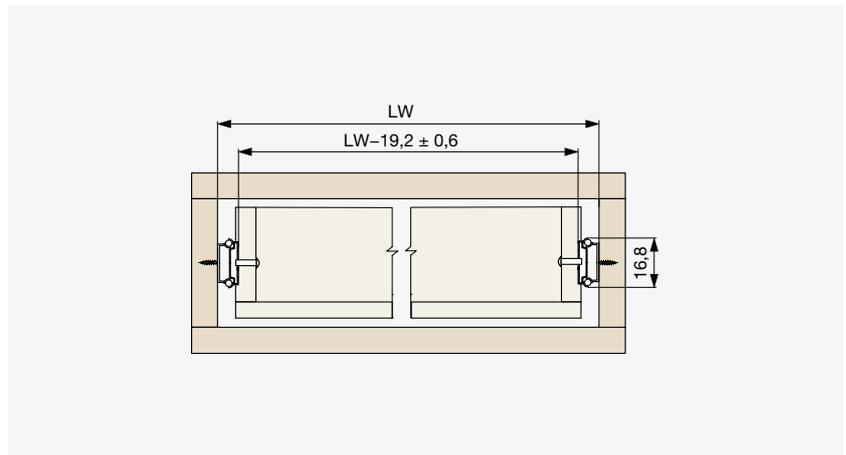
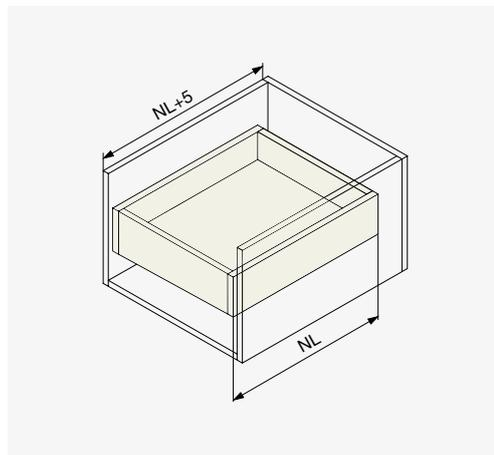

### ⊕ Legenda

- NL – nazivna duljina vodilice
- NL+5 – unutarnje kabinet dubina
- LW – unutarnja širina ormara
- LW-19,2 – širina ladice
- NL<sub>1</sub> – duljina izbočine

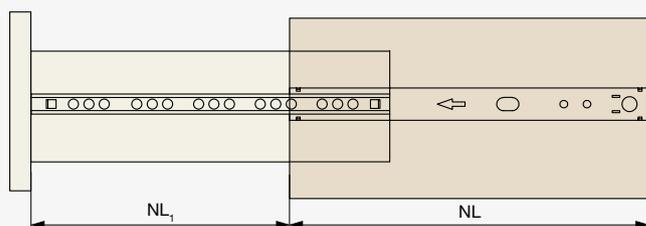

## ⊕ Riex NB75 Kuglične vodilice, 120 kg

- Potpuno izvlačenje
- Nosivost 120 kg
- Visina 58 mm
- Debljina materijala 2,0 × 2,0 × 2,2 mm
- Izdržljivost 30 000 ciklusa



Duljina NL [mm]	Kod
800	F005162
900	F005163
1000	F005164
1200	F005165

Kod	NL [mm]	A [mm]	B [mm]	C [mm]	D [mm]	E [mm]	F [mm]	G [mm]	Nosivost [kg]
F005162	800	128	192	160	128	224	256	192	120
F005163	900	128	256	160	160	224	288	256	110
F005164	1000	160	288	160	192	256	320	288	100
F005165	1200	160	288	256	256	256	352	384	90

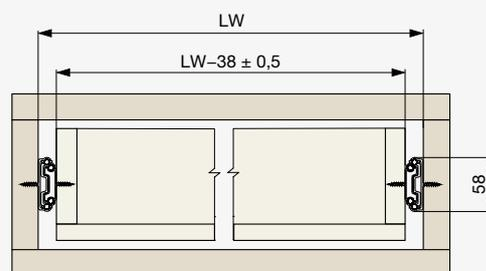
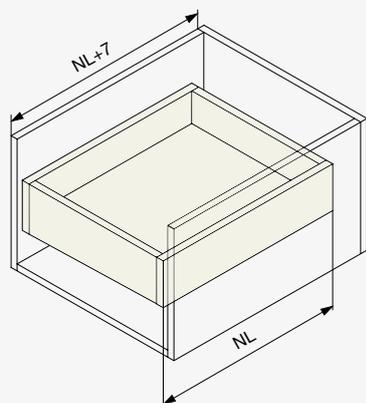

### ⊕ Legenda

NL – nazivna duljina vodilice  
 NL+7 – unutarnje kabinete  
 LW – unutarnja širina ormara  
 LW-38 – širina ladice

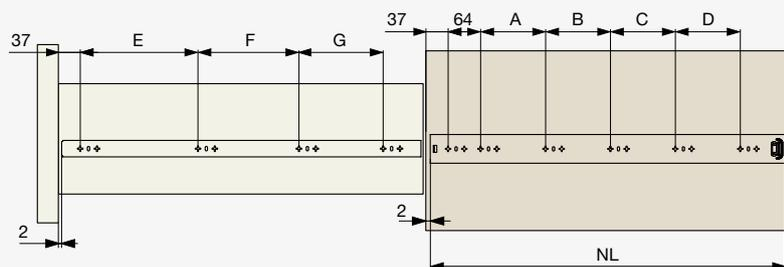



# Vodilice



## ⊕ Riex NP11 Metalbox visina 54 mm

- Nosivost 25 kg
- Dno i stražnja ploča zgrade su integrirane na bočnim stijenkama
- Dodatni sustav Soft-Close-a na str. 1.60
- Prednja ploča prilagodba u okomitom smjeru:
  - Podešavanje gore / dolje:  $\pm 2$  mm



○ Bijelo



● Siva

Duljina NL [mm]	Bijela	Sivo
450	F003016	F003018
500	F003017	F003019

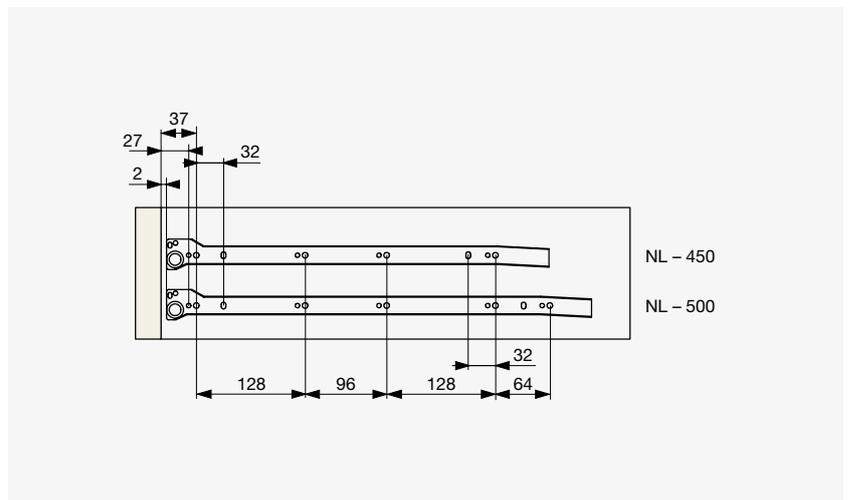
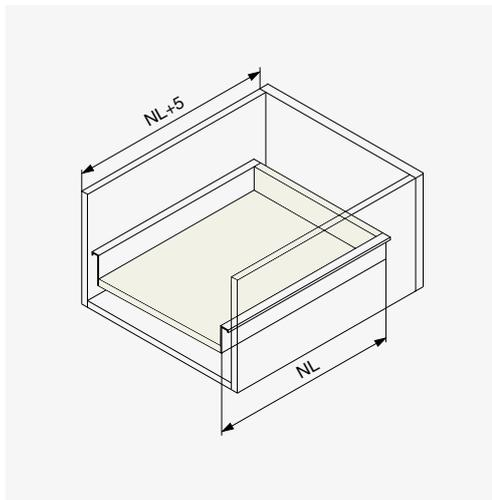

### ⊕ Legenda

NL – nazivna duljina vodilice  
 NL+5 – unutarnja dubina ormara  
 LW – unutarnja širina ormara  
 LW-31 – širina od dno ploča /  
 širina stražnje ploče

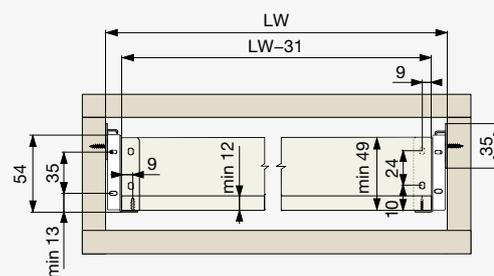





## ⊙ Riex NP11 Ladica sa metalnom kutijom, visina 118 mm

- Nosivost 25 kg
- Dno i stražnja ploča zgrade su integrirane na bočnim stijenkama
- Dodatno vanjsko Soft-Close sustav na str. 1.60
- Prednja ploča prilagodba u vertikalni smjer:
  - Podešavanje gore / dolje:  $\pm 2$  mm



○ Bijelo



● Siva

Duljina NL [mm]	Bijela	Siva
350	F000754	F000774
400	F000755	F000775
450	F000756	F000776
500	F000757	F000777

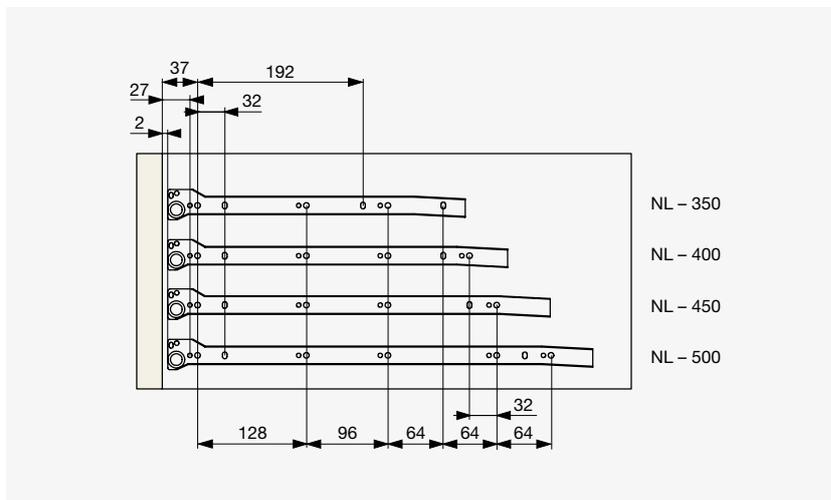
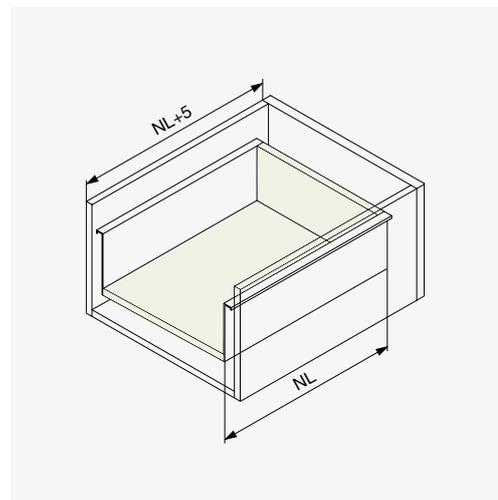

### ⊙ Legend

- NL – nazivna duljina vodilice
- NL+5 – unutarnja dubina ormara
- LW – unutarnja širina ormara
- LW-31 – širina od dno ploča / širina stražnje ploče

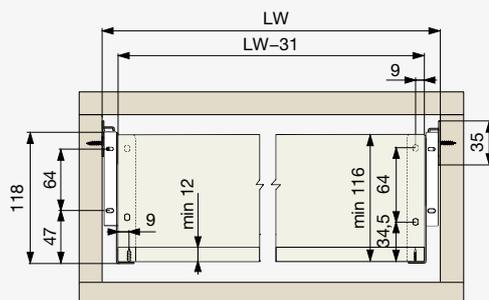

01  
02  
03  
04  
05  
06  
07  
08  
09  
10  
11  
12  
13  
14  
15  
16  
17  
18



## ⊕ Riex NP11 Metalbox reling



○ Bijela



● Sivo

Duljina [mm]	Bijela	Sivo
300	F000786	F000792
350	F000787	F000793
400	F000788	F000794
450	F000789	F000795
500	F000790	F000796
550	F000791	F000797

Sadrži par okruglih relinga i stražnje zgrade.

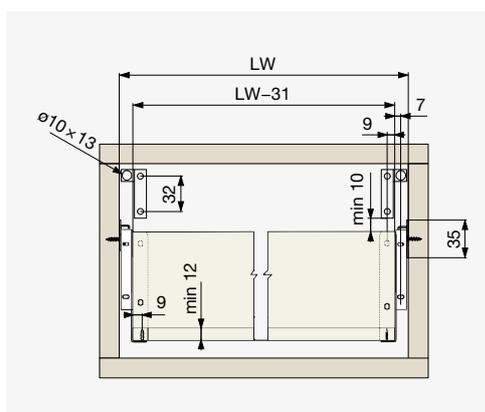

### ⊕ Legenda

LW – unutarnja širina ormara  
LW-31 – širina od dna ploča / širina stražnje ploče

## ⊕ Riex NP11 Metalna kutija, sustav Soft-Close-a

- Set lijevog i desnog prigušivača i šablona za montažu



Upišite

Kod

Za metal kutija

F005167

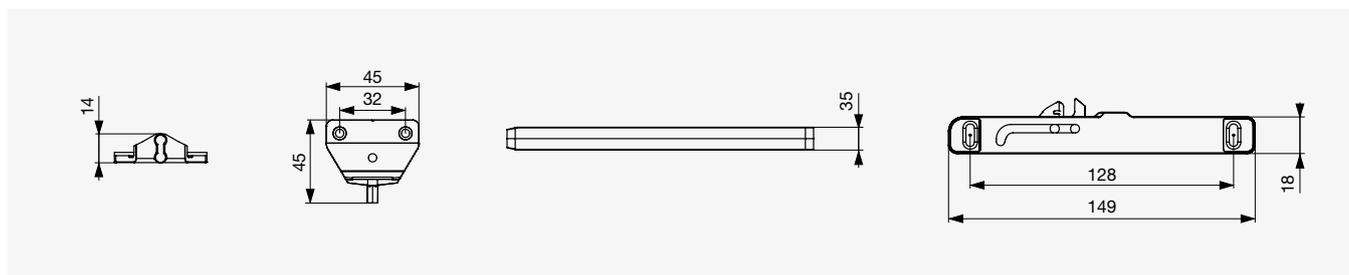

01  
02  
03  
04  
05  
06  
07  
08  
09  
10  
11  
12  
13  
14  
15  
16  
17  
18

# Vodilica



## ➤ Riex NR09 Vodilica

- Nosivost 20 kg

Duljina NL [mm]	Bijela	Smeda	Crna
250	F000545	F000553	F000561
300	F000546	F000554	F000562
350	F000547	F000555	F000563
400	F000548	F000556	F000564
450	F000549	F000557	F000565
500	F000550	F000558	F000566
550	F000551	×	×
600	F000552	×	×



○ Bijela



● Smeda



● Crna

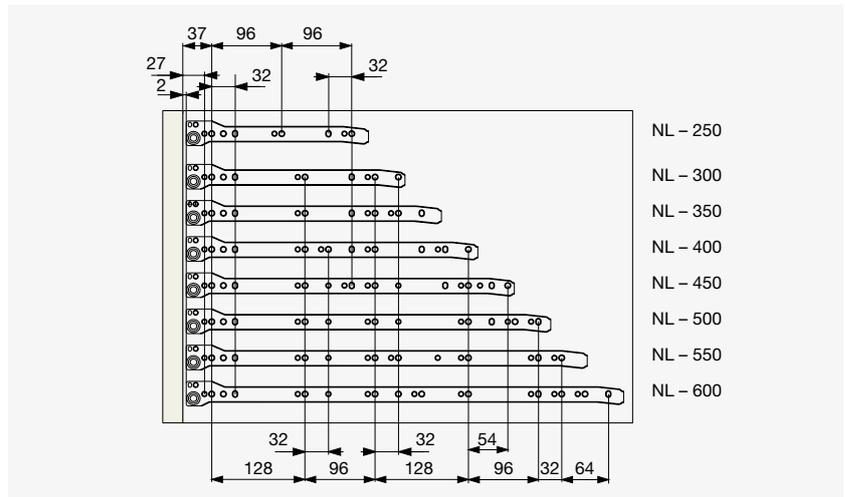
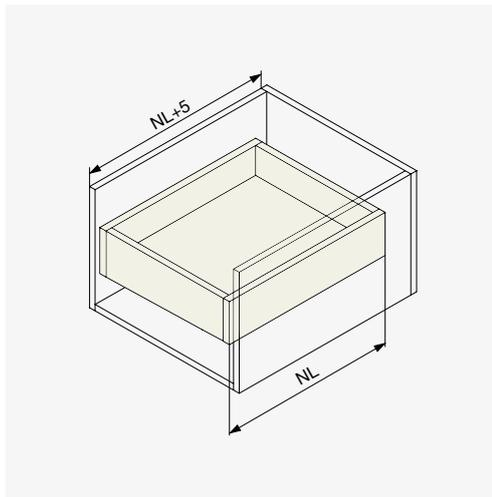

#### Legend

NL – nazivna duljina vodilice  
 NL+5 – unutarnje kabinet dubina  
 LW – unutarnja širina ormara  
 LW-25 – širina ladice

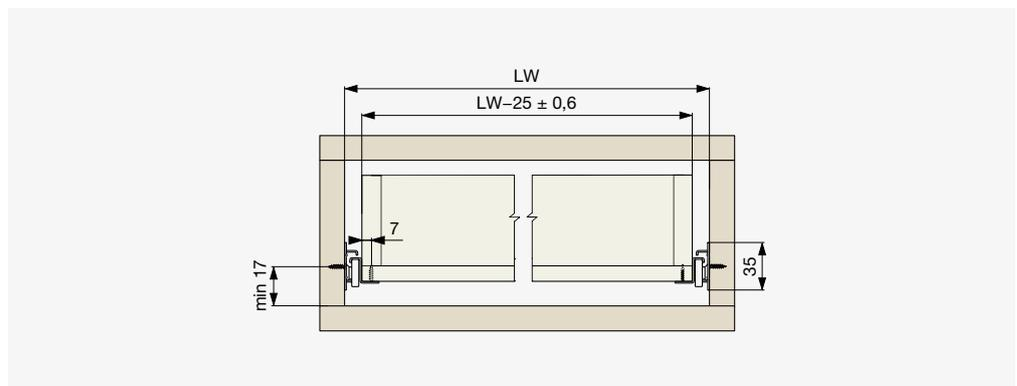

## Riex NR09 Vodilica vanjski usporivač

- Set lijevog i desnog prigušivača i šablona za montažu



Upišite

kod

Za klizač s valjcima

F005166

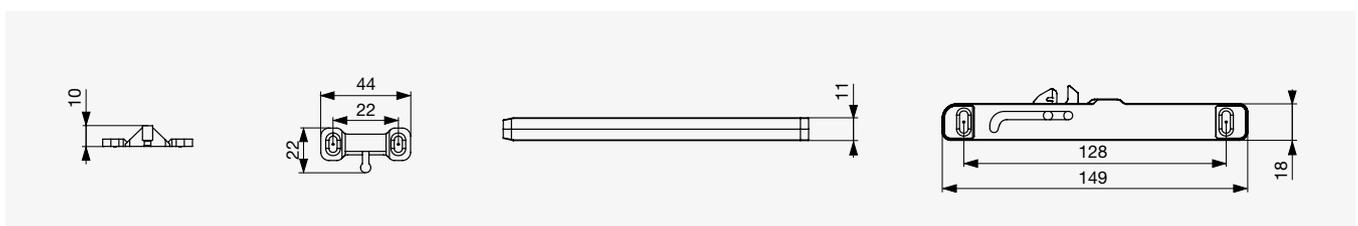

# Spojnice i Push-to-Open mehanizmi otvaranja

Spojnice su neizostavno rješenje za namještaj s vratima, bez obzira na smjer otvaranja. Najveća grupa spojnica u našoj ponudi su preklopne spojnice. Vrhunski model ove serije je robusna serija NC70, koja nudi vrlo visoku izdržljivost i dug životni vijek. Izvrsno prigušivanje, spojni mehanizmi, sa širokim rasponom rješenja i dodatka korisnih za ovu seriju. Osim preklopnih okova, ovaj odjeljak također uključuje spojnice za posebne primjene push to open spojnice za otvaranje bez ručke.



● Riex Raspon preklopnih spojnica	2.3
● Riex NC70 / NC50 Preklopne spojnice	2.5
Riex NC70 spojnice	2.6
Riex NC50 spojnice	2.13
Riex NC70 / NC50 Montažne pločice i dodaci	2.15
● Riex NC40 Preklopne spojnice	2.17
Riex NC40 spojnice	2.17
Riex NC40 Montažne pločice i dodaci	2.24
● Riex NC20 Preklopne spojnice	2.25
● Riex NS40 Klizna spojnica	2.27
Riex NS40 spojnice	2.27
Riex NS40 Montažne pločice	2.29
● Riex NS20 / NS10 Klizna spojnica	2.30
● Riex NS30 Mini klizna spojnica	2.33
● Ostale spojnice	2.35
● Amortizeri	2.40
● Push-to-Open spojnice	2.41
Riex Otvaranje na dodir	2.41
IF K Otvaranje na dodir	2.43

# Riex Spojnice

## Clip on

- Sustav za praktično pričvršćivanje i skidanje spojnice s montažne pločice
- Podešavanje položaja u jednom koraku

## Klizna spojnica

- Spoj između okova i montažne pločice mora biti pričvršćen vijkom
- Niža cijena u odnosu na verziju CLIP-ON
- Zahtijeva podešavanje u više koraka i manju udobnost postavljanja

## Clip-On spojnica



	NC70	NC50	NC40	NC20
Životni ciklusi trajnosti	●●●●●	●●●●●	●●●●	●●●
Cijena	€€€	€€€	€€	€€
Širina raspona	●●●●●	●●	●●●●●	●
Funkcionalnost	●●●●●	●●●●●	●●●●	●●●

## Klizne spojnice



	NS40	NS20	NS10
Životni ciklusi trajnosti	●●●	●●	●
Cijena	€€	€	€
Širina raspona	●●	●	●
Funkcionalnost	●●	●	●



# Osnovne značajke spojnica

## Bušenje otvora za šarku 35 mm

- Sve spojnice imaju isti model bušenja
- Postoje tri načina povezivanja:
  - Pričvršćivanje vijcima
  - Eurovijci – zahtijevaju prethodno bušenje
  - Tiple – zahtijeva prethodno bušenje
- Vrijednost K navedena je za svaku šarku u zasebnoj tablici
- Za mini spojnice postoji različit promjer rupe za šarku  $\varnothing 26$ . Vidi str. 2.33

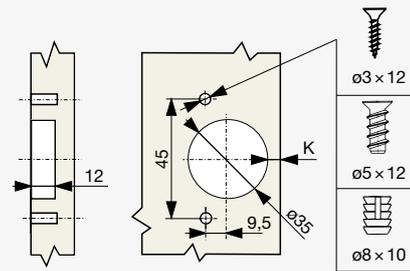

## Broj šarki

- Za fiksiranje viših vrata treba koristiti više šarki
- Maksimalna širina vrata je 600 mm

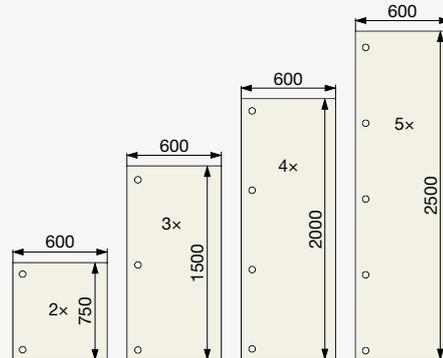

## Podješavanje spojnice

- Sve spojnice mogu bit podešene u 3 smijera
- Koristite CAM vijke u spojnicama i montažnim pločama za lakše podešavanje

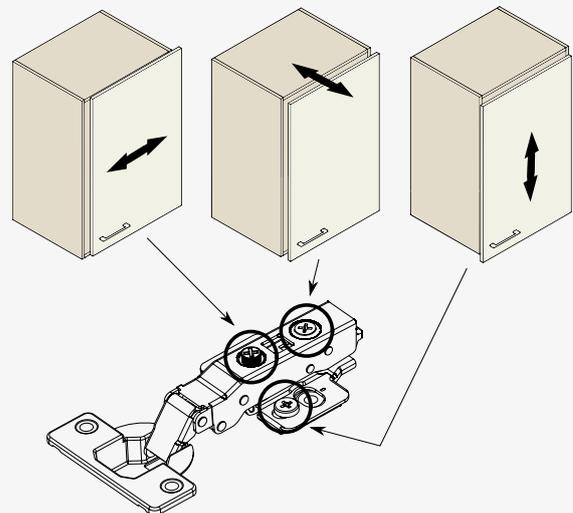

# Riex NC70 / NC50 Preklopne spojnice

- Preklopni mehanizam
- Ravan dizajn CAM vijka [za TOP modele]
- Dugi čelični prigušivač
- Dostupne također sa rješenjem "Brzo montiranje" tj. QuickMount
- Širok raspon šarki



## ⊕ Riex NC70 Spojnica, ravna



Tip	Kod
Soft-Close	F000001
Bez Soft-Close-a	F000006
Bez opruge [Push-to-Open]	F000007

ⓘ s. 2.7

Preporučene montažne pločice:

- F000043 H0 navrtanje sa CAM
- F000046 H0 navrtanje

Druge montažne pločice i poklopci NC70 / NC50 na strani 2.15.

## ⊕ Riex NC70 Spojnica, ravna, Brza montaža ø8 mm



Tip	Kod
Soft-Close	F000017

ⓘ s. 2.7

Preporučene montažne pločice:

- F000043 H0 navrtanje sa CAM
- F000046 H0 navrtanje

Druge montažne pločice i poklopci NC70 / NC50 na strani 2.15.  
Bušenje za brzu montažu ø8 x 10 mm



## ⊕ Riex NC70 Spojnica, ravna, Set od 2 komada

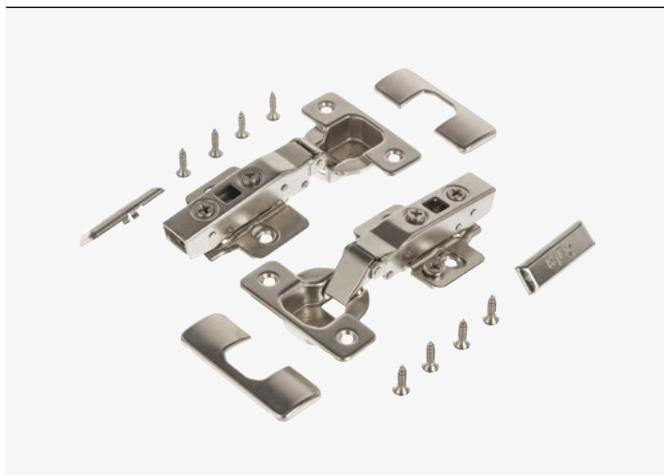

Tip	Kod
Soft-Close	F000015

ⓘ s. 2.7

Sadrži:

- 2 komada šarki
  - 2 komada montažne pločice H0 navrtanje sa CAM
  - 2 komada poklopca za pločicu
  - 2 komada poklopca za šarku
- Pakirano u vrećici za maloprodaju.

## ⊕ Riex NC70 Spojnica, potpuno preklapanje, + pločica H0



Tip	Kod
Soft-Close	F000016

ⓘ s. 2.7

**Sadrži:**

- 1 komad spojnice
- 1 komade montažne pločice H0 navrtanje

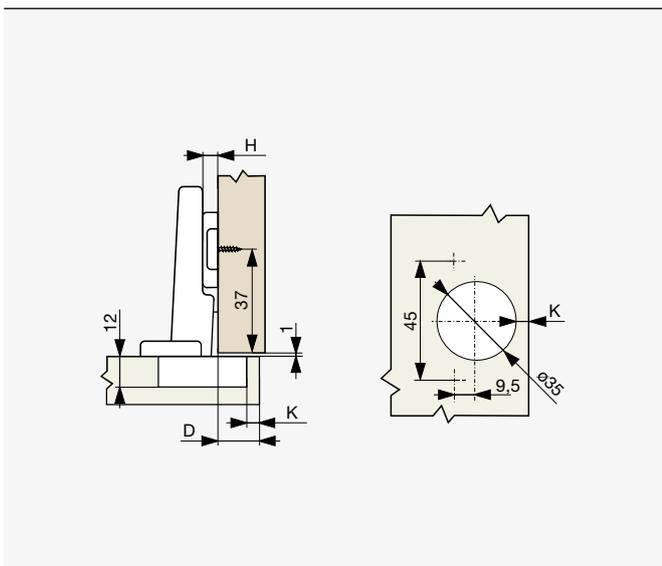

## ⓘ Riex NC70 Spojnica, potpuno preklapanje

- Crtež i tablica vrijede za proizvod na str. 2.6 i 2.7

K [mm]	Pločica H0	Pločica H2	Pločica H4
	D [mm]	D [mm]	D [mm]
4	15	13	11
5	16	14	12
6	17	15	13

Podješavanje ± 3 mm

## ⊕ Riex NC70 Spojnica, polu kriva



Tip	Kod
Soft-Close	F000008
Bez Soft-Close-a	F000009
Bez opruge [Push-to-Open]	F000010

### Preporučene montažne pločice:

- F000043 H0 navrtanje sa CAM
- F000046 H0 navrtanje

Druge montažne pločice i poklopci NC70 / NC50 na strani 2.15.

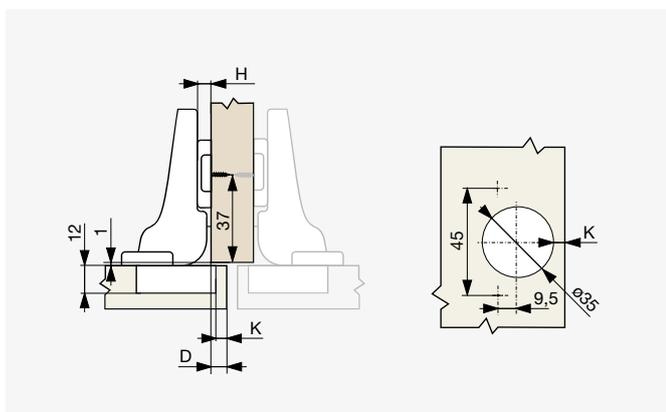

K [mm]	Pločica H0	Pločica H2	Pločica H4
	D [mm]	D [mm]	D [mm]
4	6	4	2
5	7	5	3
6	8	6	4

Podješavanje  $\pm 3$  mm.

## ⊕ Riex NC70 kriva



Tip	Kod
Soft-Close	F000011
Bez Soft-Close-a	F000012
Bez opruge [Push-to-Open]	F000013

### Preporučene montažne pločice:

- F000043 H0 navrtanje sa CAM
- F000046 H0 navrtanje

Druge montažne pločice i poklopci NC70 / NC50 na strani 2.15.

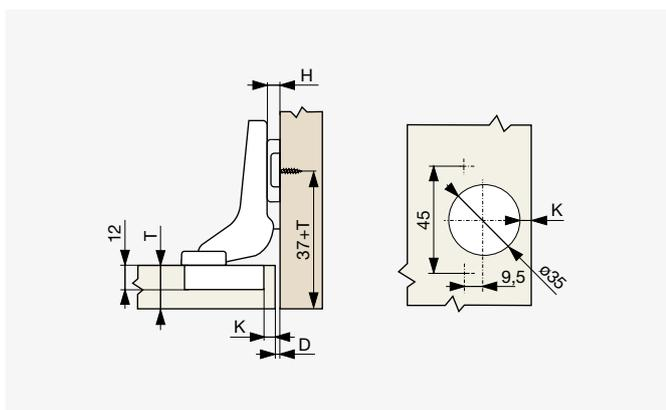

K [mm]	Pločica H0	Pločica H2	Pločica H4
	D [mm]	D [mm]	D [mm]
3	4	6	8
4	3	5	7
5	2	4	6
6	1	3	5
7	0	2	4

Podješavanje  $\pm 3$  mm

### ⊕ Riex NC70 Spojnica 155°, potpuno preklapanje s nultom izbočinom



Tip	Kod
Soft-Close	F000027
Bez opruge [Push-to-Open]	F000029

Funkcija nulte izbočine čini ove spojnice prikladnima za korištenje s unutarnjim ladicama i košarama na izvlačenje.

Preporučene montažne pločice:

- F000043 H0 navrtanje sa CAM
- F000046 H0 navrtanje

Druge montažne pločice i poklopci NC70 / NC50 na strani 2.15.

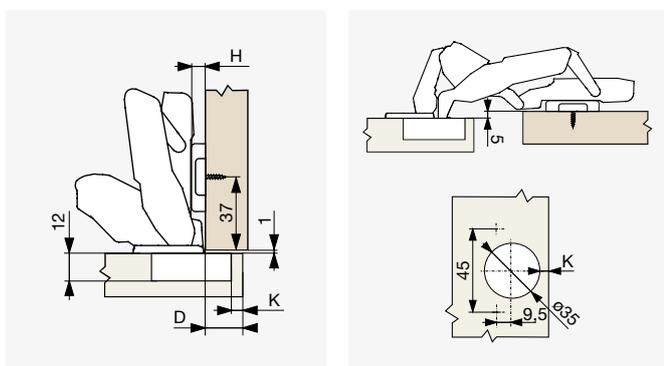

K [mm]	Pločica H0	Pločica H2	Pločica H4
	D [mm]	D [mm]	D [mm]
4	15	13	11
5	16	14	12
6	17	15	13

Podješavanje ± 2 mm.

### ⊕ Riex NC70 Spojnica 165°, djelomično preklapanje



Tip	Kod
Soft-Close	F000030
Bez opruge [Push-to-Open]	F000031

Preporučene montažne pločice:

- F000043 H0 navrtanje sa CAM
- F000046 H0 navrtanje

Druge montažne pločice i poklopci NC70 / NC50 na strani 2.15.

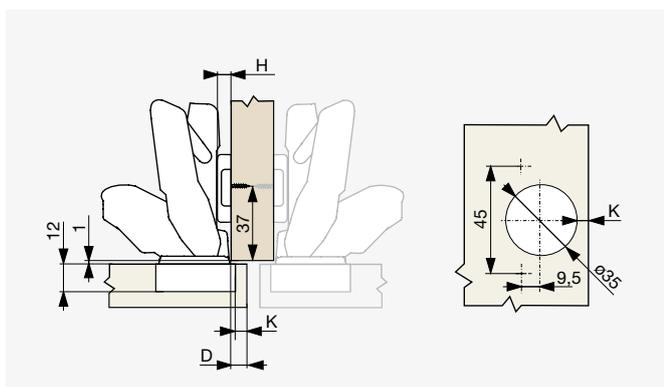

K [mm]	Pločica H0	Pločica H2	Pločica H4
	D [mm]	D [mm]	D [mm]
4	6	4	2
5	7	5	3
6	8	6	4

Podješavanje ± 2 mm.

## ⊕ Riex NC70 Umetnuta spojnica 165°



Tip

Kod

Soft-Close

F000032

Bez opruge [Push-to-Open]

F000033

Preporučene montažne pločice:

- F000044 H2 navrtanje sa CAM
- F000047 H2 navrtanje

Druge montažne pločice i poklopci NC70 / NC50 na strani 2.15.

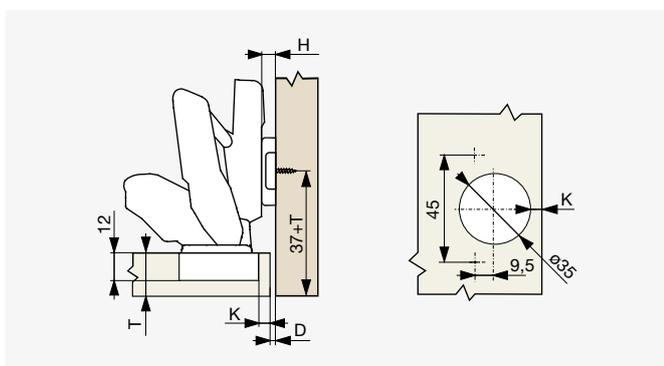

Pločica H2

Pločica H4

K [mm]

D [mm]

D [mm]

4

1

3

5

0

2

6

-1

1

Podješavanje ± 3 mm.

## ⊕ Riex NC70 Spojnica 30°



Tip

Kod

Soft-Close

F000034

Bez opruge [Push-to-Open]

F000035

Preporučene montažne pločice:

- F000043 H0 navrtanje sa CAM
- F000046 H0 navrtanje

Druge montažne pločice i poklopci NC70 / NC50 na strani 2.15.

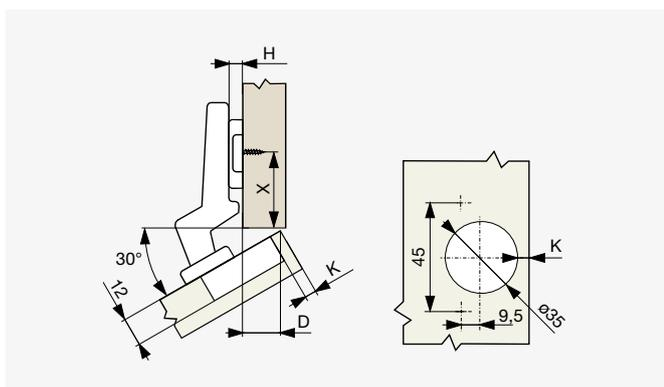

Pločica H0

Pločica H2

Pločica H4

K [mm]

X [mm]

D [mm]

D [mm]

D [mm]

4

37

3

1

-1

5

36

4

2

0

6

35

5

3

1

7

34

6

4

2

Podješavanje ± 3 mm.

### ⊕ Riex NC70 Spojnica 45°

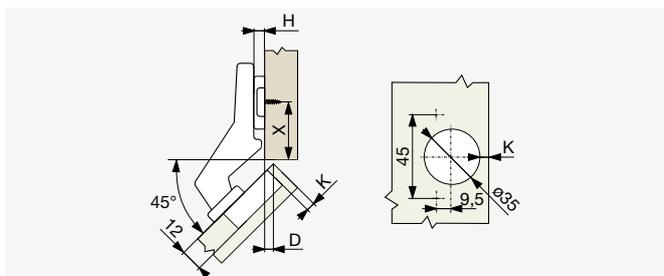

Tip	Kod
Soft-Close	F000036
Bez opruge [Push-to-Open]	F000037

**Preporučene montažne pločice:**

- F000043 H0 navrtanje sa CAM
- F000046 H0 navrtanje

Druge montažne pločice i poklopci NC70 / NC50 na strani 2.15.

K [mm]	X [mm]	Pločica H0	Pločica H2	Pločica H4
		D [mm]	D [mm]	D [mm]
4	37	3	1	-1
5	36	4	2	0
6	35	5	3	1

Podješavanje ± 3 mm.

### ⊕ Riex NC70 Spojnica 90°

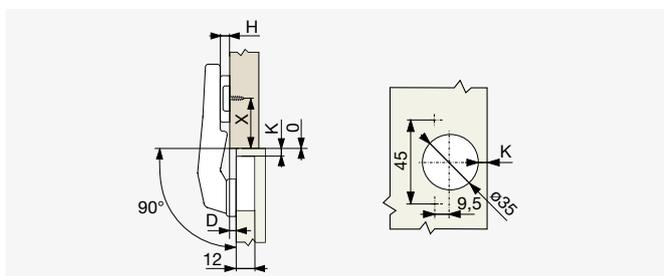

Tip	Kod
Soft-Close	F000038
Bez opruge [Push-to-Open]	F000039

**Preporučene montažne pločice:**

- F000044 H2 navrtanje sa CAM
- F000047 H2 navrtanje

Druge montažne pločice i poklopci NC70 / NC50 na strani 2.15.

K [mm]	X [mm]	Pločica H0	Pločica H2	Pločica H4
		D [mm]	D [mm]	D [mm]
4	20	3	1	-1
5	19	3	1	-1

Podješavanje ± 3 mm.

### ⊕ Riex NC70 Spojnica 135°

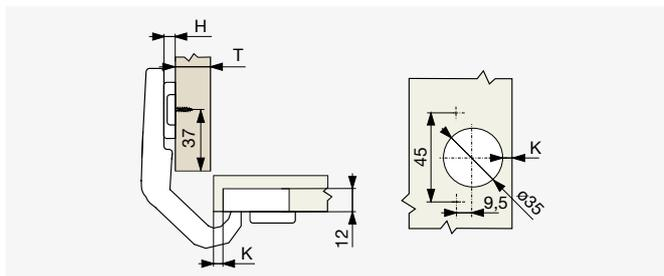

Tip	Kod
Bez Soft-Close-a	F000040

Spojnica je dizajnirana za kutne ormare sa preklopnim vratima.

**Preporučene montažne pločice:**

- F000043 H0 navrtanje sa CAM
- F000046 H0 navrtanje

Druge montažne pločice i poklopci NC70 / NC50 na strani 2.15.

T [mm]	Visina of plate
18-22	H0
16	H2



## ⊕ Riex NC70 Ravna spojnica za staklena vrata

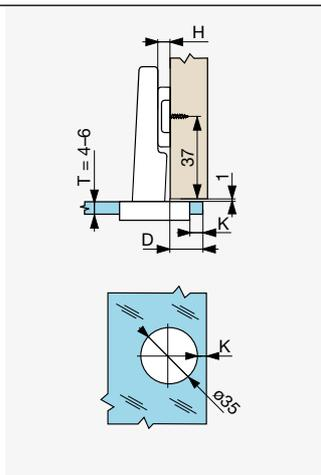

Tip	Kod
Soft-Close	F000143

### Preporučene montažne pločice:

- F000043 H0 navrtanje sa CAM
- F000046 H0 navrtanje

Druge montažne pločice i poklopci NC70 / NC50 na strani 2.15.

K [mm]	Pločica H0	Pločica H2	Pločica H4
	D [mm]	D [mm]	D [mm]
4	15	13	11
5	16	14	12
6	17	15	13

Podješavanje ± 3 mm.

## ⊕ Riex NC70 Kriva spojnica za staklena vrata

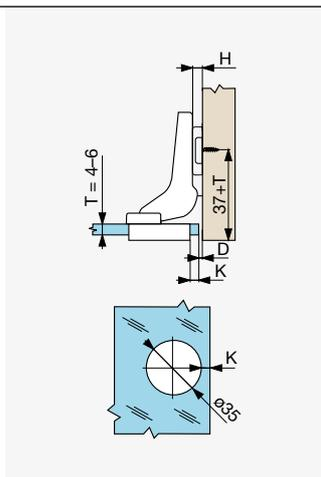

Tip	Kod
Soft-Close	F000145

### Preporučene montažne pločice:

- F000043 H0 navrtanje sa CAM
- F000046 H0 navrtanje

Druge montažne pločice i poklopci NC70 / NC50 na strani 2.15.

K [mm]	Pločica H0	Pločica H2	Pločica H4
	D [mm]	D [mm]	D [mm]
4	3	5	7
5	2	4	6
6	1	3	5

Podješavanje ± 3 mm.

## ⊕ Riex NC70 Potpuno preklopna spojnica za tanak okvir od aluminija

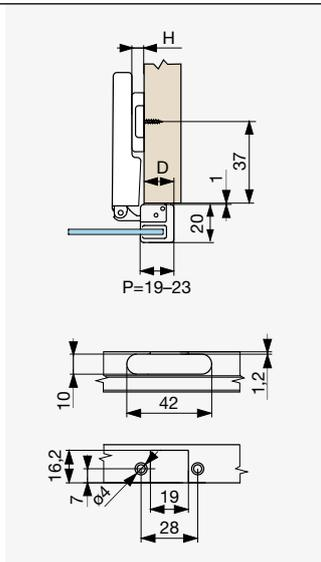

Tip	Kod
Soft-Close	F003334

### Preporučene montažne pločice:

- F000043 H0 navrtanje sa CAM
- F000046 H0 navrtanje

Druge montažne pločice i poklopci NC70 / NC50 na strani 2.15.

Spojnice uključuju vijke za montažu spojnice na okvir.

P [mm]	Pločica H0	Pločica H2	Pločica H4
	D [mm]	D [mm]	D [mm]
19	17	15	13
20	18	16	14
21	19	17	15
22	20	18	16
23	21	19	17

Podješavanje ± 3 mm.

## ⊕ Riex NC50 Ravna spojnica



Tip	Kod
Soft-Close	F000014
Bez Soft-Close-a	F000019

ⓘ s. 2.13

Preporučene montažne pločice:

- F000043 H0 navrtanje sa CAM
- F000046 H0 navrtanje

Druge montažne pločice i poklopci NC70 / NC50 na strani 2.15.

## ⊕ Riex NC50 Potpuno preklopna spojnica + Pločica H0



Tip	Kod
Soft-Close	F000003

ⓘ s. 2.13

Sadrži:

- 1 komad spojnice
- 1 komade montažne pločice H0 navrtanje

## ⊕ Riex NC50 Potpuno preklopna spojnica sa Euro vijcima



Tip	Kod
Soft-Close	F000005

ⓘ s. 2.13

Preporučene montažne pločice:

- F000043 H0 navrtanje sa CAM
- F000049 H0 sa euro vijcima

Druge montažne pločice i poklopci NC70 / NC50 na strani 2.15.

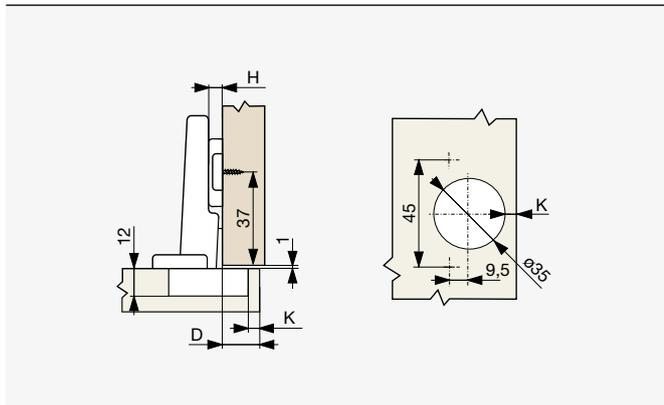

## ⓘ Riex NC50 Potpuno preklapanje

- Crtež i tablica važe za proizvod na strani 2.13

K [mm]	Pločica H0	Pločica H2	Pločica H4
	D [mm]	D [mm]	D [mm]
4	15	13	11
5	16	14	12
6	17	15	13

Podješavanje ± 3 mm.

## ⊕ Riex NC50 Polu kriva spojnica



Tip	Kod
Soft-Close	F000021
Bez Soft-Close-a	F000022

### Preporučene montažne pločice:

- F000043 H0 navrtanje sa CAM
- F000046 H0 navrtanje

Druge montažne pločice i poklopci NC70 / NC50 na strani 2.15.

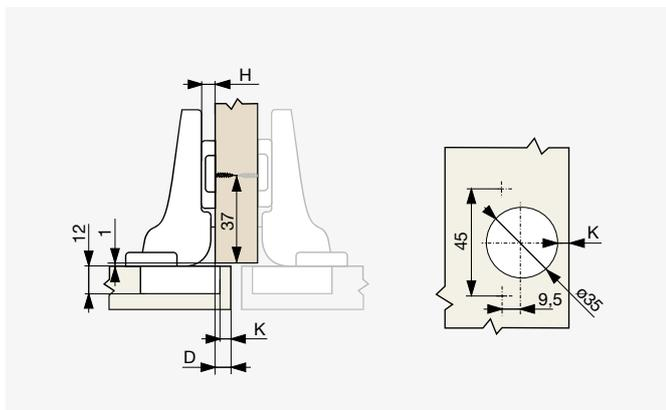

K [mm]	Pločica H0	Pločica H2	Pločica H4
	D [mm]	D [mm]	D [mm]
4	6	4	2
5	7	5	3
6	8	6	4

Podješavanje  $\pm 3$  mm.

## ⊕ Riex NC50 Spojnica kriva



Tip	Kod
Soft-Close	F000024
Bez Soft-Close-a	F000025

### Preporučene montažne pločice:

- F000043 H0 navrtanje sa CAM
- F000046 H0 navrtanje

Druge montažne pločice i poklopci NC70 / NC50 na strani 2.15.

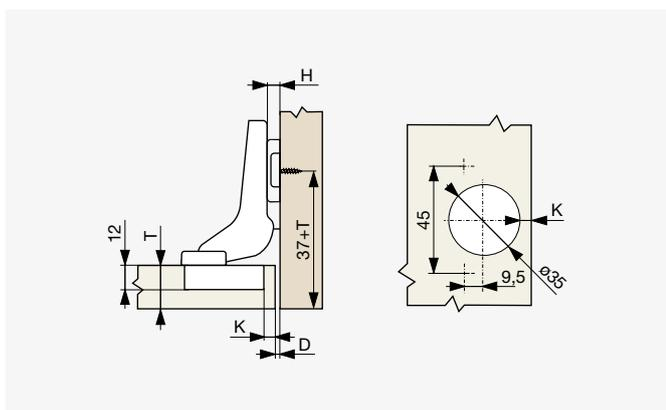

K [mm]	Pločica H0	Pločica H2	Pločica H4
	D [mm]	D [mm]	D [mm]
4	3	5	7
5	2	4	6
6	1	3	5

Podješavanje  $\pm 3$  mm.

# Riex NC70 / NC50 Montažne pločice i dodaci

## ☛ Pločica koja se pričvršćuje vijcima s CAM-om

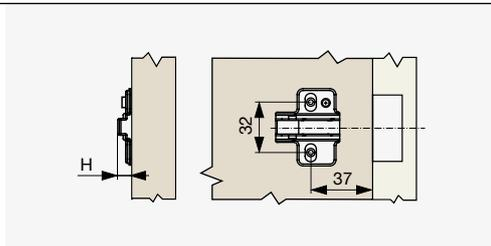

Tip	Kod
H0	F000043
H2	F000044
H4	F000045

## ☛ Pločica koja se pričvršćuje vijcima

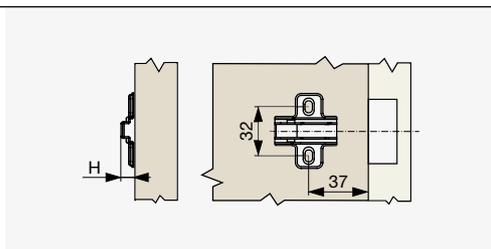

Tip	Kod
H0	F000046
H2	F000047
H4	F000048

## ☛ Pločica s Euro vijcima

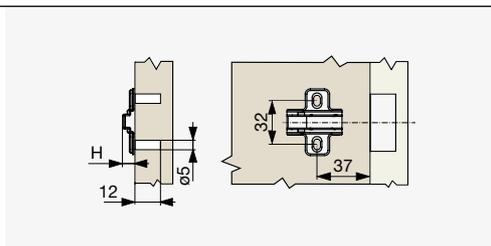

Tip	Kod
H0	F000049

## ☛ Pločica s tiplama ø5 mm i s CAM-om

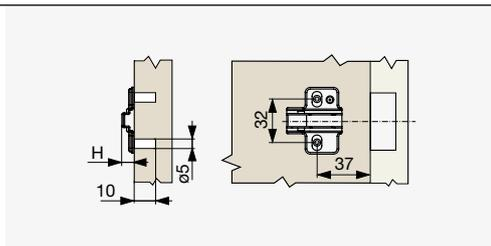

Tip	Kod
H0	F000050

### ⊕ Pločica s tiplama $\varnothing 5$ mm

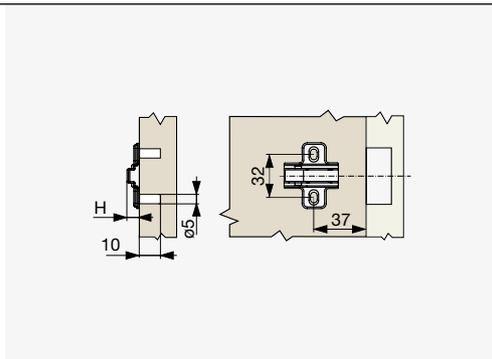

Tip	Kod
H0	F000051

### ⊕ Ukras za spojnice



Tip	Kod
Maskica	F000053
Ručica	F000054

### ⊕ Graničnik kuta otvaranja

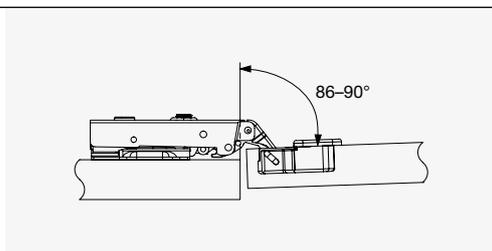

Tip	Kod
Smanjuje na 90°	F003063

01  
02  
03  
04  
05  
06  
07  
08  
09  
10  
11  
12  
13  
14  
15  
16  
17  
18

# Riex NC40 spojnica

## ⊕ Riex NC40 Potpuno preklopna spojnica



Tip	Kod
Soft-Close	F000058
Bez Soft-Close-a	F000063

ⓘ s. 2.18

Preporučene montažne pločice:

- F000093 H0 navrtanje sa CAM
- F000096 H0 navrtanje

Druge montažne pločice i poklopci NC40 na strani 2.24

## ⊕ Riex NC40 Potpuno preklopna spojnica bez CAM



Tip	Kod
Bez Soft-Close-a	F000071

ⓘ s. 2.18

Preporučene montažne pločice:

- F000096 H0 navrtanje

Druge montažne pločice i poklopci NC40 na strani 2.24

## ⊕ Riex NC40 Potpuno preklopna spojnica sa Euro vijcima



Tip	Kod
Soft-Close	F003496

ⓘ s. 2.18

Preporučene montažne pločice:

- F000093 H0 navrtanje sa CAM
- F000099 H0 sa euro vijcima

Druge montažne pločice i poklopci NC40 na strani 2.24

## ⊕ Riex NC40 Potpuno preklopna spojnica + Pločica H0 sa CAM



Tip	Kod
Soft-Close	F000060

ⓘ s. 2.18

**Sadrži:**

- 1 komad spojnice
- 1 komad montažne pločice H0 navrtanje sa CAM

## ⊕ Riex NC40 Potpuno preklopna spojnica + Pločica H0



Tip	Kod
Soft-Close	F000061

ⓘ s. 2.18

**Sadrži:**

- 1 komad spojnice
- 1 komade montažne pločice H0 navrtanje

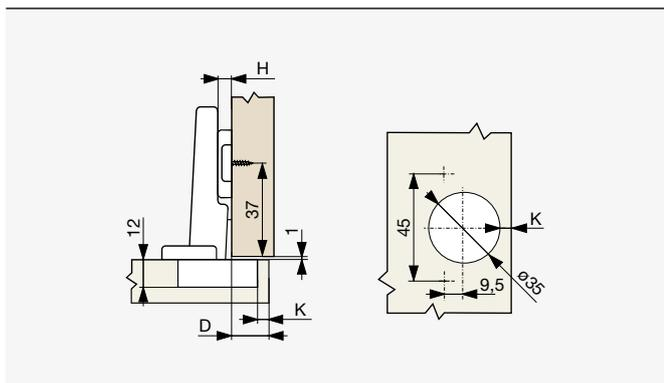

### ⓘ Riex NC40 Potpuno preklopna spojnica

- Crtež i tablica važe za proizvod na stranama 2.17 i 2.18

K [mm]	Pločica H0	Pločica H2	Pločica H4
	D [mm]	D [mm]	D [mm]
4	14	12	10
5	15	13	11
6	16	14	12

Podješavanje ± 4 mm.

### ⊕ Riex NC40 Spojnica, djelomično preklapanje



Tip	Kod
Soft-Close	F000065
Bez Soft-Close-a	F000066

**Preporučene montažne pločice:**

- F000093 H0 navrtanje sa CAM
- F000096 H0 navrtanje

Druge montažne pločice i poklopci NC40 na strani 2.24

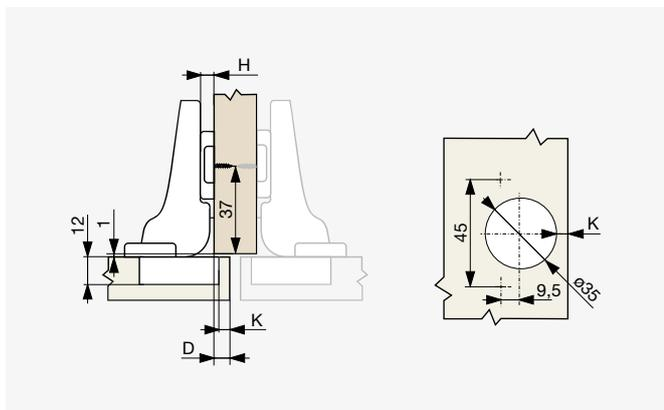

K [mm]	Pločica H0	Pločica H2	Pločica H4
	D [mm]	D [mm]	D [mm]
4	4	2	0
5	5	3	1
6	6	4	2

Podješavanje ± 4 mm.

### ⊕ Riex NC40 Umetnuta spojnica



Tip	Kod
Soft-Close	F000068
Bez Soft-Close-a	F000069

**Preporučene montažne pločice:**

- F000093 H0 navrtanje sa CAM
- F000096 H0 navrtanje

Druge montažne pločice i poklopci NC40 na strani 2.24

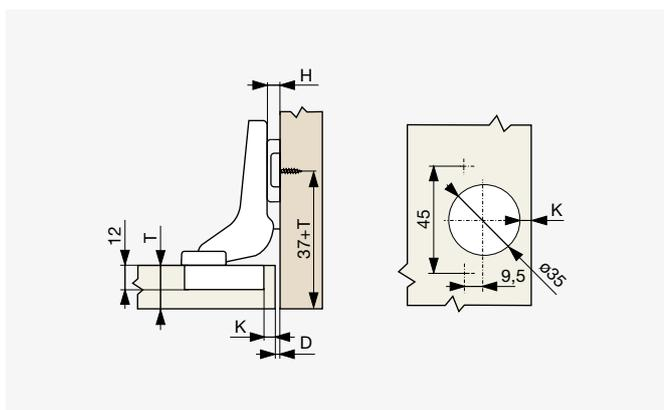

K [mm]	Pločica H0	Pločica H2	Pločica H4
	D [mm]	D [mm]	D [mm]
4	4	6	8
5	3	5	7
6	2	4	6

Podješavanje ± 4 mm.



## ⊕ Riex NC40 Spojnica 155°, potpuno preklapanje s nultom izbočinom



Tip

Kod

Soft-Close

F000074

Funkcija nulte izbočine čini ove spojnice prikladnima za korištenje s unutarnjim ladicama i košarama na izvlačenje.

Preporučene montažne pločice:

- F000093 H0 navrtanje sa CAM
- F000096 H0 navrtanje

Druge montažne pločice i poklopci NC40 na strani 2.24

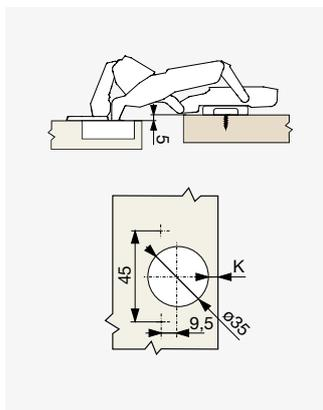
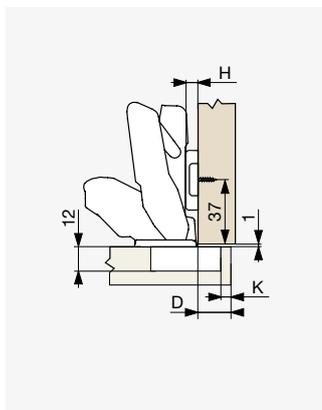

K [mm]	Pločica H0	Pločica H2	Pločica H4
	D [mm]	D [mm]	D [mm]
4	15	13	11
5	16	14	12
6	17	15	13

Podješavanje ± 3 mm.

## ⊕ Riex NC40 Spojnica 155°, djelomično preklapanje



Tip

Kod

Soft-Close

F000077

Preporučene montažne pločice:

- F000093 H0 navrtanje sa CAM
- F000096 H0 navrtanje

Druge montažne pločice i poklopci NC40 na strani 2.24

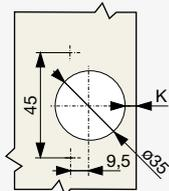
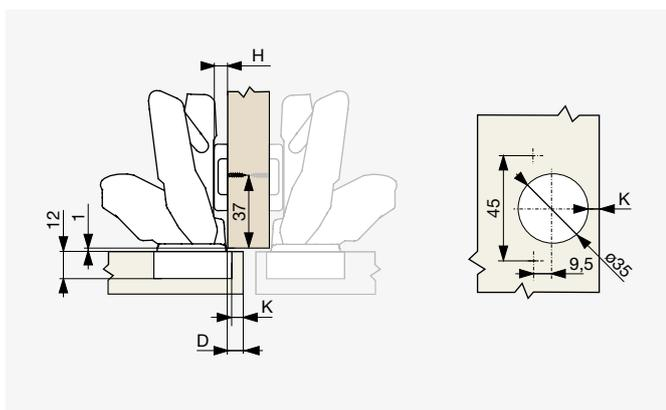

K [mm]	Pločica H0	Pločica H2	Pločica H4
	D [mm]	D [mm]	D [mm]
4	6	4	2
5	7	5	3
6	8	6	4

Podješavanje ± 3 mm.

### ⊕ Riex NC40 Umetnuta spojnica 155°



Tip	Kod
Soft-Close	F000079

**Preporučene montažne pločice:**

- F000093 H0 navrtanje sa CAM
- F000096 H0 navrtanje

Druge montažne pločice i poklopci NC40 na strani 2.24

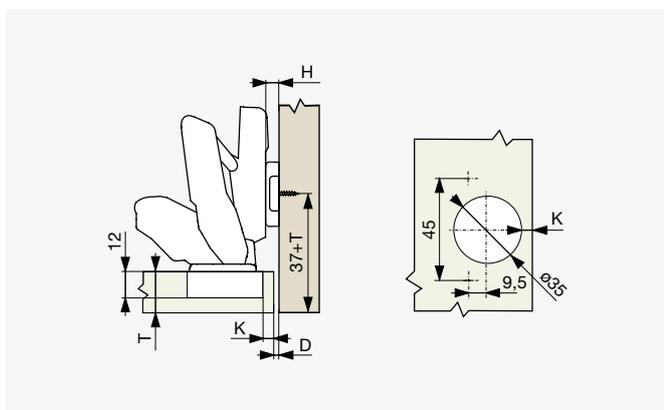

K [mm]	Pločica H0	Pločica H2	Pločica H4
	D [mm]	D [mm]	D [mm]
4	0	2	4
5	-1	1	3
6	-2	0	2

Podješavanje ± 3 mm.

### ⊕ Riex NC40 Spojnica 30°



Tip	Kod
Soft-Close	F000081
Bez Soft-Close-a	F000082

**Preporučene montažne pločice:**

- F000093 H0 navrtanje sa CAM
- F000096 H0 navrtanje

Druge montažne pločice i poklopci NC40 na strani 2.24

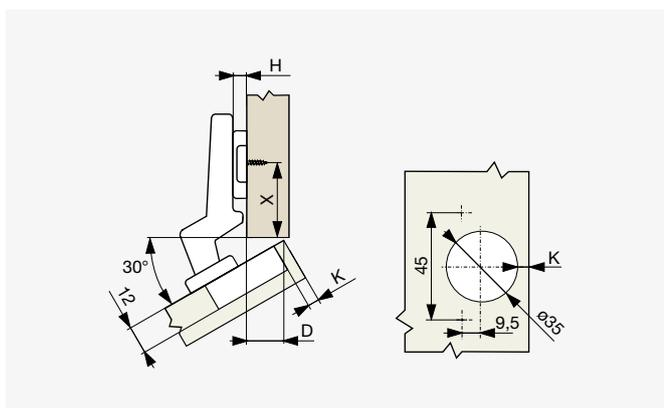

K [mm]	X [mm]	Pločica H0	Pločica H2	Pločica H4
		D [mm]	D [mm]	D [mm]
5	36	3	1	-1
6	35	4	2	0
7	34	5	3	1

Podješavanje ± 3 mm.

## ⊕ Riex NC40 Spojnica 45°



Tip

Kod

Soft-Close

F000084

Bez Soft-Close-a

F000085

Preporučene montažne pločice:

- F000093 H0 navrtanje sa CAM
- F000096 H0 navrtanje

Druge montažne pločice i poklopci NC40 na strani 2.24

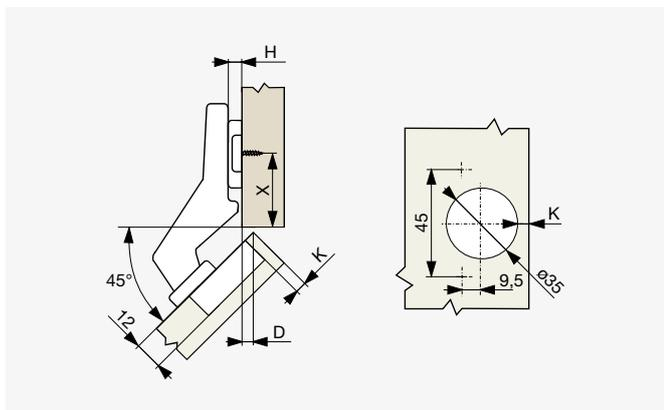

K [mm]	X [mm]	Pločica H0	Pločica H2	Pločica H4
		D [mm]	D [mm]	D [mm]
4	37	4	2	0
5	36	5	3	1
6	35	6	4	2
7	37	7	5	3

Podješavanje ± 3 mm.

## ⊕ Riex NC40 Spojnica 90°



Tip

Kod

Soft-Close

F000087

Bez Soft-Close-a

F000088

Preporučene montažne pločice:

- F000094 H2 navrtanje sa CAM
- F000097 H2 navrtanje

Druge montažne pločice i poklopci NC40 na strani 2.24

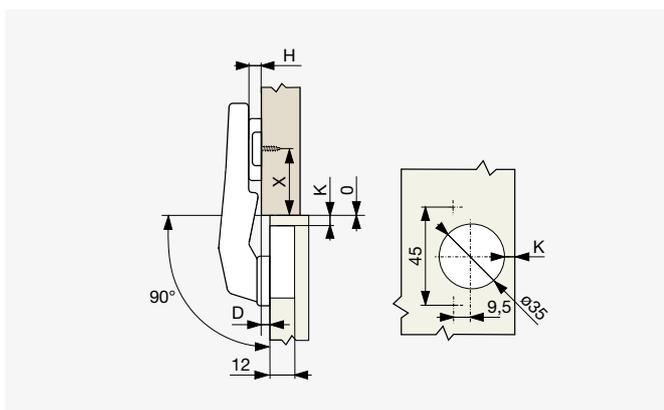

K [mm]	X [mm]	Pločica H0	Pločica H2	Pločica H4
		D [mm]	D [mm]	D [mm]
4	20	3	1	-1
5	19	3	1	-1

Podješavanje ± 3 mm.

### ⊕ Riex NC40 Spojnica 135°



Tip	Kod
Bez Soft-Close-a	F000090

Spojnica je dizajnirana za kutne ormare sa preklopnim vratima.

Preporučene montažne pločice:

- F000093 H0 navrtanje sa CAM
- F000096 H0 navrtanje

Druge montažne pločice i poklopci NC40 na strani 2.24

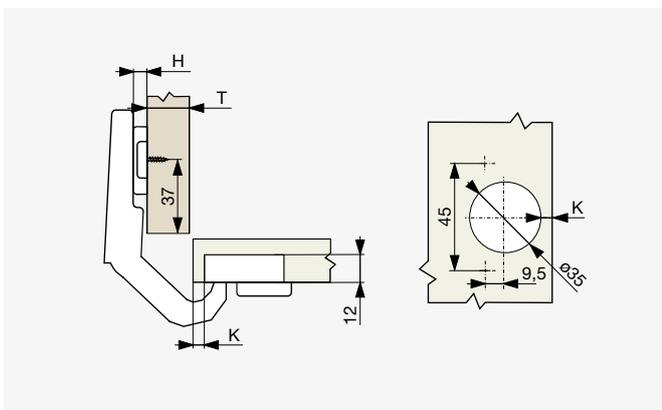

T [mm]	Visina of plate
18-22	H0
16	H2

# Riex NC40

## Montažne pločice i dodaci

### ☛ Pločica koja se pričvršćuje vijcima s CAM-om

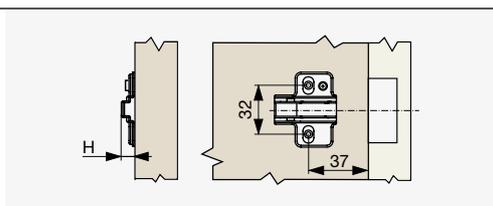

Tip	Kod
H0	F000093
H2	F000094
H4	F000095

### ☛ Pločica koja se pričvršćuje vijcima

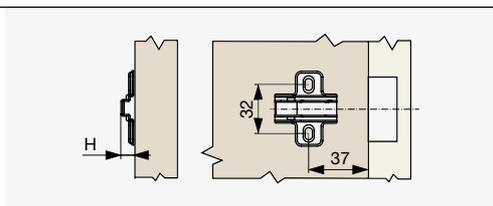

Tip	Kod
H0	F000096
H2	F000097
H4	F000098

### ☛ Pločica s Euro vijcima

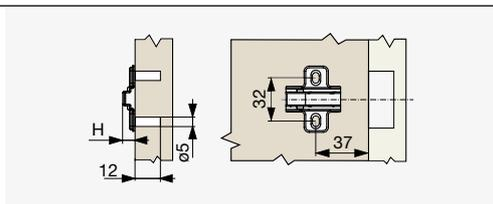

Tip	Kod
H0	F000099

### ☛ Pločica koja se pričvršćuje vijcima [4 rupe]

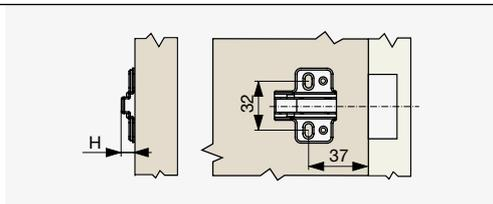

Tip	Kod
H0	F000100

### ☛ Ukrasi za spojnice



Tip	Kod
Maskica	F000102
Ručica – potpuno preklopne spojnice	F000103
Ručica – djelomično preklopne spojnice i umetnute spojnice	F000104

# Riex NC20 Spojnica

## ⊕ Riex NC20 Potpuno preklopna spojnica + pločica H0



Tip	Kod
Soft-Close	F000123

**Sadrži:**

- 1 komad spojnice
- 1 komad montažne pločice H0 navrtanje

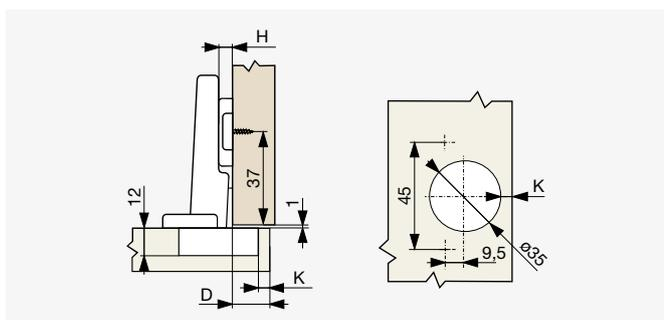

K [mm]	Pločica H0
	D [mm]
4	16
5	17
6	18

Podješavanje ± 2 mm.

## ⊕ Riex NC20 Potpuno preklopna spojnica + pločica H0 s Euro vijcima



Tip	Kod
Soft-Close	F000124

**Sadrži:**

- 1 komad spojnice
- 1 komad montažne pločice H0 s euro vijcima  
[prethodno izbušene rupe ø5 × 12 mm]

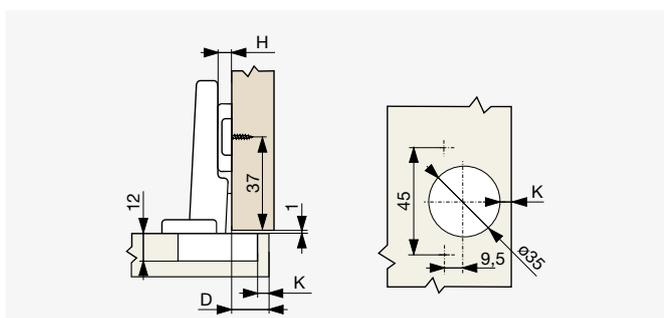

K [mm]	Pločica H0
	D [mm]
4	16
5	17
6	18

Podješavanje ± 2 mm.

## ⊕ Riex NC20 Djelomično preklopna spojnica + pločica H0



Tip	Kod
Soft-Close	F000125

**Sadrži:**

- 1 komad spojnice
- 1 komad montažne pločice H0 navrtanje

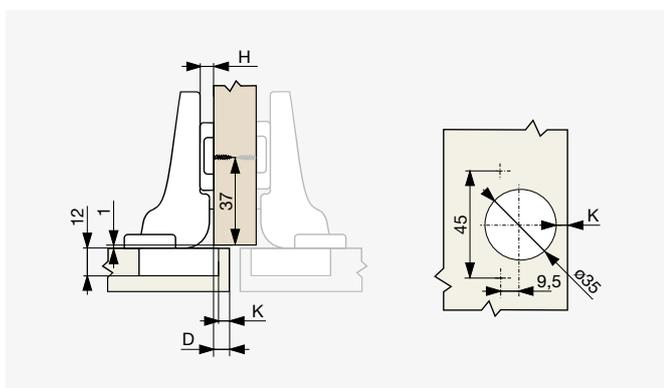

K [mm]	Pločica H0
	D [mm]
4	7
5	8
6	9

 Podješavanje  $\pm 2$  mm.

## ⊕ Riex NC20 Umetnuta spojnica + pločica H0



Tip	Kod
Soft-Close	F000126

**Sadrži:**

- 1 komad spojnice
- 1 komad montažne pločice H0 navrtanje

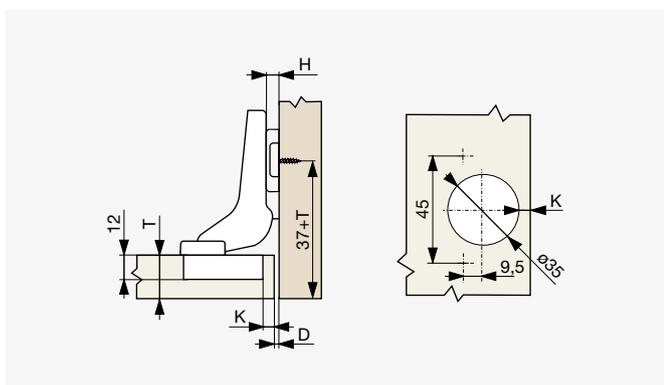

K [mm]	Pločica H0
	D [mm]
4	2
5	1
6	0

 Podješavanje  $\pm 2$  mm.

 01  
02  
03  
04  
05  
06  
07  
08  
09  
10  
11  
12  
13  
14  
15  
16  
17  
18

# Riex NS40 Klizna spojnica

## ⊕ Riex NS40 Potpuno preklopna spojnica



Tip	Kod
Bez Soft-Close-a	F000107

### Preporučene montažne pločice:

- F000115 H0 navrtanje
- F000116 H0 sa euro vijcima

Druge montažne pločice i poklopci [maskice] NS40 on p. 2.29.

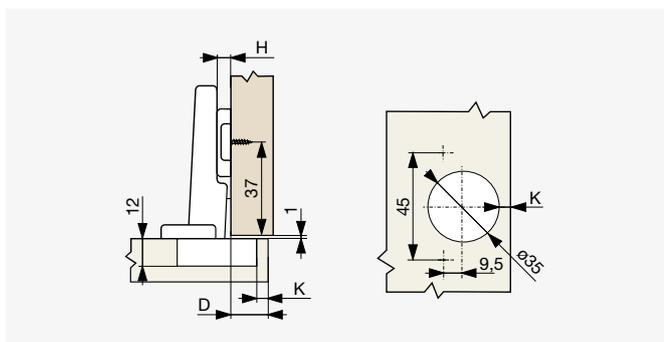

K [mm]	Pločica H0	Pločica H2	Pločica H4
	D [mm]	D [mm]	D [mm]
4	13	11	9
5	14	12	10
6	15	13	11

Podješavanje ± 4 mm.

## ⊕ Riex NS40 Potpuno preklopna spojnica s euro vijcima



Tip	Kod
Bez Soft-Close-a	F000108

### Preporučene montažne pločice:

- F000115 H0 navrtanje
- F000116 H0 sa euro vijcima

Druge montažne pločice i poklopci [maskice] NS40 on p. 2.29.

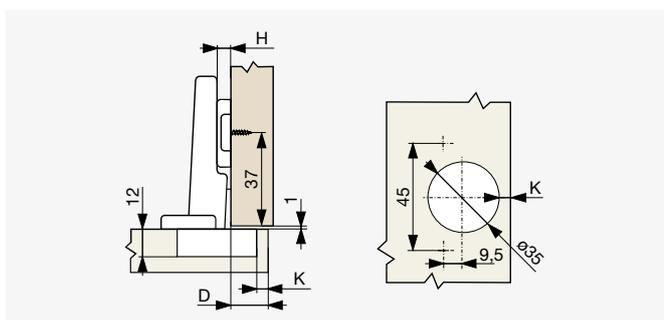

K [mm]	Pločica H0	Pločica H2	Pločica H4
	D [mm]	D [mm]	D [mm]
4	13	11	9
5	14	12	10
6	15	13	11

Podješavanje ± 4 mm.



## ⊕ Riex NS40 Spojnica, djelomično preklapanje



Tip

Kod

Bez Soft-Close-a

F000111

Preporučene montažne pločice:

- F000115 H0 navrtanje
- F000116 H0 sa euro vijcima

Druge montažne pločice i poklopci [maskice] NS40 on p. 2.29.

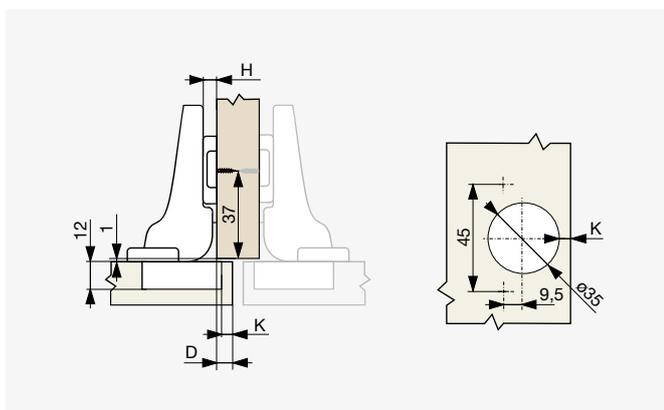

K [mm]	Pločica H0	Pločica H2	Pločica H4
	D [mm]	D [mm]	D [mm]
4	4	2	0
5	5	3	1
6	6	4	2

Podješavanje ± 4 mm.

## ⊕ Riex NS40 Umetnuta spojnica



Tip

Kod

Bez Soft-Close-a

F000112

Preporučene montažne pločice:

- F000115 H0 navrtanje
- F000116 H0 sa euro vijcima

Druge montažne pločice i poklopci [maskice] NS40 on p. 2.29.

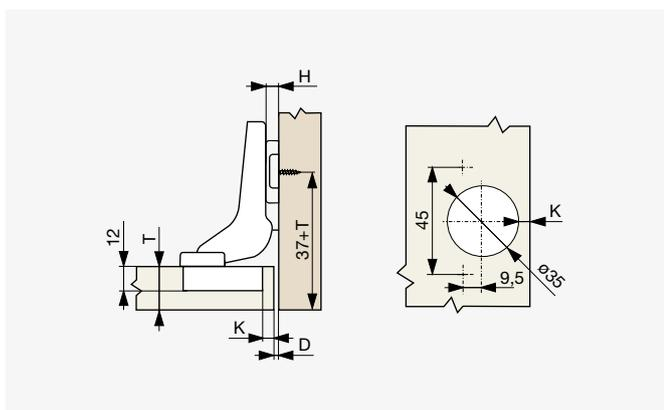

K [mm]	Pločica H0	Pločica H2	Pločica H4
	D [mm]	D [mm]	D [mm]
4	4	6	8
5	3	5	7
6	2	4	6

Podješavanje ± 4 mm.

# Riex NS40 Montažne pločice

## ⊖ Pločica za pričvrščivanje vijcima

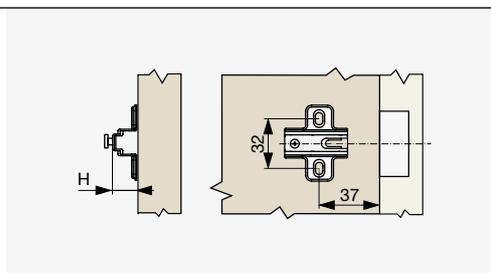

Tip	Kod
H0	F000115
H2	F000117
H4	F000118

## ⊖ Pločica s euro vijcima

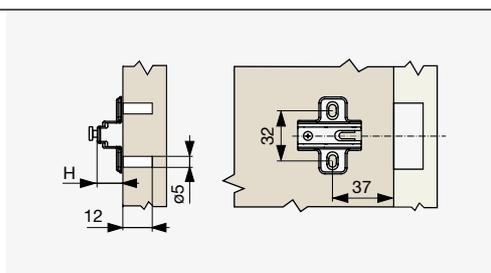

Tip	Kod
H0	F000116

# Riex NS20 Klizna spojnica

## ⊕ Riex NS20 Potpuno preklopna spojnica + pločica H0 **ECONOMY**

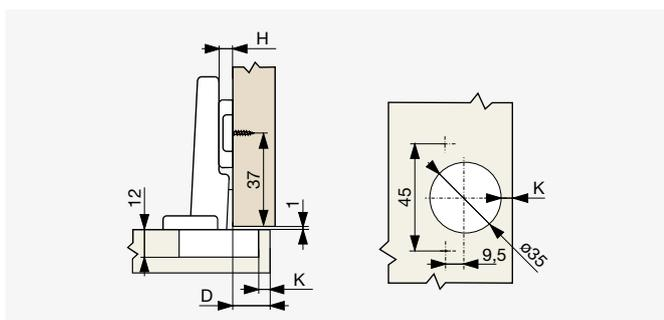

Tip	Kod
Bez Soft-Close-a	F000127

### Sadrži:

- 1 komad spojnice
- 1 komad montažne pločice H0 navrtanje

K [mm]	Pločica H0	
	D [mm]	
4	16	
5	17	
6	18	

Podješavanje ± 2 mm.

## ⊕ Riex NS20 Potpuno preklopna spojnica + pločica H0 s euro vijcima **ECONOMY**

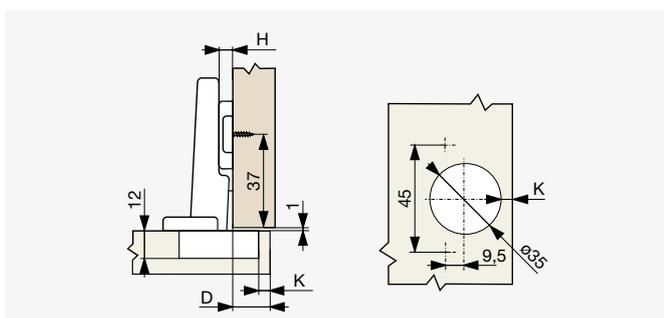

Tip	Kod
Bez Soft-Close-a	F000128

### Sadrži:

- 1 komad spojnice
- 1 komad montažne pločice H0 s euro vijcima

K [mm]	Pločica H0	
	D [mm]	
4	16	
5	17	
6	18	

Podješavanje ± 2 mm.

**⊕ Riex NS20 Spojnica, djelomično preklapanje  
+ pločica H0 **ECONOMY****



Tip	Kod
Bez Soft-Close-a	F000130

- Sadrži:**
- 1 komad spojnice
  - 1 komad montažne pločice H0 navrtanje

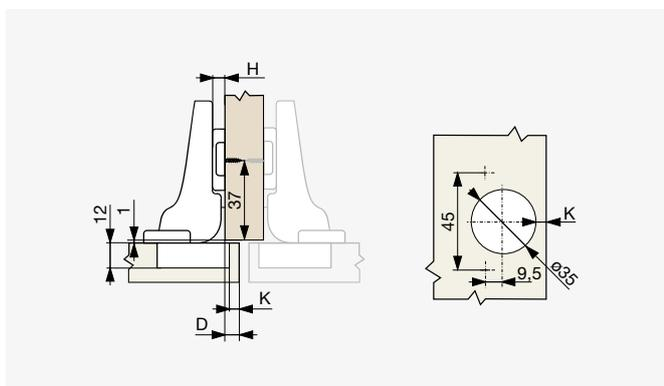

K [mm]	Pločica H0	
	D [mm]	
4	7	
5	8	
6	9	

Podješavanje  $\pm 2$  mm.

**⊕ Riex NS20 Umetnuta spojnica  
+ pločica H0 **ECONOMY****



Tip	Kod
Bez Soft-Close-a	F000131

- Sadrži:**
- 1 komad spojnice
  - 1 komad montažne pločice H0 navrtanje

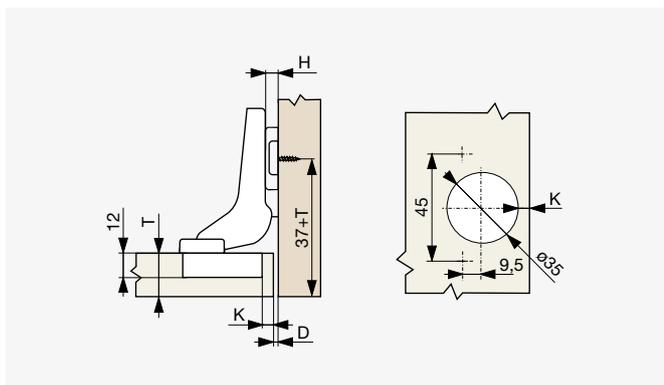

K [mm]	Pločica H0	
	D [mm]	
4	2	
5	1	
7	0	

Podješavanje  $\pm 2$  mm.

# Riex NS10

## Klizna spojnica

⊕ Riex NS10 Potpuno preklopna spojnica  
+ pločica H0 **ECONOMY**

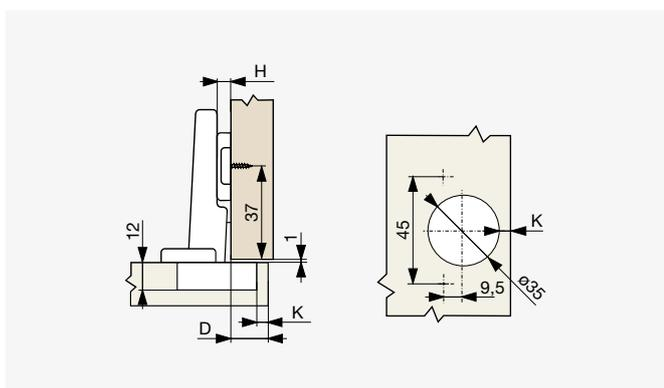

Tip	Kod
Bez Soft-Close-a	F000129

K [mm]	Pločica H0	
	D [mm]	
4	16	
5	17	
6	18	

Podješavanje ± 2 mm.

# Riex NS30

## Mini klizne spojnice

### ⊖ Riex NS30 Spojnica, $\varnothing 26$ mm ravna + pločica H0



Tip	Kod
Bez Soft-Close-a	F000136

**Sadrži:**

- 1 komad spojnice
- 1 komad montažne pločice H0 navrtanje

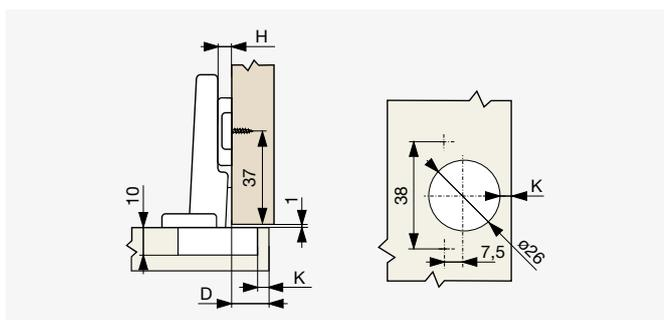

K [mm]	Pločica H0	
	D [mm]	
3	14	
4	15	
5	16	

 Podješavanje  $\pm 1,5$  mm.

### ⊖ Riex NS30 Spojnica, $\varnothing 26$ mm maskica, potpuno preklapanje + pločica H0 s euro vijcima



Tip	Kod
Bez Soft-Close-a	F000137

**Sadrži:**

- 1 komad spojnice
- 1 komad montažne pločice H0 s euro vijcima [prethodno izbušene rupe  $\varnothing 5 \times 12$  mm]

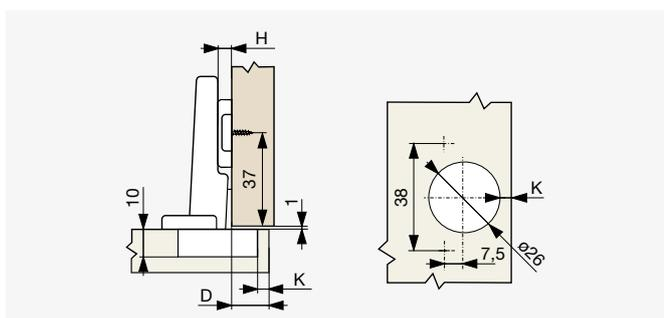

K [mm]	Pločica H0	
	D [mm]	
3	14	
4	15	
5	16	

 Podješavanje  $\pm 1,5$  mm.

## ⊕ Riex NS30 Spojnica, ø26 mm polukriva + pločica H0



Tip

Kod

Bez Soft-Close-a

F000138

## Sadrží:

- 1 komad spojnice
- 1 komad montažne pločice H0 navrtanje

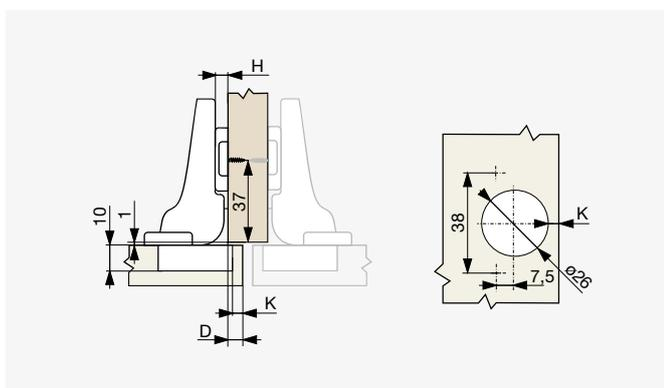

K [mm]

Pločica H0

D [mm]

3

6

4

7

5

8

Podješavanje ± 1,5 mm.

## ⊕ Riex NS30 Spojnica, ø26 mm kriva + pločica H0



Tip

Kod

Bez Soft-Close-a

F000139

## Sadrží:

- 1 komad spojnice
- 1 komad montažne pločice H0 navrtanje

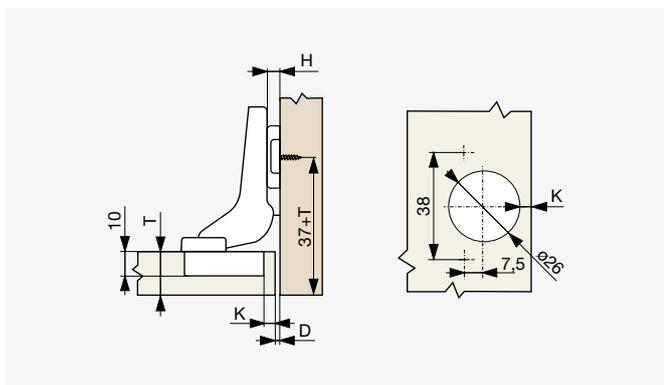

K [mm]

Pločica H0

D [mm]

3

3

4

2

5

1

Podješavanje ± 1,5 mm

# Ostale spojnice

## ● IF Kimana spojnica



● Poniklano



● Antracit

Boja	Kod
Poniklano	F002664
Antracit	F002665

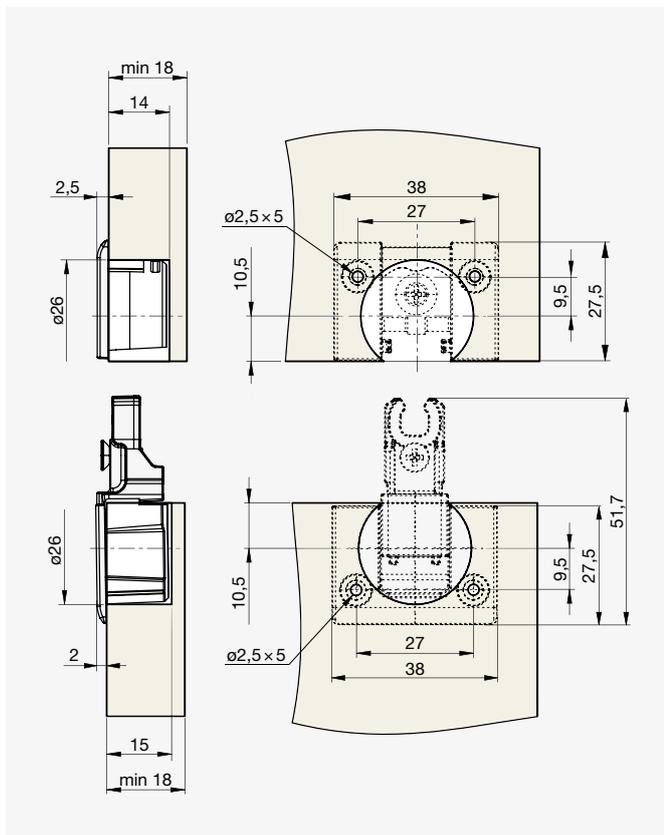

Idealan model šarki za kombiniranje s bilo kojim mehanizmom za otvaranje na spuštanje. Vidi poglavlje 3. min 18

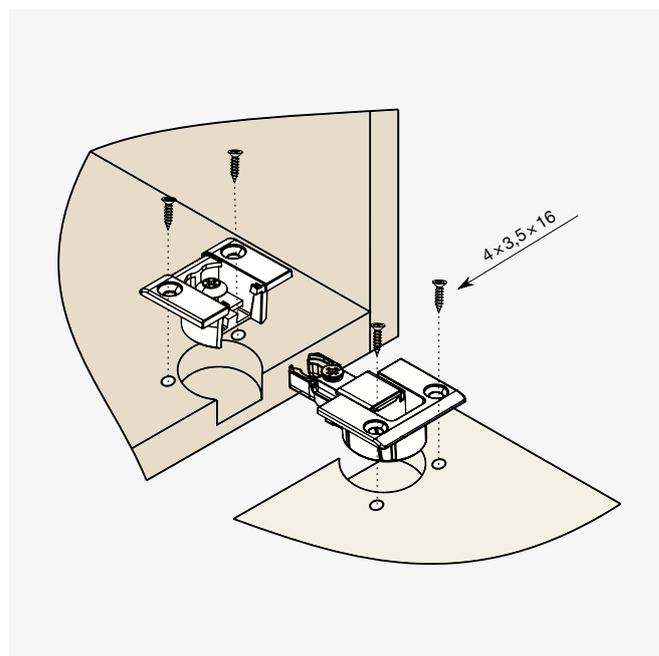



## ● IF Dodaci za Kiamana šarku

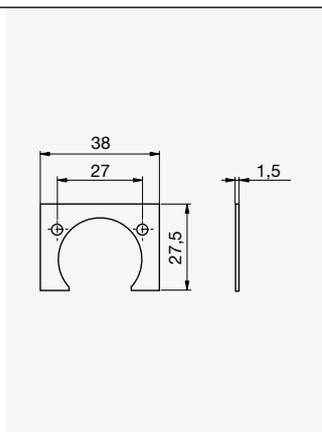

Kod

Tip

F002666

Razmaknica 1,5 mm

- Dodatna oprema ako se koriste različite debljine pločica
- Moguće korištenje više pločica za nivelaciju



### ⊖ Riex NG50 Umetnuta spojnica za staklena vrata



Tip	Kod
Krom	F002870
Crna	F002871

Sadrži:  
• Par šarki

Za staklo max. 5 mm.

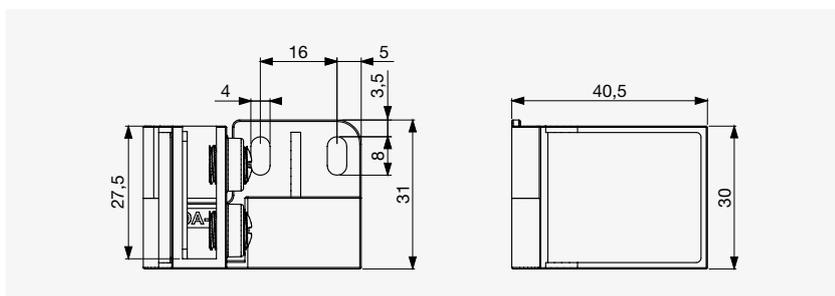

### ⊖ Riex NW20 Dvokrila klatna vrata [Saloon]

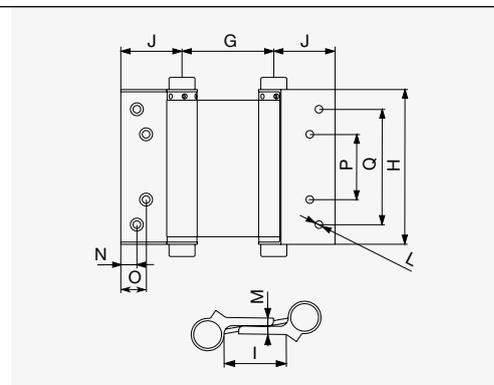

Sadrži:  
• Par šarki

Dimenzija H [mm]	Kod
75	F002141
100	F002142
125	F002143
150	F002144

Kod	H±2 [mm]	G±2 [mm]	I±2 [mm]	J±2 [mm]	L±0,5 [mm]	M±1 [mm]	N±1 [mm]	O±1 [mm]	P±2 [mm]	Q±2 [mm]
F002141	76	50	30	38	4	10	7	15	28	50
F002142	102	58	36	40	5	11	10	16	42	76
F002143	125	64	40	40	6	11	10	19	54	96
F002144	152	64	38	44	6	14	10	19	62	112

## ⊕ Riex NC05 Ravna spojnica

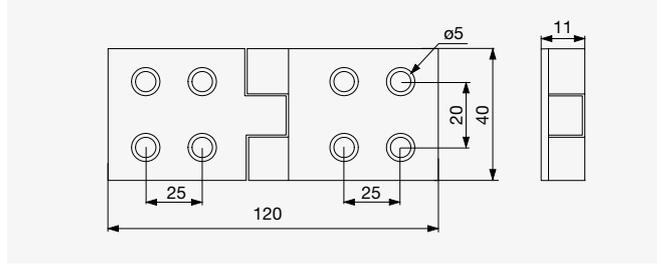

⊕ F004328

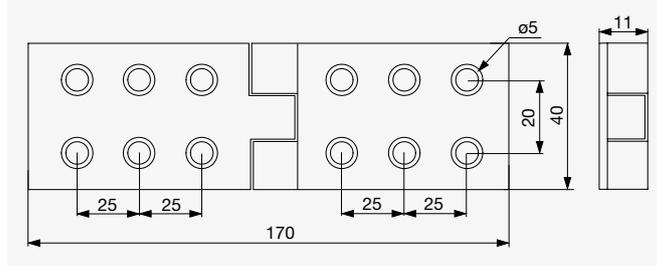

⊕ F004329

Duljina [mm]	Kod	Visina [mm]	Debljina [mm]	Boja
120	F004328	40	3	Bijeli cink
170	F004329			

## ⊕ Riex NC06 Ravna spojnica

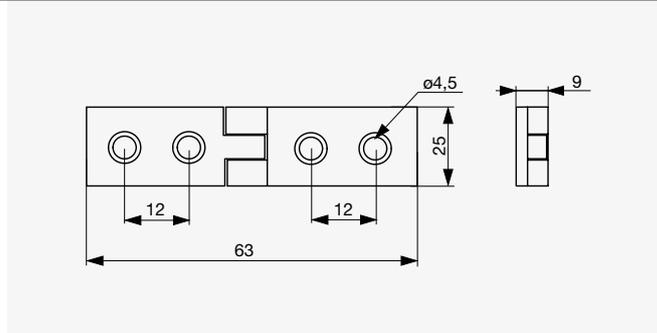

⊕ F004330

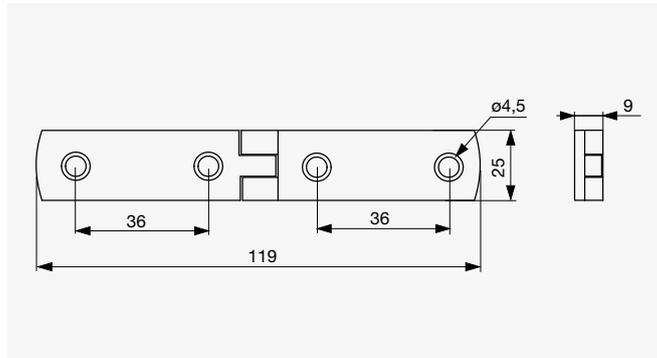

⊕ F004331

Duljina [mm]	Kod	Visina [mm]	Debljina [mm]	Boja
63	F004330	25	2	Crna
119	F004331			

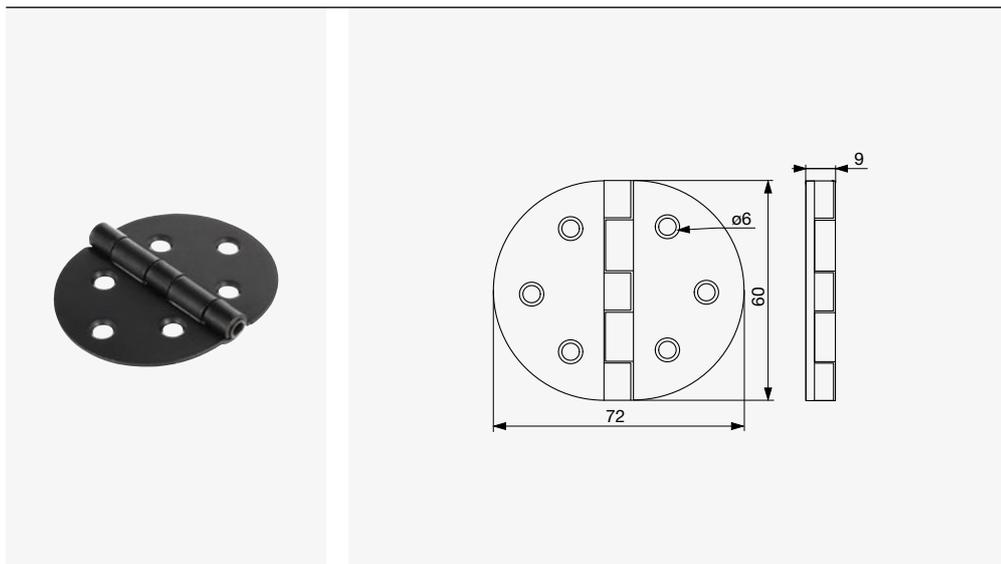
**⊕ Riex NC07 Okrugla ravna spojnica**

Duljina [mm]	Kod	Visina [mm]	Debljina [mm]	Boja
72	F004332	60	2	Crna

# Odbojnici

## ● IF Plocica sa samoljepljivim odbojnicima za vrata



D [mm]	Kod	H [mm]	Broj komada po pločici
7	F002731	1,5	50
8	F002732	2	
	F002733	1,6	
10	F002734	1,5	
	F002735	3	

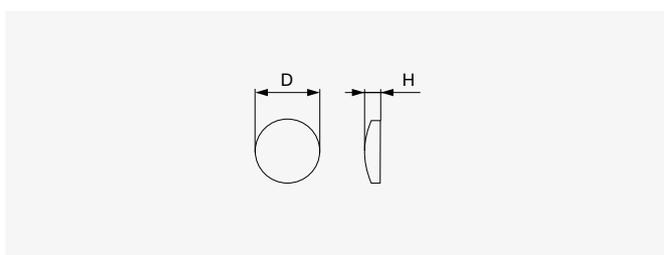

- Isporučuje se i prodaje po pločici
- Prozirna boja

## ● IF Odbojnik za vrata za bušenje $\varnothing 5$ mm

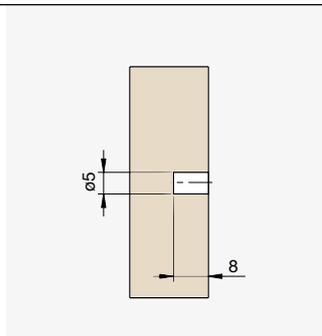
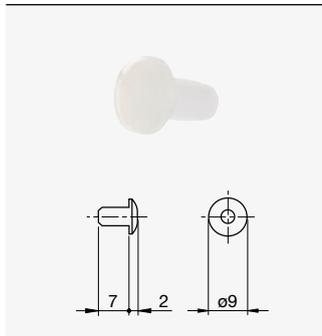

Boja	Kod
Prozirna	F002730

01  
02  
03  
04  
05  
06  
07  
08  
09  
10  
11  
12  
13  
14  
15  
16  
17  
18

# Riex Otvaranje na Push-to-Open

## ⊕ Riex NK50 Push to open za vrata



● Svijetlo siva



● Tamno siva

Boja	Kod
Svijetlo siva	F003031
Tamno siva	F003032

- U zatvorenoj poziciji moguće podješavanje +1,5 mm / +10 mm

## ⊕ Riex NK55 Push to open za vrata sa magnetom



● Svijetlo siva



● Tamno siva

Boja	Kod
Svijetlo siva	F003033
Tamno siva	F003034

- U zatvorenoj poziciji moguće podješavanje +2 mm / +10 mm

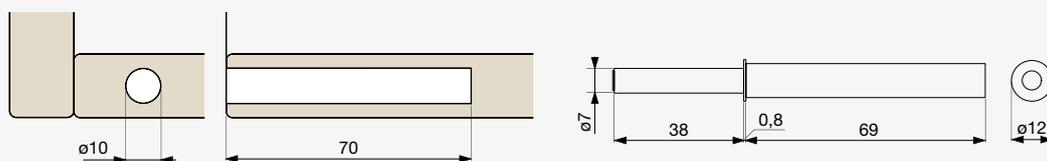

## ⊕ Riex NK50 / NK55 Adapter za vanjsku ugradnju



● Svijetlo siva



● Tamno siva

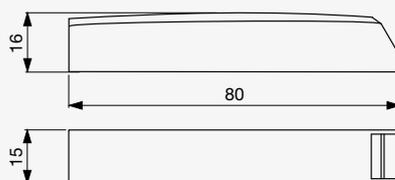
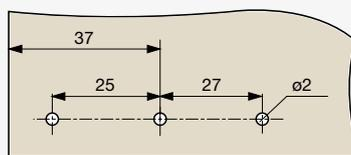

Boja

Kod

Svijetlo siva

F003035

Tamno siva

F003036

## ⊕ Riex NK35 Push to open za vrata, vanjski

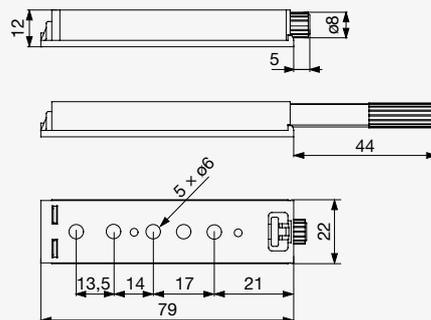

Boja

Kod

Srebrna

F003041

- U zatvorenoj poziciji moguće podješavanje +4,5 mm / +8 mm

## ⊕ Riex NK35 Push to open za vrata, vanjski sa magnetom

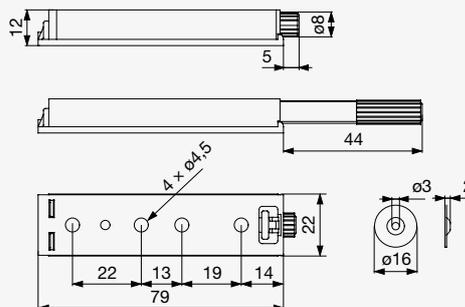

Boja

Kod

Srebrna

F003040

- U zatvorenoj poziciji moguće podješavanje +4,5 mm / +8 mm

# IF K Push

## ● IF K PUSH TECH Push to open za vrata



○ Bijela

Boja	Tip	Kod
Bijela	Normalna	F002645
	Jaka	F002647
Siva	Normalna	F002646
	Jaka	F002648

- U zatvorenoj poziciji moguće podješavanje +1,5 / +8 mm



● Siva

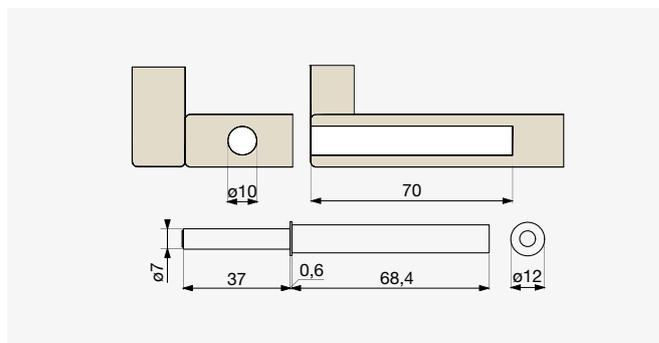

## ● IF K PUSH TECH Push to open za vrata sa magnetom



○ Bijela

Boja	Tip	Kod
Bijela	Normalna	F002649
	Jaka	F002651
Siva	Normalna	F002650
	Jaka	F002652

- Uključene su 2 vrste magnetnih kontradijelova – samoljepljivi i uvrtni
- U zatvorenoj poziciji moguće podješavanje +1,5 / +8 mm



● Siva

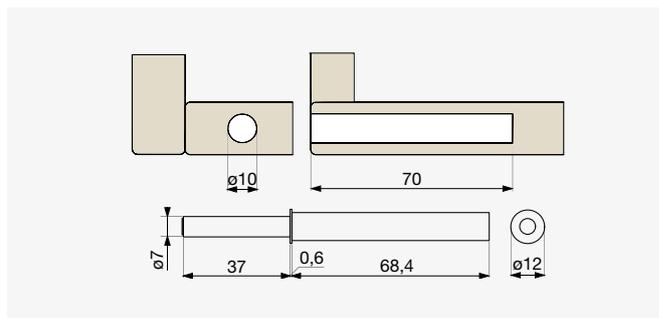



## ● IF K PUSH TECH Adapter



○ Kućište, bijela

Boja	Tip	Kod
Bijela	Kućište	F002653
	Adapter pločica	F002654
Siva	Kućište	F002655
	Adapter pločica	F003323

• Za vanjsko rešenje, potrebni su i kućište i pločica



○ Adapter pločica, bijela

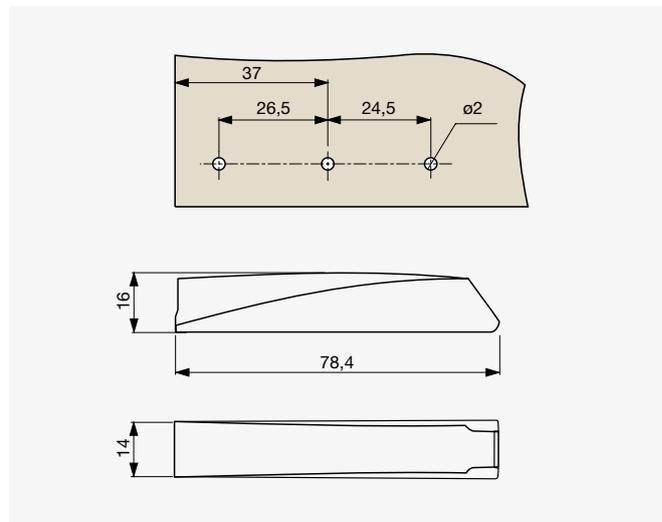

● Kućište, siva



● Adapter pločica, siva



01  
02  
03  
04  
05  
06  
07  
08  
09  
10  
11  
12  
13  
14  
15  
16  
17  
18

# Mehanizmi za otvaranje

Mehanizmi za otvaranje [nagib] olakšavaju otvaranje vrata namještaja prema gore ili dolje. Mehanizmi za podizanje dizajnirani su kao pomoć pri otvaranju vrata, a neki od njih također mogu prigušiti zatvaranje vrata kako bi ih učinili ugodnijim za korištenje. Kod asortimana klipova, funkciju otvaranja dijelimo na automatsku [vrata se uvijek otvaraju potpuno automatski] i zaustavljanje trenjem [vrata ostaju otvorena u bilo kojem položaju]. U našoj ponudi osim robne marke RIEX pronaći ćete i proizvode renomiranog brenda Italiana Ferramenta.



---

● <b>KIARO Padajući sustavi</b>	<b>3.3</b>
IF KIARO	3.3
IF KIARO EASY	3.5
<hr/>	
● <b>Mehanizmi za otvaranje sa klipom</b>	<b>3.7</b>
Riex mehanizmi za otvaranje sa klipom	3.7
IF mehanizmi za otvaranje sa klipom	3.11
<hr/>	
● <b>Ostali mehanizmi za otvaranje</b>	<b>3.16</b>

---

# KIARO Padajući sustavi

## ● IF KIARO Set



KIARO je sustav otvaranja vrata prema dolje [padajući] sa skrivenim mehanizmom koji omogućuje podešavanje postavki ovisno o težini i dimenzijama vrata.

**Značajke i prednosti:**

- Minimalistički i elegantan dizajn
- Dvostrani mehanizam – isti mehanizam se može postaviti i na desnu i na lijevu stranu
- Jednostavna ugradnja

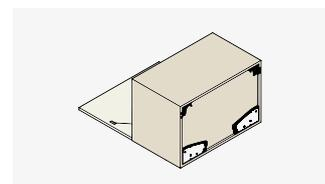
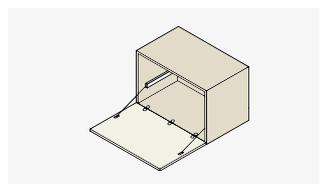

**Set sadrži:**

- KIARO mehanizam
- Profil 550 mm
- Vidljive i skrivene bravice
- Dodaci za spajanje

Boja	Model	Kod	Duljina [mm]
Svijetlo siva [T Met 9007]	KIARO	F002683	550
	KIARO S [tih]	F002685	

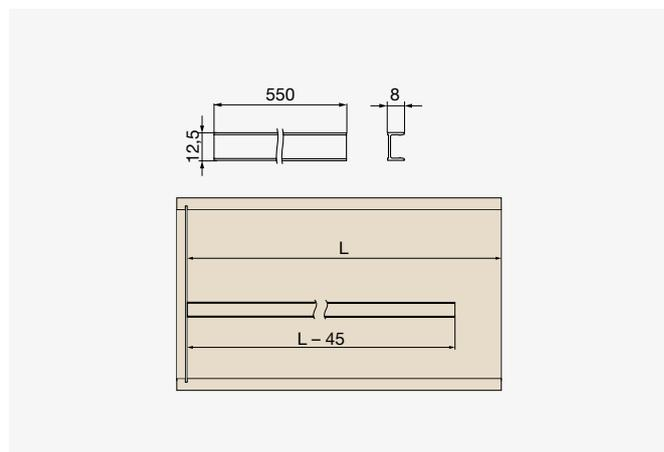
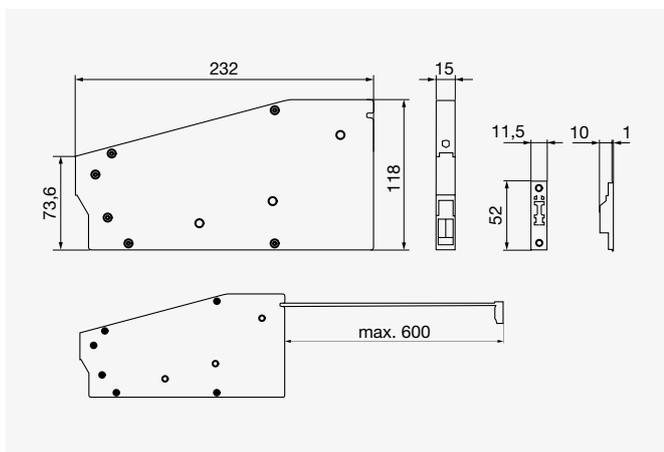

Blago otvaranje

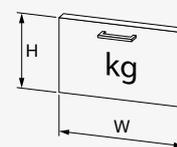
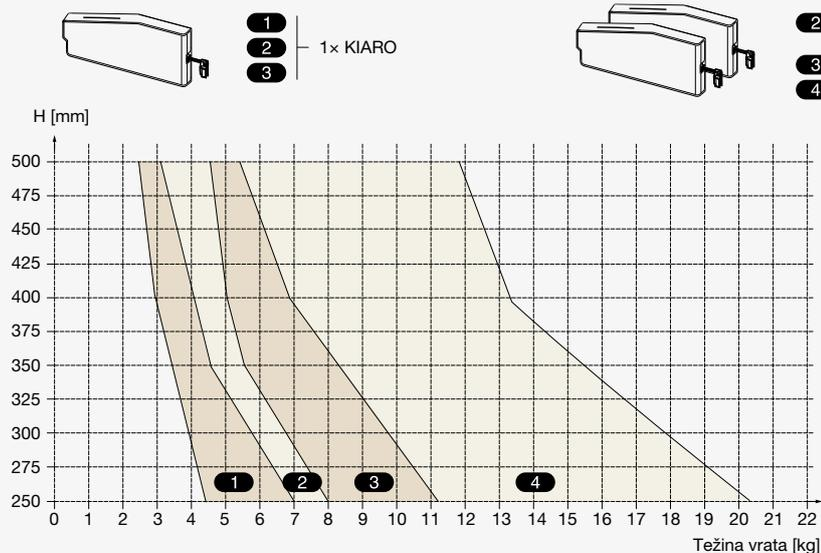

Zaustavljanje trenja

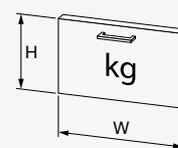
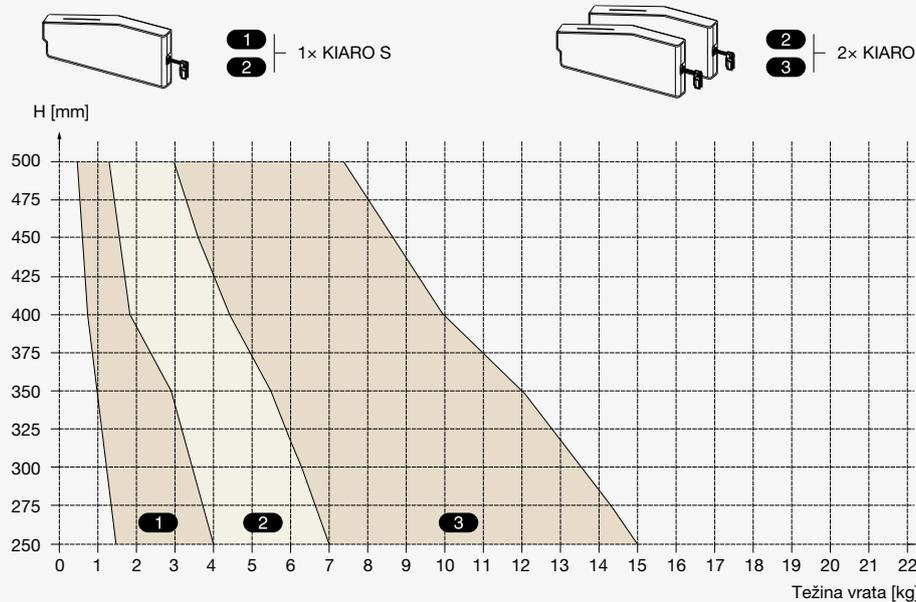

## ● IF KIARO oprema za LED



Električne komponente za integraciju sa klijentovom LED ugradnjom:

- Kabeli
- Senzor otvaranja

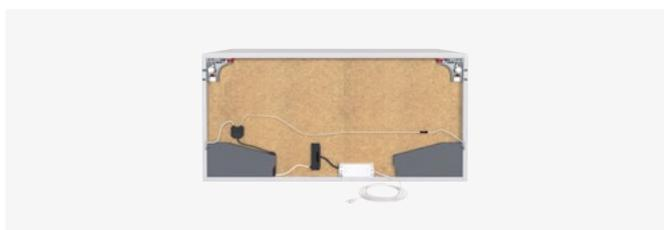

Tip	Kod
KIARO oprema za LED	F002684

03

## ● IF KIARO EASY Set [IF KIARO JEDNOSTAVAN set]



KIARO Easy je elegantan sustav otvaranja za vrata koja se otvaraju prema dolje definirana minimalističkim oblicima i izrazito glatkim kretanjem.

**Značajke i prednosti:**

- Minimalistički dizajn
- Univerzalni mehanizam koji se može montirati s obje strane
- Jednostavno podešavanje sile mehanizma i kuta otvaranja
- Širok izbor dimenzija otvora vrata
- Dvije vrste nosača u paketu

**Set sadrži:**

- KIARO EASY mehanizam
- Vidljive i skrivene spojnice
- Dodaci za spajanje



● Antracit

● Svijetlo siva



Boja

Model

Kod

Antracit	Blag	F004522
	Snažan	F005224
Svijetlo siva	Blag	F005223
	Snažan	F005498

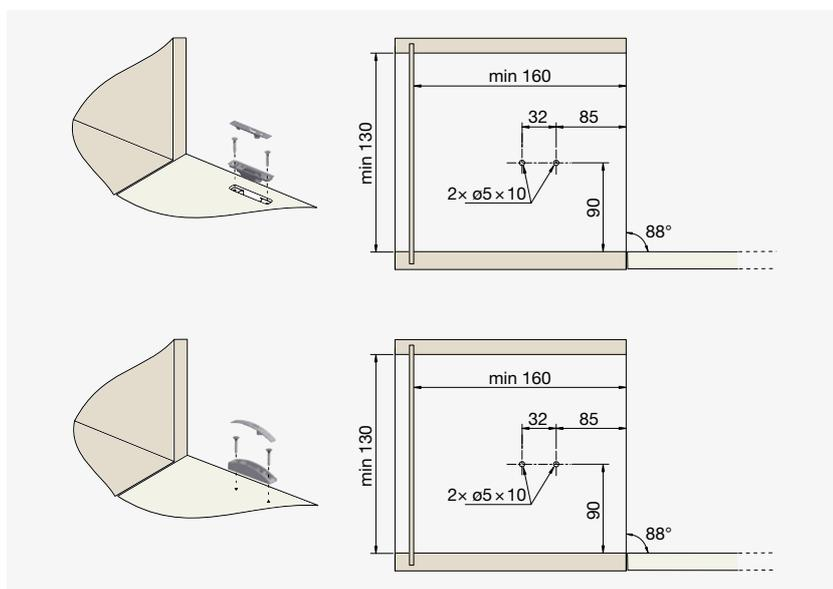

01  
02  
03  
04  
05  
06  
07  
08  
09  
10  
11  
12  
13  
14  
15  
16  
17  
18

Jedan KIARO EASY

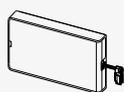

- 1 1x KIARO EASY SOFT [KIARO JEDNOSTAVAN, BLAG SUSTAV]
- 2 1x KIARO EASY SOFT OR STRONG [KIARO JEDNOSTAVAN, BLAG ili SNAŽAN SUSTAV]
- 3 1x KIARO EASY STRONG [KIARO JEDNOSTAVAN SNAŽAN SUSTAV]

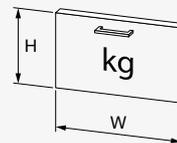
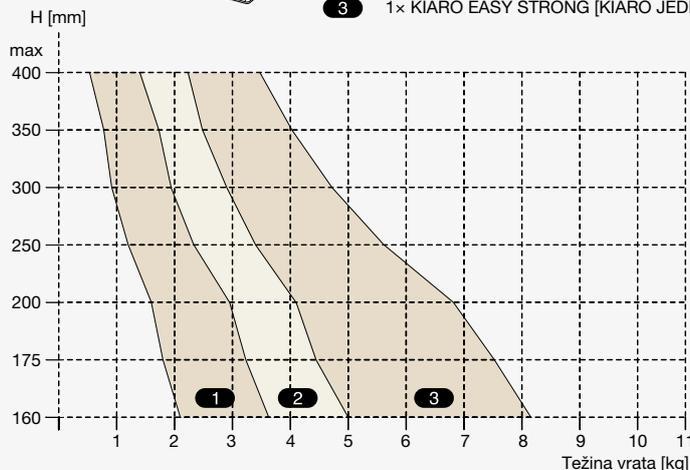

Dupli KIARO EASY

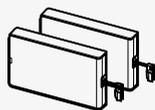

- 1 2x KIARO EASY SOFT [KIARO JEDNOSTAVAN, BLAG SUSTAV]
- 2 2x KIARO EASY SOFT OR STRONG [KIARO JEDNOSTAVAN, BLAG ili SNAŽAN SUSTAV]
- 3 2x KIARO EASY STRONG [KIARO JEDNOSTAVAN SNAŽAN SUSTAV]

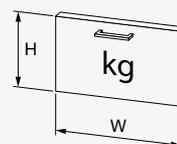
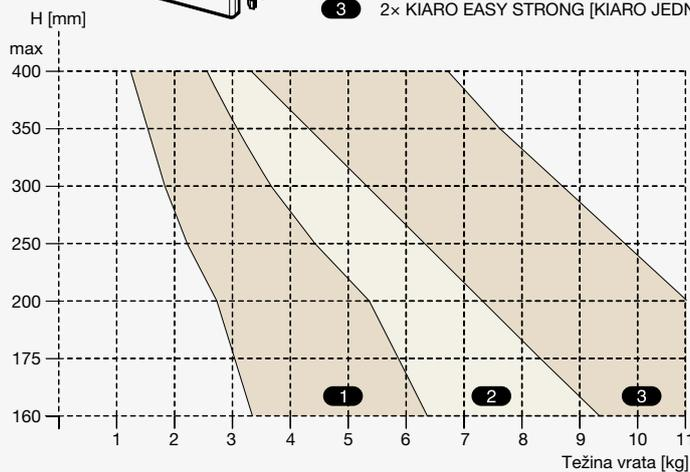

03

# Mehanizmi za otvaranje sa klipom

## ○ Riex NV22 Podizni automatski amortizer 245 mm



● Srebrna

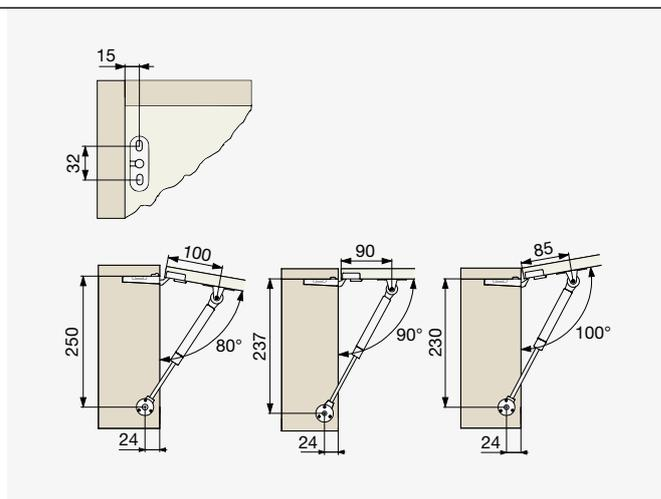

○ Bijela

- Duljina 245 mm
- Vrata se otvaraju do maksimalne pozicije
- U kombinaciji sa spojnicom, sa ili bez opruge

Snaga [N]	Srebrna	Bijela
30	F000345	F000350
60	F000346	F000351
80	F000347	F000352
100	F000348	F000353
120	F000349	F000354

Širina vrata [mm]	Visina vrata [mm]					
	300	350	400	450	500	550
300	1 × 30 N [1,1–1,3 kg]	1 × 30 N [1,3–1,5 kg]	1 × 60 N [1,5–1,7 kg]	1 × 60 N [1,7–1,9 kg]	1 × 80 N [1,9–2,1 kg]	1 × 80 N [2,1–2,2 kg]
400	1 × 60 N [1,5–1,7 kg]	1 × 80 N [1,7–2 kg]	1 × 80 N [2–2,2 kg]	1 × 100 N [2,2–2,4 kg]	1 × 100 N [2,4–2,7 kg]	1 × 120 N [2,7–2,9 kg]
500	1 × 60 N [1,8–2,1 kg]	1 × 80 N [2,1–2,4 kg]	1 × 100 N [2,4–2,7 kg]	1 × 100 N [2,7–3 kg]	1 × 120 N [3–3,3 kg]	1 × 120 N [3,3–3,6 kg]
600	1 × 80 N [2,2–2,5 kg]	1 × 80 N [2,5–2,9 kg]	1 × 100 N [2,9–3,3 kg]	2 × 60 N [3,3–3,6 kg]	2 × 80 N [3,6–4 kg]	2 × 80 N [4–4,3 kg]
700	1 × 80 N [2,6–3 kg]	1 × 100 N [3–3,4 kg]	2 × 60 N [3,4–3,8 kg]	2 × 60 N [3,8–4,2 kg]	2 × 80 N [4,2–4,6 kg]	2 × 100 N [4,6–5,1 kg]
800	1 × 100 N [2,9–3,4 kg]	2 × 60 N [3,4–3,9 kg]	2 × 60 N [3,9–4,3 kg]	2 × 80 N [4,3–4,8 kg]	2 × 100 N [4,8–5,3 kg]	2 × 100 N [5,3–5,8 kg]
900	1 × 100 N [3,3–3,8 kg]	2 × 60 N [3,8–4,3 kg]	2 × 60 N [4,3–4,9 kg]	2 × 80 N [4,9–5,4 kg]	2 × 100 N [5,4–6 kg]	2 × 100 N [6–6,5 kg]
1000	2 × 60 N [3,6–4,2 kg]	2 × 60 N [4,2–4,8 kg]	2 × 80 N [4,8–5,4 kg]	2 × 100 N [5,4–6 kg]	2 × 100 N [6–6,6 kg]	2 × 120 N [6,6–7,2 kg]

Težina naznačena u tablici se odnosi na težinu rabljenih vrata [sa ručkom].



## ● Riex NV33 Podizni amortizer za zaustavljanje trenja 245 mm



● Srebrna

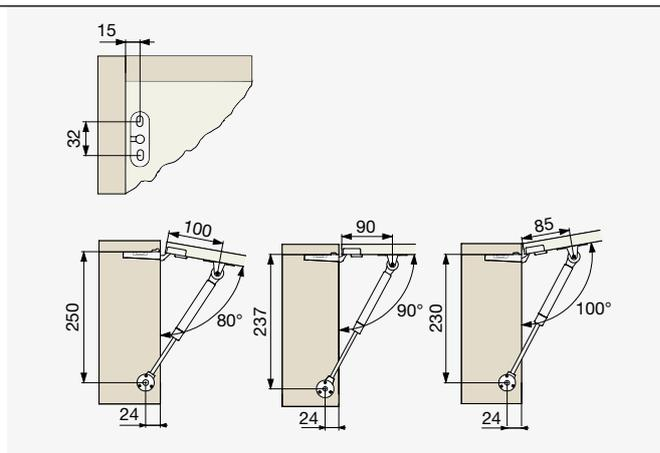

○ Bijela

- Duljina 245 mm
- Vrata se zaustavljaju prilikom otvaranja u svim pozicijama
- U kombinaciji sa spojnicama, sa ili bez opruge

Snaga [N]	Srebrna	Bijela
60	F000356	F000360
80	F000357	F000361
100	F000358	F000362
120	F000359	F000363

Širina vrata [mm]	Visina vrata [mm]				
	350	400	450	500	550
450	1 × 60 N [1,6–2,8 kg]	1 × 80 N [1,8–2,4 kg]	1 × 80 N [2,1–2,4 kg]	1 × 100 N [2,4–2,6 kg]	1 × 100 N [2,6–2,9 kg]
600	1 × 80 N [2–2,8 kg]	1 × 80 N [2,4–2,9 kg]	1 × 100 N [2,9–3,3 kg]	2 × 60 N [3,3–3,6 kg]	2 × 80 N [3,6–4 kg]
800	1 × 100 N [2,8–3,7 kg]	2 × 60 N [2,9–3,5 kg]	2 × 60 N [3,9–4,3 kg]	2 × 80 N [4,3–4,8 kg]	2 × 100 N [4,8–5,3 kg]
1000	2 × 60 N [3,7–4,5 kg]	2 × 80 N [3,5–4,8 kg]	2 × 80 N [4,8–5,4 kg]	2 × 100 N [5,4–6 kg]	2 × 100 N [6–6,6 kg]

Težina naznačena u tablici se odnosi na težinu rabljenih vrata [sa ručkom].

## ● Riex NV22 / NV33 Poklopac za podizne amortizere



● Srebrna



○ Bijela

- Jednostavna ugradnja
- Pokriva cijelu šipku na klipu

Boja	Kod
Srebrna	F002905
Bijela	F002904

03

**⊖ Riex NV10 Amortizer za automatsko podizanje 180 mm**



- Duljina 180 mm
- Za vrata 230–350 mm
- Maksimalna težina vrata 3,5 kg

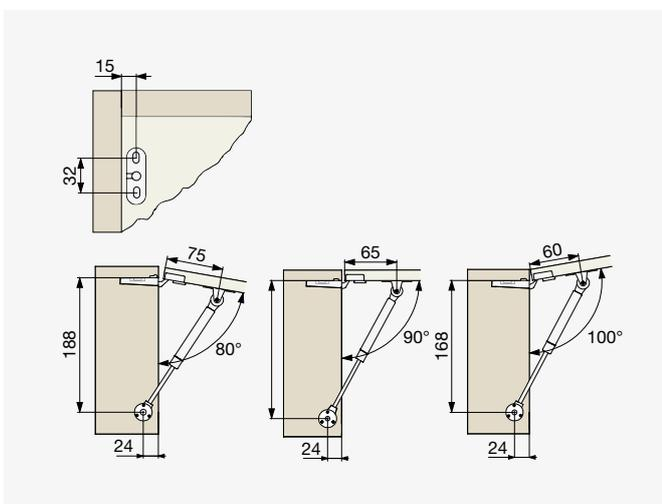

Snaga [N]	Boja	Kod
80	Srebrna	F000366

## ● Riex NV15 Mehanizmi za spuštanje [padajući] 245 mm



● Srebrna

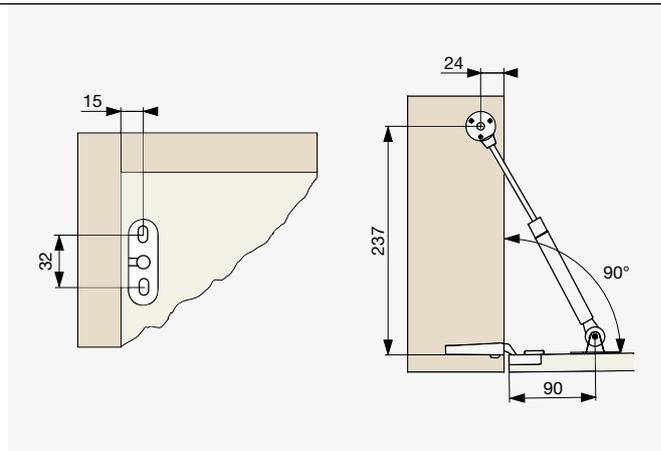

○ Bijela

• Duljina 245 mm

Snaga [N]	Srebrna	Bijela
80	F000364	F000365

● IF K12 Amortizer za automatsko podizanje 244 mm

03

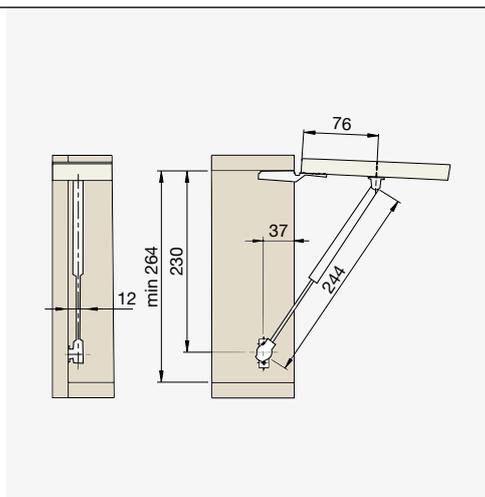

- Registrirani dizajn
- Minimalistički dizajn i elegancija u svim detaljima
- Jednostavan za ugradnju
- 3 jačine u ponudi

Snaga [N]	Srebrna
50	F002667
80	F002668
100	F002669

Širina vrata [mm]	Visina vrata [mm]				
	300	350	400	450	500
200-400	1 × 50 N [1 kg]	1 × 50 N [1 kg]	1 × 50 N [1 kg]	1 × 50 N [1 kg]	1 × 50 N [1 kg]
300-600	1 × 80 N [1,5-2 kg]	1 × 80 N [1,5 kg]	1 × 80 N [1,5 kg]	2 × 50 N [1,5-2,5 kg]	2 × 50 N [1,5-2 kg]
500-800	2 × 50 N [2-3 kg]	2 × 50 N [1,5-2,5 kg]	2 × 50 N [1,5-2,5 kg]	2 × 80 N [2,5-4,5 kg]	2 × 80 N [2-3,5 kg]
800-1600	2 × 80 N [3-6,5 kg]	2 × 80 N [2,5-5,5 kg]	2 × 80 N [2,5-4,5 kg]	2 × 80 N [2,5-4,5 kg]	2 × 100 N [3,5-5 kg]
800-1600	2 × 100 N [7-7,5 kg]	2 × 100 N [5,5-6,5 kg]	2 × 100 N [4,5-5,5 kg]	×	×

Težina naznačena u tablici se odnosi na težinu rabljenih vrata [sa ručkom].



● IF K12 Klip za spuštanje [padajući]



- Registrirani dizajn
  - Minimalistički dizajn i elegancija u svim detaljima
  - Jednostavan za ugradnju
- 3 duljine u ponudi

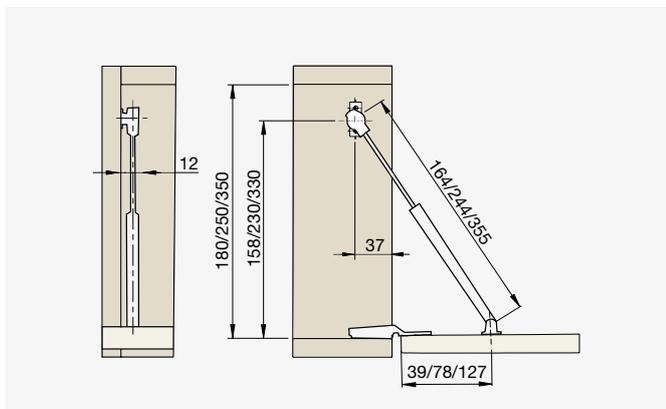

Duljina [mm]	Kod	Visina vrata [mm]
164	F002670	200–300
244	F002671	290–500
355	F002672	390–600



● IF Kraby amortizer za podizanje, sa zaustavljanjem trenja

03

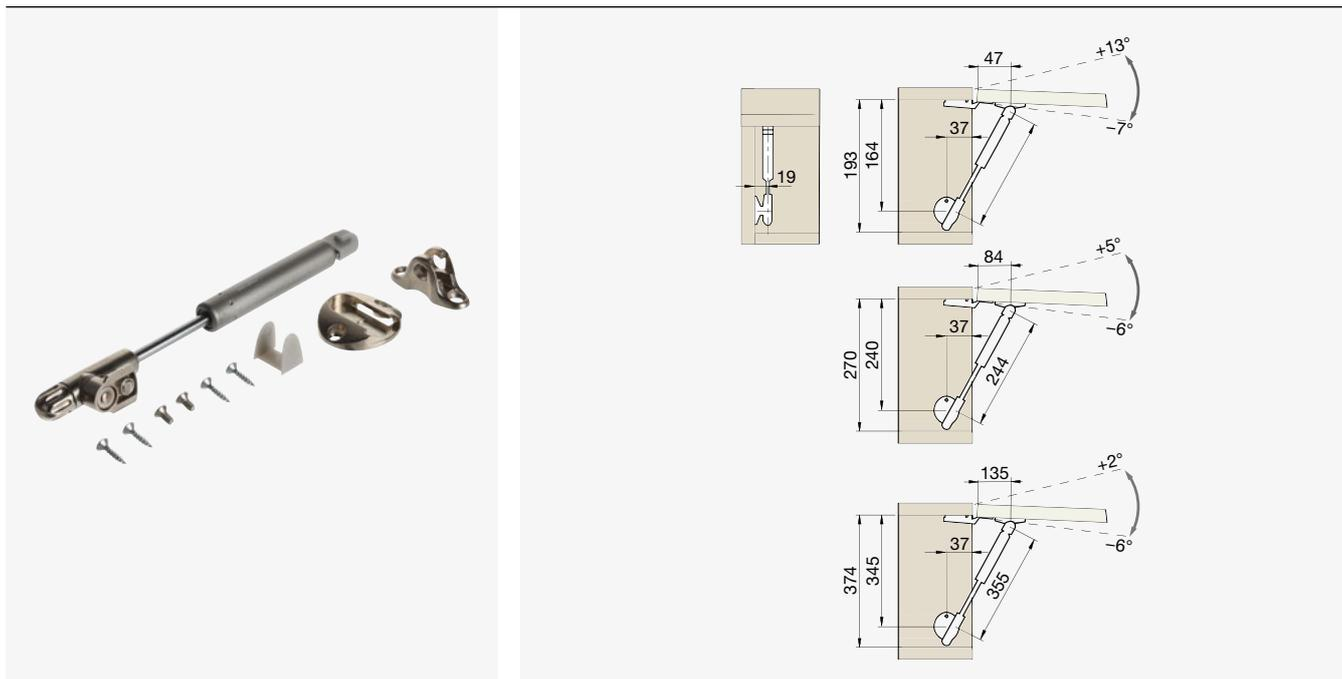

Duljina [mm]	Snaga [N]	Kod
164	45	F002673
	60	F002674
244	45	F002675
	60	F002676
	90	F002677
355	60	F002678
	90	F002679

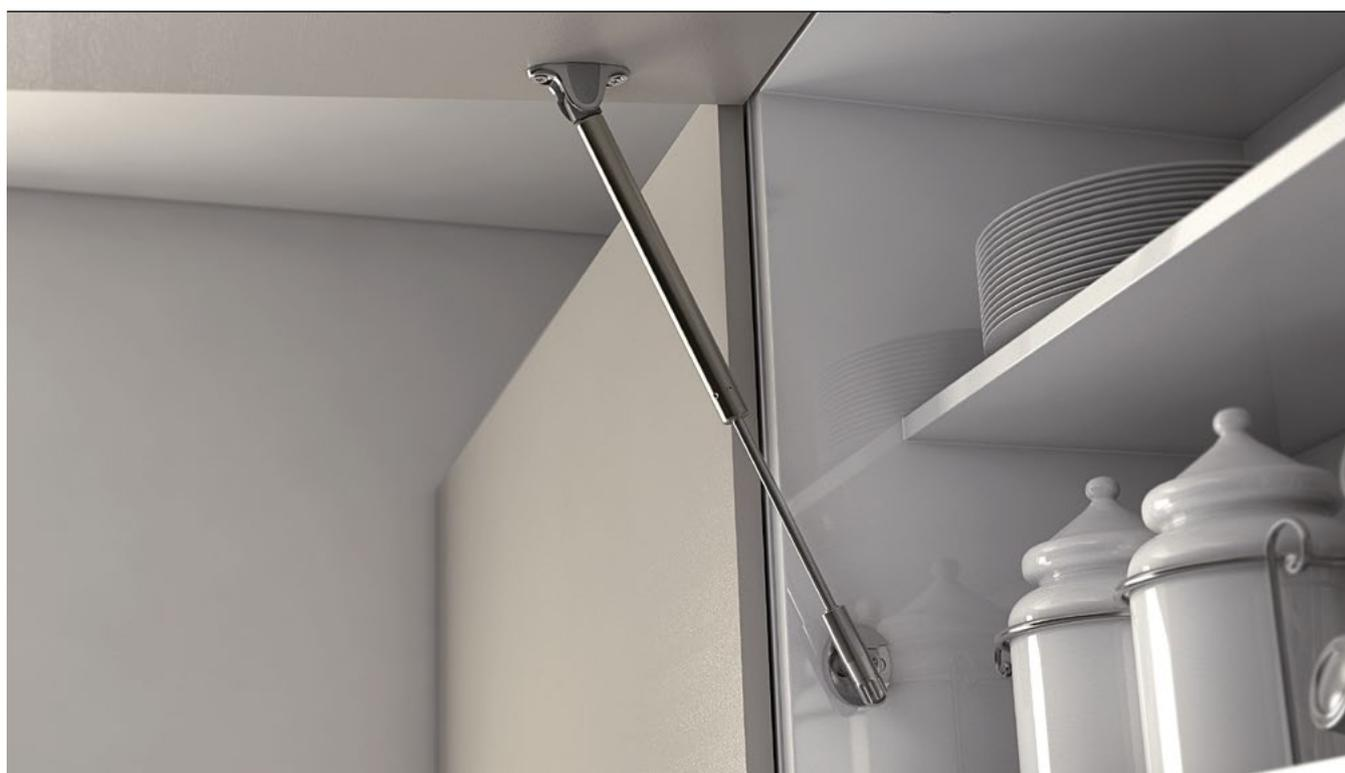

## L = 164 mm

Širina vrata [mm]	Visina vrata [mm]	
	230–274	275–325
250–350	1 × 45 N [1–2 kg]	1 × 60 N [1–2 kg]
400–800	2 × 45 N [2–5 kg]	2 × 45 N [2–3,5 kg]
800–1600	2 × 60 N [6–7,5 kg]	2 × 60 N [3,5–5,5 kg]

Težina naznačena u tablici se odnosi na težinu rabljenih vrata [sa ručkom].

## L = 244 mm

Širina vrata [mm]	Visina vrata [mm]				
	300	350	400	450	500
200–400	1 × 45 N [1–2 kg]	1 × 45 N [1–1,5 kg]	1 × 45 N [1–1,5 kg]	1 × 60 N [1–2 kg]	2 × 45 N [1–3 kg]
300–600	1 × 60 N [2–3 kg]	1 × 60 N [1,5–2,5 kg]	1 × 60 N [1,5–2,5 kg]	2 × 45 N [2–3,5 kg]	2 × 60 N [3–5,5 kg]
500–800	2 × 45 N [3–6 kg]	2 × 45 N [2,5–4,5 kg]	1 × 45 N [2,5–4 kg]	2 × 60 N [3,5–6,5 kg]	2 × 90 N [5,5–7 kg]
800–1600	2 × 60 N [6–9,5 kg]	2 × 60 N [4,5–8 kg]	2 × 60 N [4–7,5 kg]	2 × 90 N [6,5–9,5 kg]	2 × 120 N [7–8,5 kg]

Težina naznačena u tablici se odnosi na težinu rabljenih vrata [sa ručkom].

## L = 355 mm

Širina vrata [mm]	Visina vrata [mm]					
	400	450	500	550	600	700
200–400	2 × 45 N [1–8,5 kg]	2 × 45 N [1–7,5 kg]	2 × 45 N [1–7,5 kg]	2 × 45 N [1–5,5 kg]	2 × 45 N [1–5,5 kg]	2 × 45 N [1–3,5 kg]
300–600	2 × 60 N [8,5–13 kg]	2 × 60 N [7,5–11,5 kg]	2 × 60 N [7,5–11,5 kg]	2 × 60 N [5,5–9,5 kg]	2 × 60 N [5,5–8,5 kg]	2 × 60 N [3,5–7,5 kg]
500–800	×	2 × 90 N [11,5–13 kg]	2 × 90 N [11,5–13 kg]	2 × 90 N [9,5–13 kg]	2 × 90 N [8,5–13 kg]	2 × 90 N [7,5–9,5 kg]

Težina naznačena u tablici se odnosi na težinu rabljenih vrata [sa ručkom].

● IF Kraby padajući amortizer

03

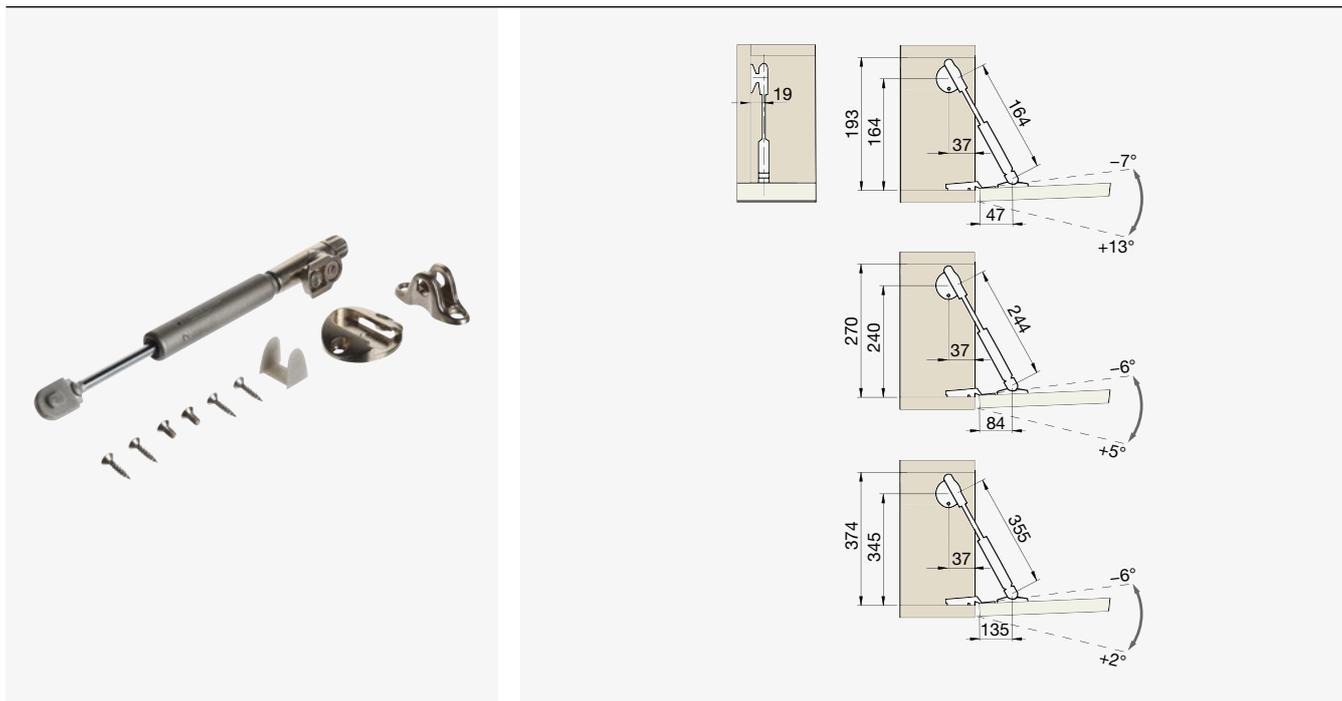

Duljina [mm]	Kod	Visina vrata [mm]
164	F002680	200-284
244	F002681	280-500
355	F002682	380-600





# Ostali mehanizmi za otvaranje

## ⊕ Riex NV05 Preklopna ručica

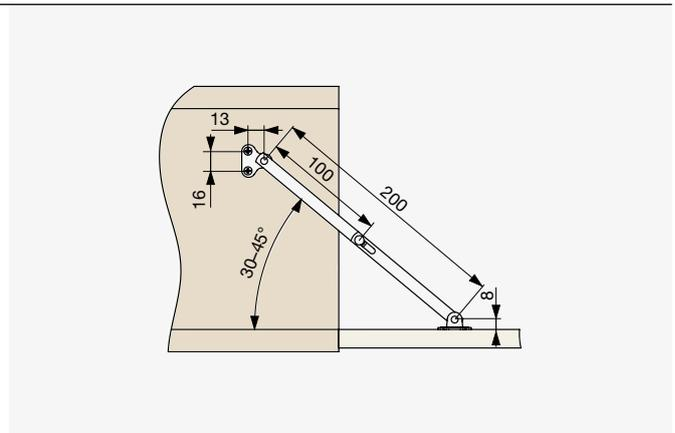

Duljina [mm]	Kod
200	F003571

# Ručkice, profili i vješalice

Ručkice, kvake, profili i vješalice za ormare niz su elementa koji su na granici između dizajna i funkcionalnosti. Pravilan odabir ručkica može upotpuniti izgled vrata namještaja i naglasiti kvalitetu korištenih materijala. U našoj ponudi možete birati između različitih vrsta, boja, površina, materijala i oblika prilagođenih Vašim potrebama. U mnogim slučajevima također ćete pronaći dizajnerske veze između ručki i vješalica, što vam omogućava da radite obrisati u širem kontekstu.



● Pregled ručkice, ručkica, profila i vješalice	4.3
● Metalne ručkice i kvake	4.9
● Porculanske ručkice i kvake	4.63
● Plastične ručkice i kvake	4.67
● Drvene ručkice i kvake	4.69
● Vijci i vijčani profili	4.77
● Gola profili	4.81
RiexTouch XG20 Bare L oblik	4.82
RiexTouch XG20 Bare C oblik	4.84
Pribor za uređaj RiexTouch XG20 Gola	4.86
RiexTouch XG10 Gola	4.87
● Vješalice	4.89

04

**Pregled ručkica, brisati, profila i vješalica**

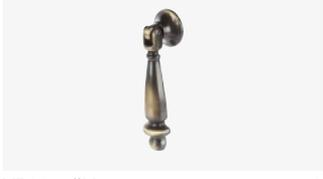
			
XH60 ručkica 4.10	XH60 ručkica 4.10	XH59 ručkica 4.11	XH59 ručkica 4.11
			
XH62 ručkica 4.12	XH62 ručkica 4.12	XH49 ručkica 4.13	XH49 ručkica 4.13
			
XH54 ručkica 4.14	XH52 ručkica 4.14	XR31 ručkica 4.15	XR31 ručkica 4.15
			
XR24 ručkica 4.16	XR24 ručkica 4.16	XH53 ručkica 4.17	XR25 ručkica 4.17
			
XR30 ručkica 4.18	XR30 ručkica 4.18	XR30 ključ za ručku 4.19	XR30 štitnici 4.19
			
XR30 ručkica 4.19	XR32 ručkica 4.20	XR23 ručkica 4.20	XR16 ručkica 4.21
			
XR16 ručkica 4.21	XR16 ručkica 4.22	XR16 ručkica 4.22	XR04 ručkica 4.23
			
XR05 ručkica 4.23	XR15 ručkica 4.24	XH48 ručkica 4.24	XR27 ručkica 4.25

			
XR27 ručkica 4.25	XR26 ručkica 4.26	XR26 ručkica 4.26	XH51 ručkica 4.27
			
XH50 ručkica 4.27	XZ13 ručkica 4.28	XK19 ručkica 4.28	XH01 ručkica 4.29
			
XH14 ručkica 4.29	XH12 ručkica 4.30	XH03 ručkica 4.30	XH05 ručkica 4.31
			
XH10 ručkica 4.31	XH35 ručkica 4.32	XH44 ručkica 4.32	XH19 ručkica 4.33
			
XH43 ručkica 4.33	XH08 ručkica 4.34	XH45 ručkica 4.34	XH36 ručkica 4.35
			
XH40 ručkica 4.35	XH47 ručkica 4.36	XH24 ručkica 4.36	XH22 ručkica 4.37
			
XH28 ručkica 4.37	XH07 ručkica 4.38	XH32 ručkica 4.38	XH02 ručkica 4.39
			
XH42 ručkica 4.39	XH31 ručkica 4.40	XH30 ručkica 4.40	XH06 ručkica 4.41

			
XH26 ručkica 4.41	XH23 ručkica 4.42	XH18 ručkica 4.42	XH25 ručkica 4.43
			
XH20 ručkica 4.43	XH29 ručkica 4.43	XH11 ručkica 4.44	XH16 ručkica 4.44
			
XH13 ručkica 4.45	XR19 ručkica 4.45	XR20 ručkica 4.45	XH21 ručkica 4.46
			
XH46 ručkica 4.46	XH27 ručkica 4.47	XZ09 ručkica 4.47	XZ11 ručkica 4.48
			
XZ04 ručkica 4.48	XZ03 ručkica 4.49	XZ02 ručkica 4.49	XZ01 ručkica 4.50
			
XZ10 ručkica 4.50	XZ05 ručkica 4.51	XZ06 ručkica 4.51	XZ07 ručkica 4.52
			
XZ08 ručkica 4.52	XZ12 ručkica 4.53	XK01 ručkica 4.53	XK02 ručkica 4.54
			
XK11 ručkica 4.54	XK05 ručkica 4.54	XK03 ručkica 4.55	XK12 ručkica 4.55

	XK13 ručkica	4.56		XK15 ručkica	4.56		XK08 ručkica	4.56		XV28 ručkica	4.57
	XK14 ručkica	4.57		XK16 ručkica	4.57		XK09 ručkica	4.58		XH04 ručkica	4.59
	XH09 ručkica	4.59		XH33 ručkica	4.60		XH34 ručkica	4.60		XH37 ručkica	4.61
	XK10 ručkica	4.61		XK07 ručkica	4.62		XK06 ručkica	4.62		XR28 ručkica	4.64
	XR28 ručkica	4.64		XR29 ručkica	4.65		XR29 ručkica	4.65		XR21 ručkica	4.66
	XR22 ručkica	4.66		XD01 ručkica	4.67		XD02 ručkica	4.67		XD02 ručkica	4.68
	XD03 ručkica	4.68		XD04 ručkica	4.68		XT10 ručkica	4.70		XT07 ručkica	4.70
	XT13 ručkica	4.71		XT08 ručkica	4.71		XT09 ručkica	4.72		XT14 ručkica	4.72

			
XT12 ručkica 4.73	XT06 ručkica 4.73	XT01 ručkica 4.74	XT04 ručkica 4.74
			
XT02 ručkica 4.75	XT03 ručkica 4.75	XT05 ručkica 4.76	XT11 ručkica 4.76
			
XT10 ručkica 4.76	XP01 profil 4.78	XP41 profil 4.78	XP45 profil 4.79
			
XP60 profil 4.80	XP63 profil 4.80	XP65 profil 4.80	XG20 Gola L 4.82
			
XG20 Gola L 4.83	XG20 Gola L 4.83	XG20 Gola L 4.83	XG20 Gola C 4.84
			
XG20 Gola C 4.85	XG20 Gola C 4.85	XG20 Gola C 4.85	XG10 Bare okomiti 4.87
			
XG10 Bare vodoravni 4.88	XG10 Gola vodoravni 4.88	XV39 kuka 4.90	XV40 kuka 4.90
			
XV43 kuka 4.90	XV42 kuka 4.91	XV41 kuka 4.91	XV23 kuka 4.92



	XV01 kuka	4.92		XV14 kuka	4.93		XK09 kuka	4.93		XV25 kuka	4.93
	XV34 kuka	4.94		XV33 kuka	4.94		XV28 kuka	4.95		XV38 kuka	4.95
	XV35 kuka	4.95		XV32 kuka	4.96		XV21 kuka	4.96		XV19 kuka	4.97
	XV24 kuka	4.97		XV04 kuka	4.98		XV03 kuka	4.98		XV07 kuka	4.99
	XV05 kuka	4.99		XV11 kuka	4.100		XV09 kuka	4.100		XV13 kuka	4.101
	XV31 kuka	4.101		XV30 kuka	4.102		XV02 kuka	4.103		XV08 kuka	4.103
	XV06 kuka	4.103		XV12 kuka	4.104		XV10 kuka	4.104			

# Metalne ručkice

04



● Citterio Giulio XH60 ručkica



● Mat zlato ● Mat srebro

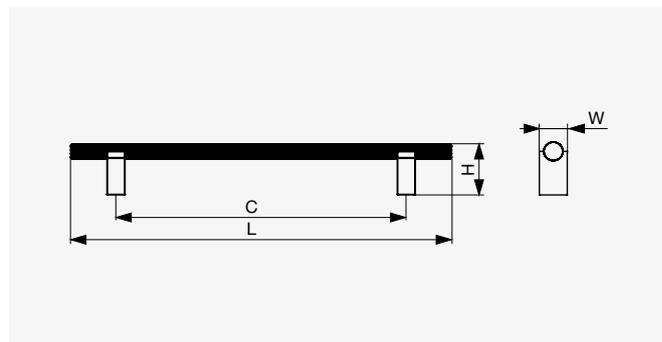

● Mat crna

Dimenzija C [mm]	Mat crno	Mat zlato	Mat srebro	Dimenzija L [mm]	Dimenzija H [mm]	Dimenzija W [mm]
160	F003280	F003281	F003282	210	29	15
320	F003283	F003284	F003285	370		

● Citterio Giulio XH60 ručkica



● Mat zlato ● Mat srebro

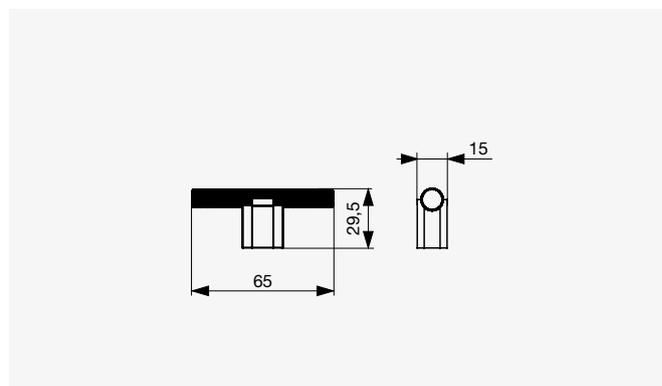

● Mat crna

Mat crna	Mat zlato	Mat srebro
F003286	F003287	F003288

01  
02  
03  
04  
05  
06  
07  
08  
09  
10  
11  
12  
13  
14  
15  
16  
17  
18

04

### ● Citterio Giulio XH59 ručkica



● Mat crna      ● Mat zlato      ● Mat srebro

Isti dizajn nosača polica na str. 14.55.

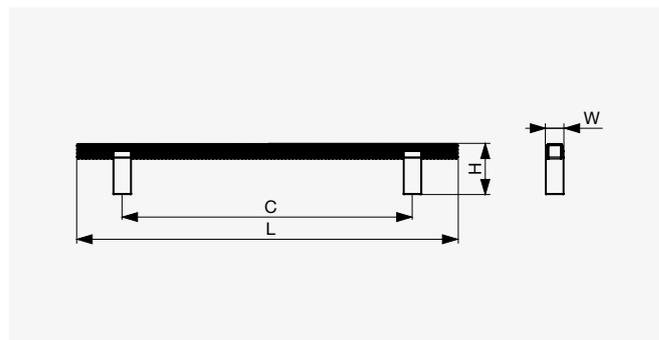

● Francuska patinirana bronca

Dimenzija C [mm]	Francuska patinirana bronca	Mat crna	Mat zlato	Mat srebro	Dimenzija L [mm]	Dimenzija H [mm]	Dimenzija W [mm]
160	F003273	F003271	F003272	F005459	210	28,5	10
320	F003276	F003274	F003275	F005460	370		

### ● Citterio Giulio XH59 ručkica



● Mat crna      ● Mat zlato      ● Mat srebro

Isti dizajn nosača polica na str. 14.55.

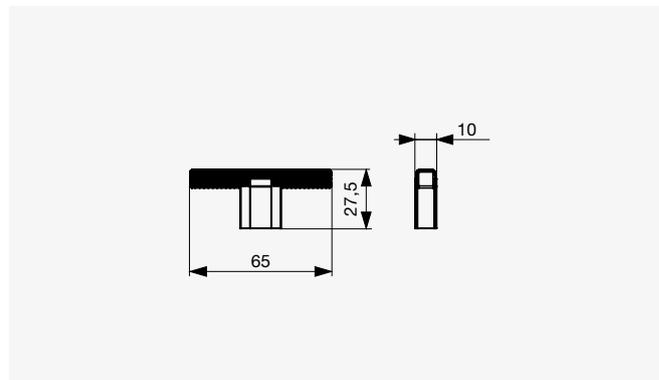

● Francuska patinirana bronca

Francuska patinirana bronca	Mat crna	Mat zlato	Mat srebro
F003279	F003277	F003278	F005461

## ● Citterio Giulio XH62 ručkica

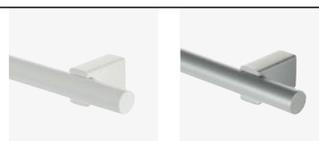

○ Mat bijela

● Mat krom

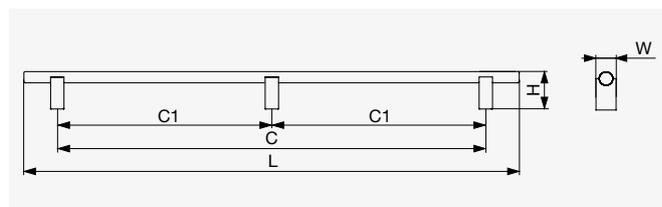

### ● Mat crna

Dimenzija C [mm]	Mat crna	Mat bijelo	Mat krom	Število nog	Dimenzija C1 [mm]	Dimenzija L [mm]	Dimenzija H [mm]	Dimenzija W [mm]
160	F005471	F005478	F005485	2	160	210		
320	F005472	F005479	F005486	2	320	370		
834	F005473	F005480	F005487	3	417	884		
1172	F005474	F005481	F005488	3	586	1222	29	15
1596	F005475	F005482	F005489	4	532	1645		
1920	F005476	F005483	F005490	5	480	1970		

## ● Citterio Giulio XH62 ručkica

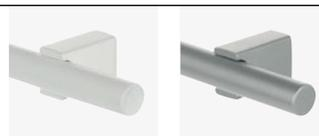

○ Mat bijela

● Mat krom

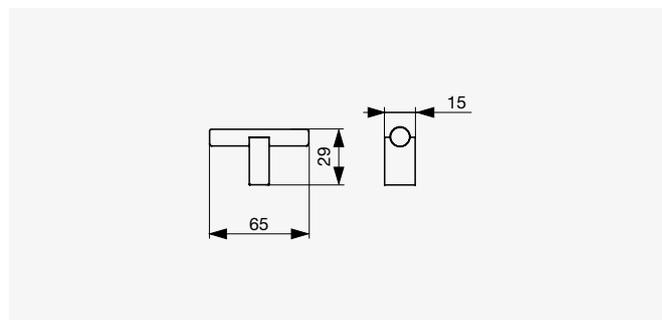

### ● Mat crna

Mat crna	Mat bijela	Mat krom
F005470	F005477	F005484

04

● Citterio Giulio XH49 ručkica



● Polirano krom / mat crna

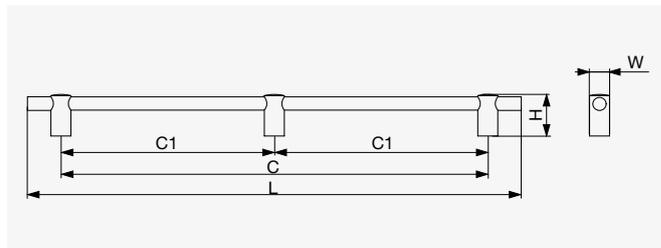

● Mat zlatno / mat crno

Dimenzija C [mm]	Mat zlatno / mat crno	Polirani krom / mat crna	Broj nogu	Dimenzija C1 [mm]	Dimenzija L [mm]	Dimenzija H [mm]	Dimenzija W [mm]
160	F003154	F003155	2	160	210		
320	F003156	F003157	2	320	370		
572	F005463	F005467	2	572	622	32	15
1074	F005464	F005468	3	537	1124		
1794	F005465	F005469	4	598	1844		

● Citterio Giulio XH49 ručkica



● Polirani krom / mat crna

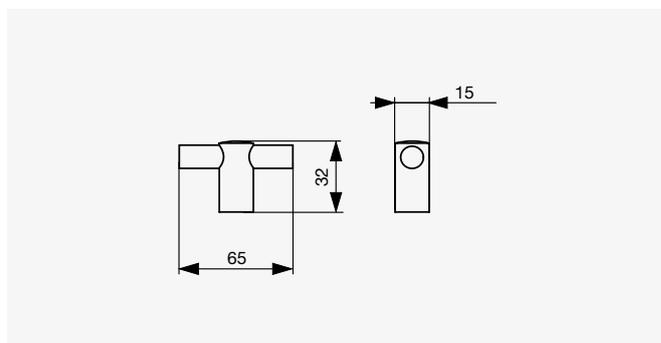

● Mat zlatno / mat crno

Mat zlatno /  
mat crno  
F005462

Polirani krom /  
mat crna  
F005466

## ● Citterio Giulio XH54 ručkica



● Polirano krom

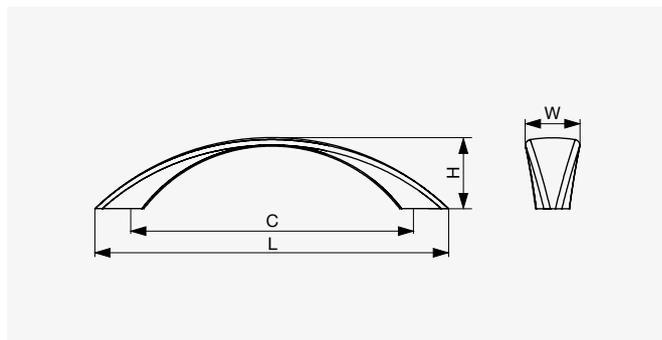

● Mat nikal

Dimenzija C [mm]	Mat nikal	Polirano krom	Dimenzija L [mm]	Dimenzija H [mm]	Dimenzija W [mm]
64	F003207	F003206	85	22	16
96	F003209	F003208	123	25	19

## ● Citterio Giulio XH52 ručkica



● Mat crna

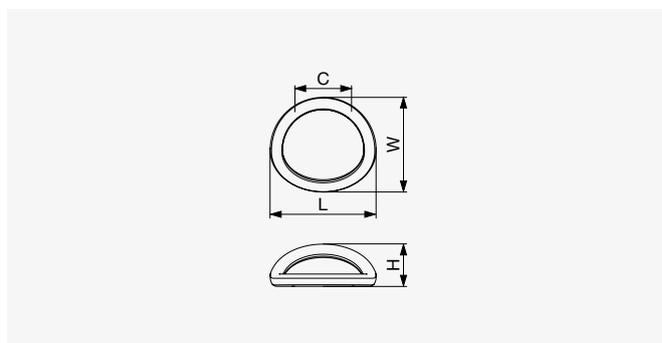

● Mat zlatna

Dimenzija C [mm]	Mat zlatna	Mat crna	Dimenzija L [mm]	Dimenzija H [mm]	Dimenzija W [mm]
32	F003175	F003174	60	24	54
96	F003177	F003176	106	35	98

04

● Citterio Giulio XR31 ručkica



● Prirodna bronca

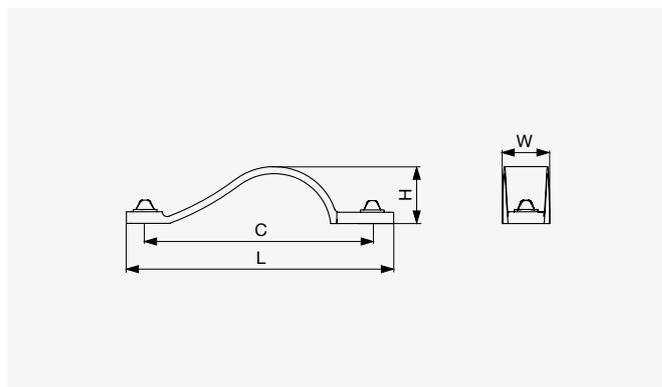

● Patinirano željezo

Dimenzija C [mm]	Patinirano željezo	Prirodna bronca	Dimenzija L [mm]	Dimenzija H [mm]	Dimenzija W [mm]
96	F003255	F003254	113	25	20
128	F003253	F003252	145		

● Citterio Giulio XR31 ručkica

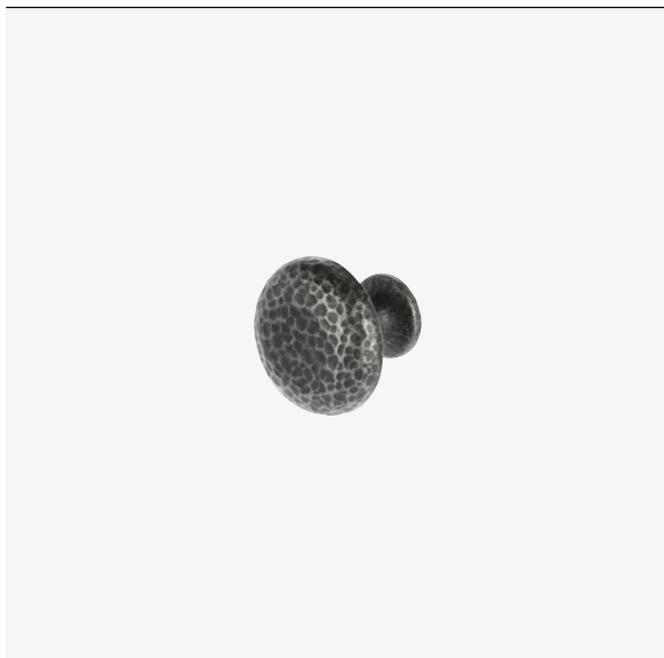

● Prirodna bronca

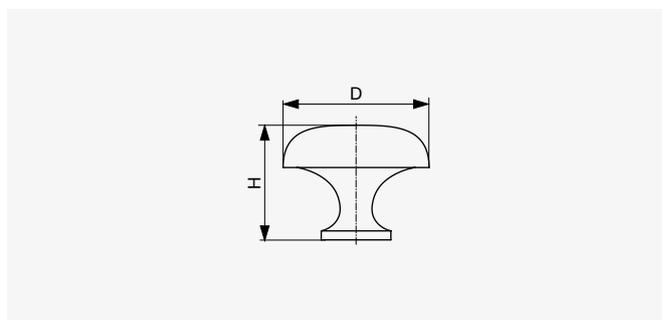

● Patinirano željezo

Veličina	Patinirano željezo	Prirodna bronca	Dimenzija D [mm]	Dimenzija H [mm]
Jedan mali	F003259	F003258	32	27
Velik	F003257	F003256	37	30



● Citterio Giulio XR24 ručkica

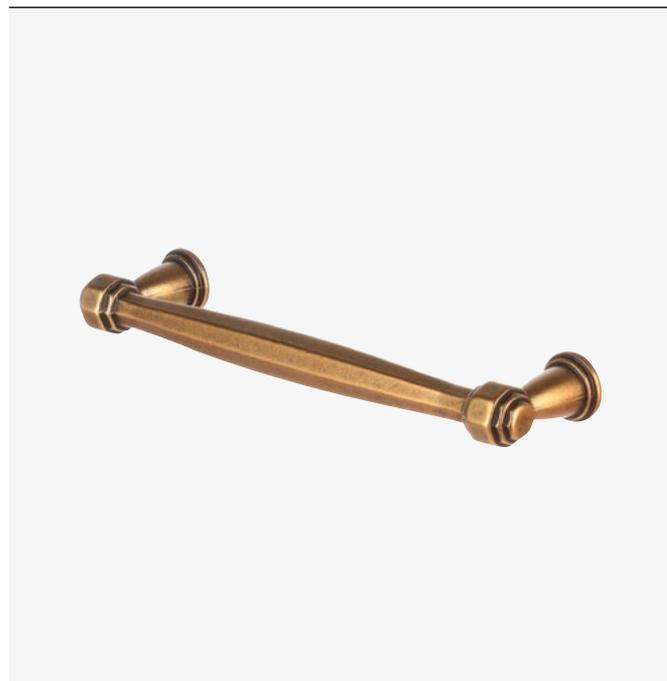

● Patinirano željezo

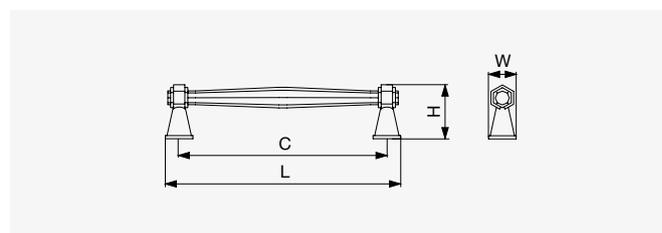

● Francuska bronca

Dimenzija C [mm]	Francuska bronca	Patinirano željezo	Dimenzija L [mm]	Dimenzija H [mm]	Dimenzija W [mm]
128	F003217	F003218	142	34	17

● Citterio Giulio XR24 ručkica

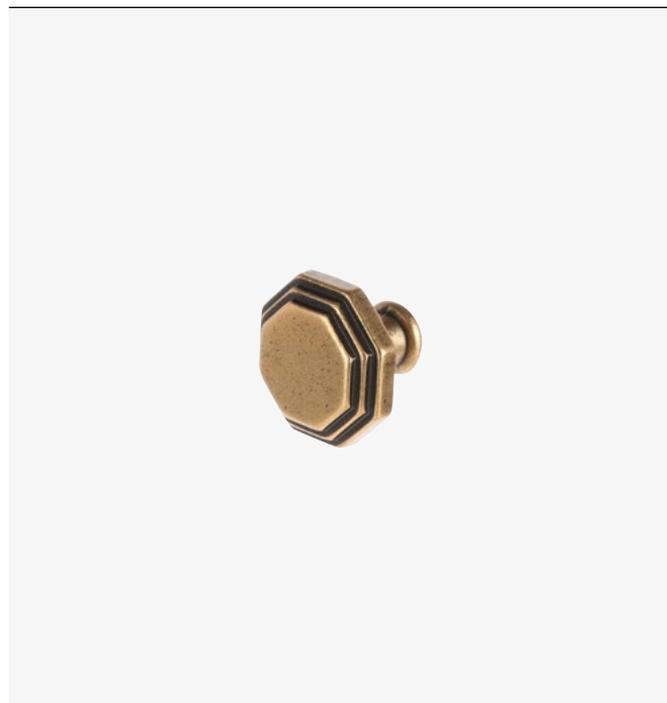

● Patinirano željezo

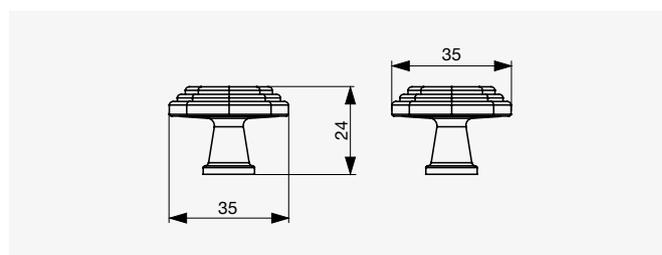

● Francuska bronca

Francuska bronca	Patinirano željezo
F003219	F003220

01  
02  
03  
04  
05  
06  
07  
08  
09  
10  
11  
12  
13  
14  
15  
16  
17  
18

04

● Citterio Giulio XH53 ručkica

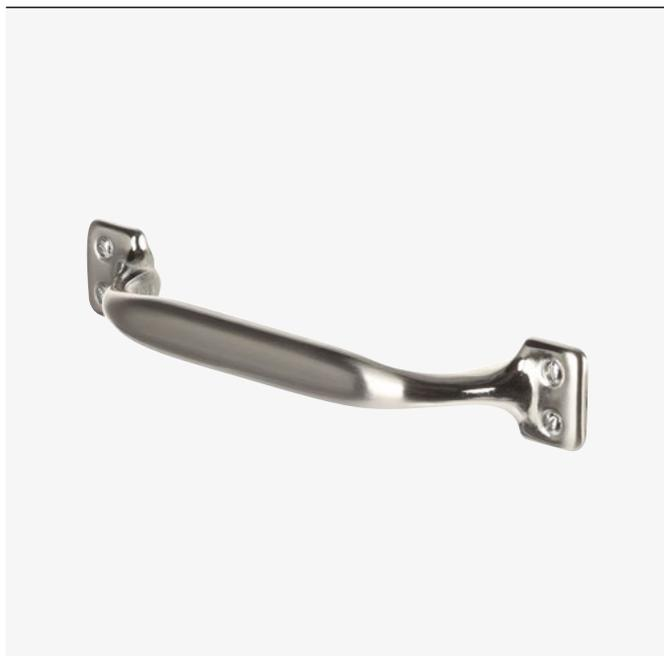

● Polirana francuska bronca

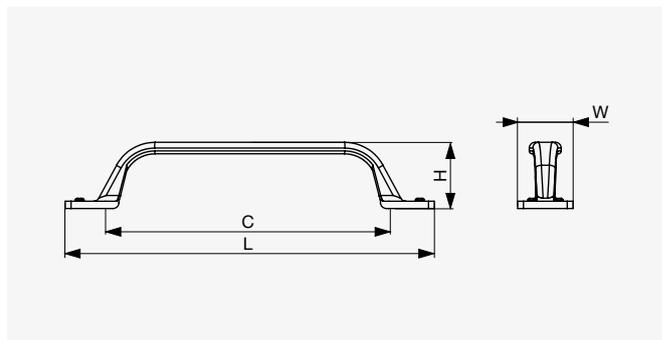

● Mat nikal

Dimenzija C [mm]	Mat nikal	Polirana francuska bronca	Dimenzija L [mm]	Dimenzija H [mm]	Dimenzija W [mm]
64	F003190	F003191	96	23	19
96	F003192	F003193	128		

● Citterio Giulio XR25 ručkica



● Prirodna bronca

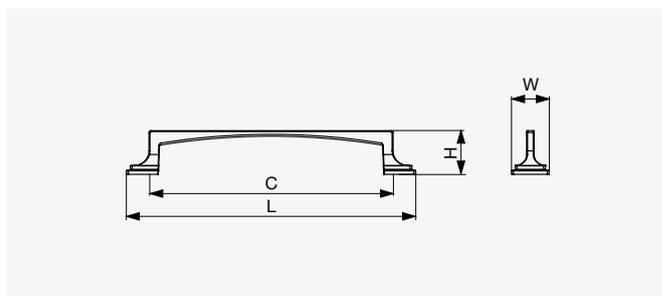

● Patinirano željezo

Dimenzija C [mm]	Patinirano željezo	Prirodna bronca	Dimenzija L [mm]	Dimenzija H [mm]	Dimenzija W [mm]
96	F003222	F003221	123	24	20
128	F003224	F003223	154		

● Citterio Giulio XR30 ručkica

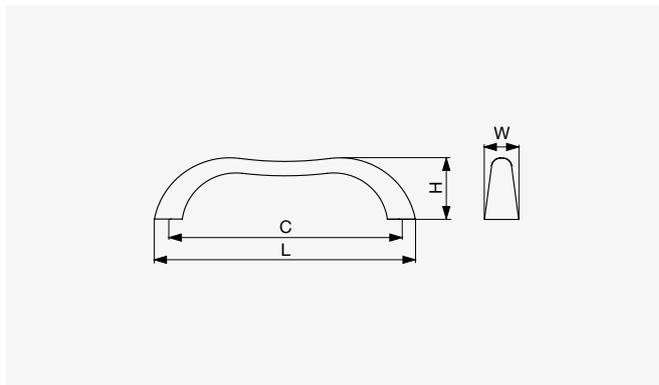

● Polirana brušena bronca

Dimenzija C [mm]	Polirana brušena bronca	Dimenzija L [mm]	Dimenzija H [mm]	Dimenzija W [mm]
96	F003245	107	26	14

● Citterio Giulio XR30 ručkica

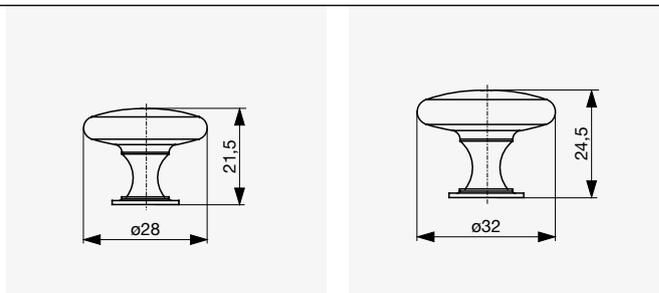
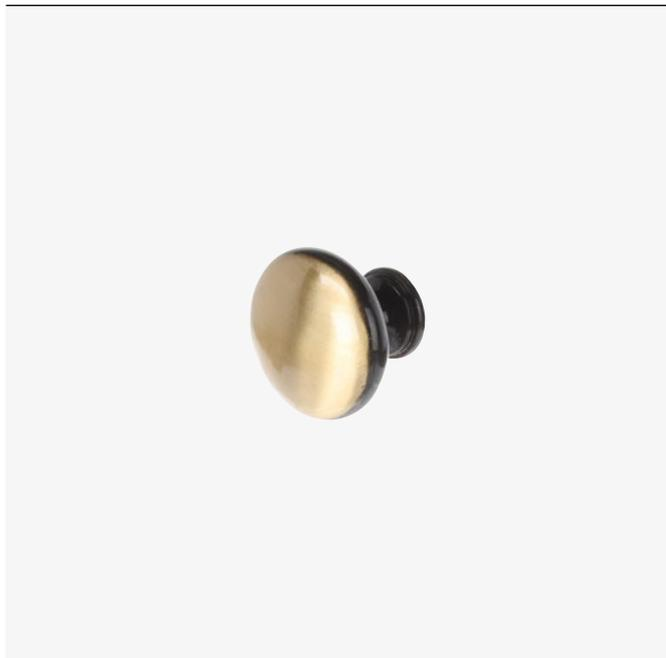

Ⓞ F003251

Ⓞ F003250

● Polirana brušena bronca

Veličina	Polirano četkano
Mala	F003251
Veliki	F003250

01  
02  
03  
04  
05  
06  
07  
08  
09  
10  
11  
12  
13  
14  
15  
16  
17  
18

04

● Citterio Giulio XR30 Pribor, ključ za ruckicu

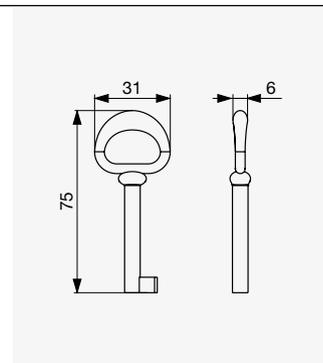
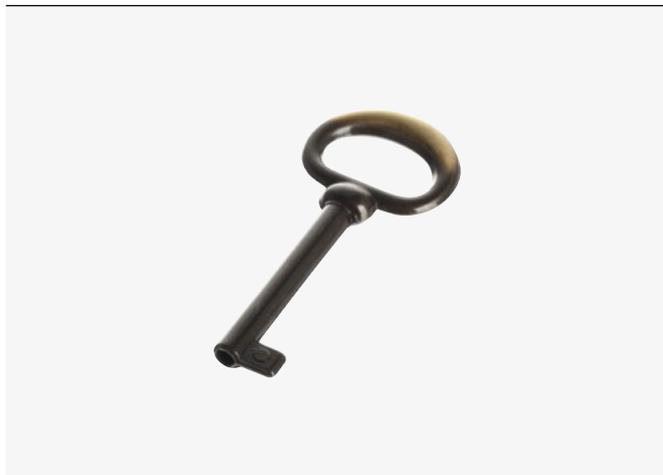

Ključ za ručku

F003246

● Dodatna oprema Citterio Giulio XR30, maska ključa

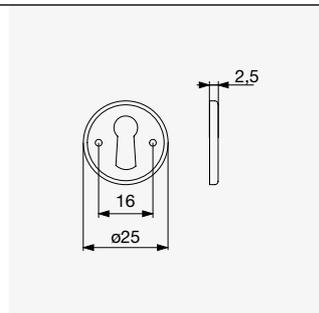

① F003247

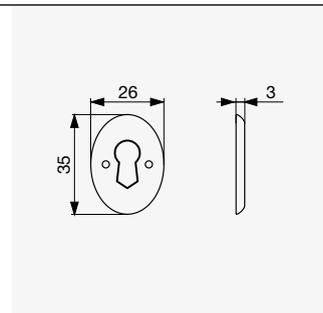

① F003248

Štitnik ključa s udubljenom ruckicom

F003247

Štit za ključ za ruckicu

F003248

① F003247

① F003248

● Citterio Giulio XR30 Dodaci, ručkica

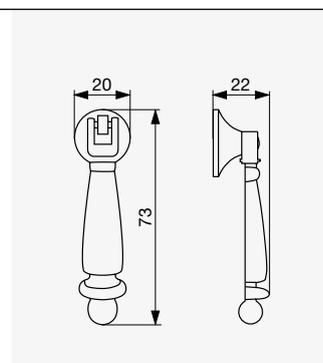

Ruckica

F003249

## ● Citterio Giulio XR32 ručkica

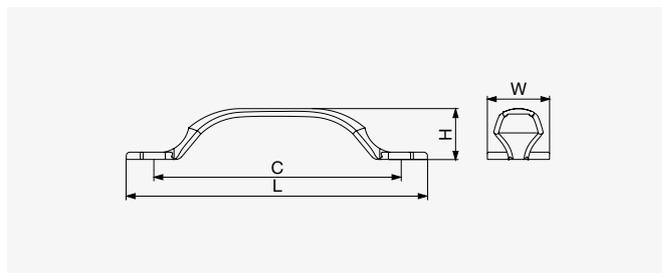
● Patinirano  
željezo

● Prirodna bronca

Dimenzija C [mm]	Prirodna bronca	Patinirano željezo	Dimenzija L [mm]	Dimenzija H [mm]	Dimenzija W [mm]
96	F003260	F003261	123	21	25

## ● Citterio Giulio XR23 ručkica

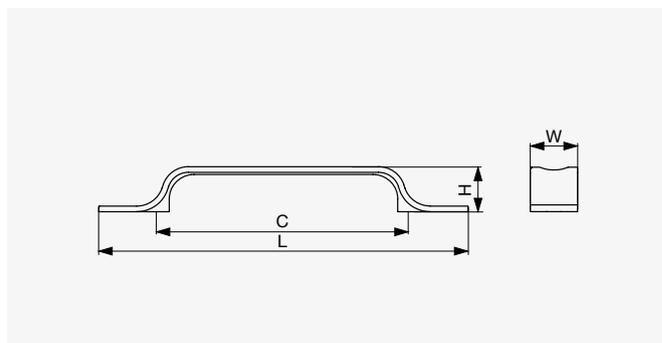
● Patinirano  
željezo

● Prirodna bronca

Dimenzija C [mm]	Prirodna bronca	Patinirano željezo	Dimenzija L [mm]	Dimenzija H [mm]	Dimenzija W [mm]
128	F003213	F003214	194	24	25

04

● Citterio Giulio XR16 ručkica



● Polirano krom

Kuka istog dizajna na str. 4.90.

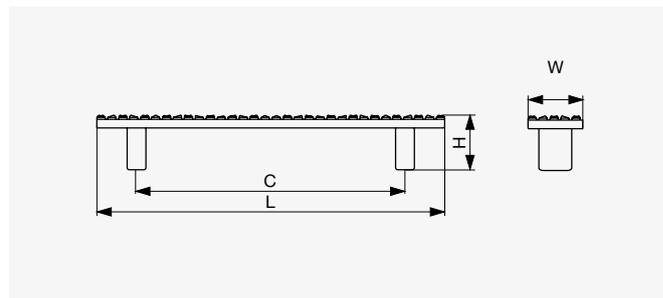

● Polirana francuska bronca

Dimenzija C [mm]	Polirana francuska bronca	Poliran krom	Dimenzija L [mm]	Dimenzija H [mm]	Dimenzija W [mm]
128	F003179	F003178	166		
160	F003181	F003180	198	25	25
320	F003183	F003182	358		

● Citterio Giulio XR16 ručkica



● Polirano krom

Vješalica istog dizajna na str. 4.90.

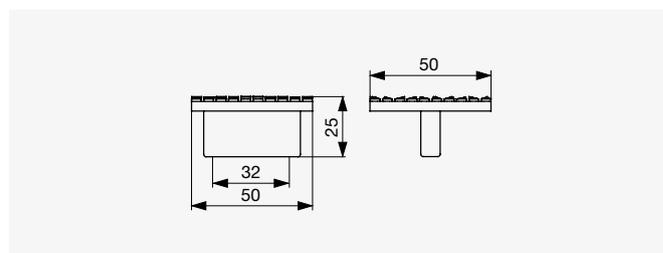

● Polirana francuska bronca

Polirana francuska bronca	Polirano krom	Oblik
F003185	F003184	Kvadrat

## ● Citterio Giulio XR16 ručkica

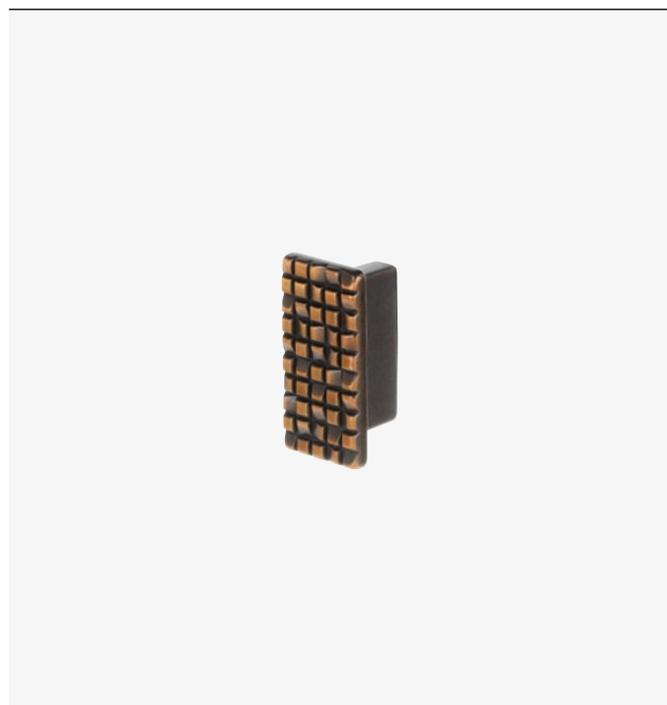

● Polirano krom

Vješalica istog dizajna na str. 4.90.

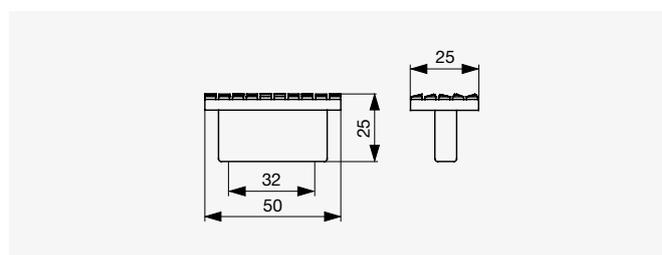

● Polirana francuska bronca

Polirana francuska  
bronca

F003187

Polirano  
krom

F003186

Oblik

Pravokutnik

## ● Citterio Giulio XR16 ručkica

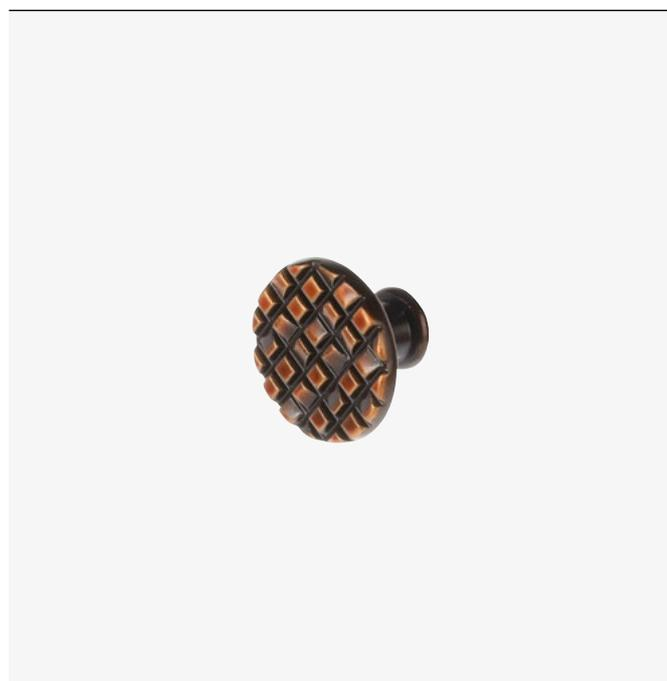

● Polirano krom

Kuka istog dizajna na str. 4.90.

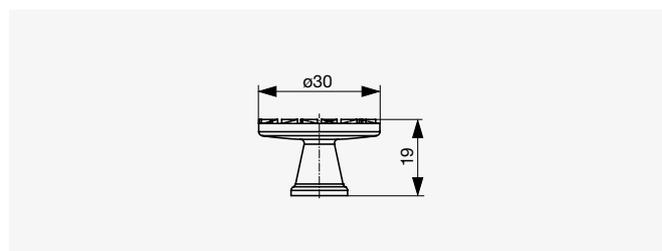

● Polirana francuska bronca

Polirana francuska  
bronca

F003189

Polirano  
krom

F003188

Oblik

Okrugla strana

04

### ● Citterio Giulio XR04 ručkica



- Polirano krom
- Mat brušena bronca

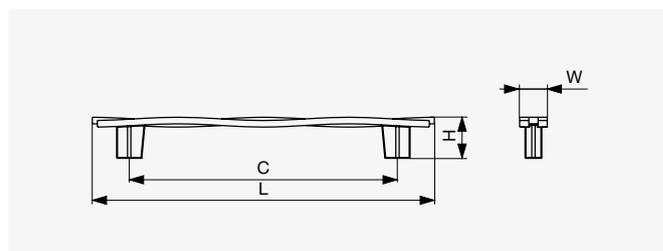

● Patinirano željezo

Dimenzija C [mm]	Patinirano željezo	Polirano krom	Mat brušena bronca	Dimenzija L [mm]	Dimenzija H [mm]	Dimenzija W [mm]
160	F003134	F003132	F003133	204	25	16,5
320	F003137	F003135	F003136	364		

### ● Citterio Giulio XR05 ručkica



- Prirodna bronca

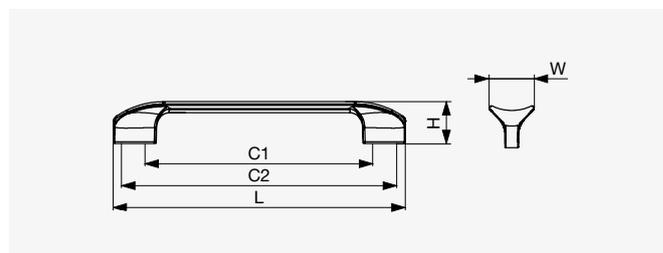

● Patinirano željezo

Dimension C1 / C2 [mm]	Patinirano željezo	Prirodna bronca	Dimenzija L [mm]	Dimenzija H [mm]	Dimenzija W [mm]
64 / 96	F003139	F003138	106	24	26
128 / 160	F003141	F003140	170		
192 / 224	F003143	F003142	234		
320 / 352	F003145	F003144	362		



## ● Citterio Giulio XR15 ručkica



● Prirodna bronca

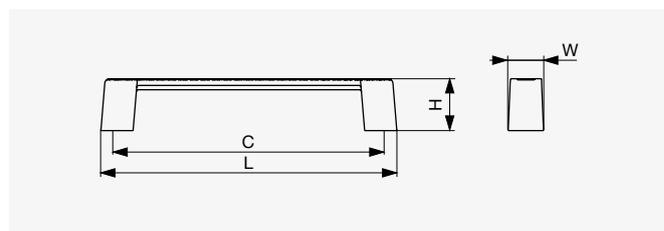

● Patinirano željezo

Dimenzija C [mm]	Patinirano željezo	Prirodna bronca	Dimenzija L [mm]	Dimenzija H [mm]	Dimenzija W [mm]
128	F003147	F003146	138	24	16,5
160	F003149	F003148	170		
192	F003151	F003150	202		
320	F003153	F003152	330		

## ● Citterio Giulio XH48 ručkica



● Mat crna



● Mat zlatna

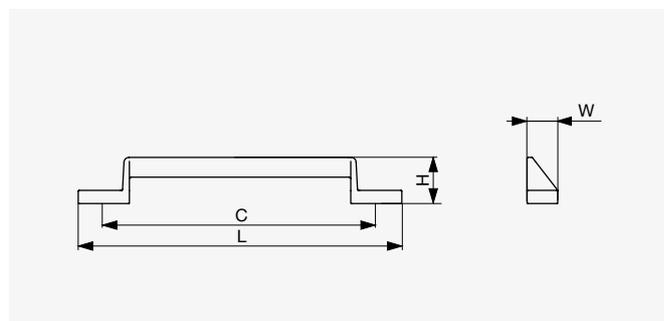

● Mat srebro

Dimenzija C [mm]	Mat srebro	Mat crna	Mat zlatna	Dimenzija L [mm]	Dimenzija H [mm]	Dimenzija W [mm]
96	F003125	F003123	F003124	126	28	18
160	F003128	F003126	F003127	190		
320	F003131	F003129	F003130	350		

04

● Citterio Giulio XR27 ručkica



● Patinirano željezo

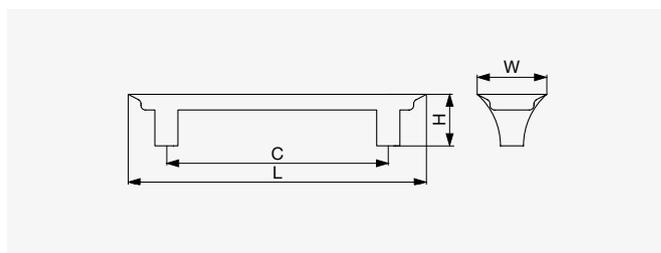

● Francuska bronca

Dimenzija C [mm]	Francuska bronca	Patinirano željezo	Dimenzija L [mm]	Dimenzija H [mm]	Dimenzija W [mm]
96	F003231	F003232	129	23	30

● Citterio Giulio XR27 ručkica



● Patinirano željezo

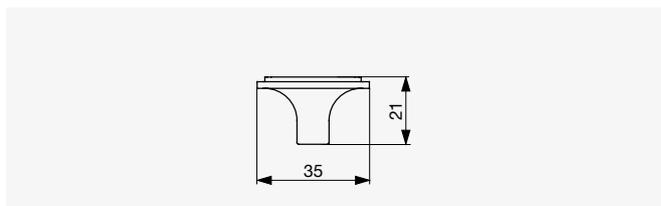

● Francuska bronca

Francuska bronca	Patinirano željezo
F003233	F003234

● Citterio Giulio XR26 ručkica



● Polirana  
brušena bronca

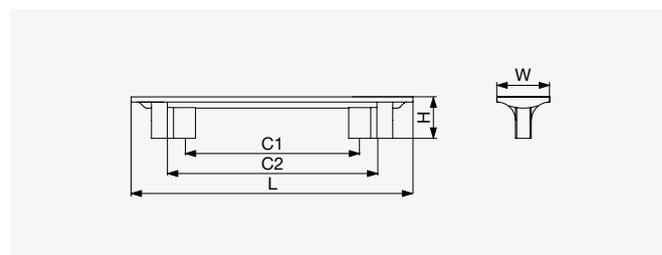

● Patinirano srebro

Dimenzija C1 / C2 [mm]	Patinirano srebro	Polirana brušena bronca	Dimenzija L [mm]	Dimenzija H [mm]	Dimenzija W [mm]
96 / 128	F003226	F003225	160	24	30

● Citterio Giulio XR26 ručkica



● Polirana  
brušena bronca

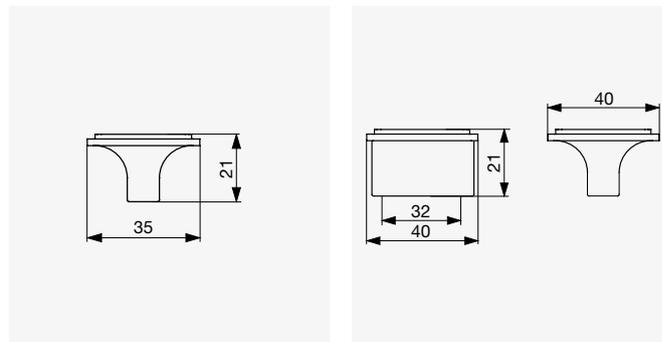

● Patinirano srebro

Dimenzija [mm]	Patinirano srebro	Polirana brušena bronca
35 × 35	F003228	F003227
40 × 40	F003230	F003229

01  
02  
03  
04  
05  
06  
07  
08  
09  
10  
11  
12  
13  
14  
15  
16  
17  
18

04

● Citterio Giulio XH51 ručkica



● Mat crna

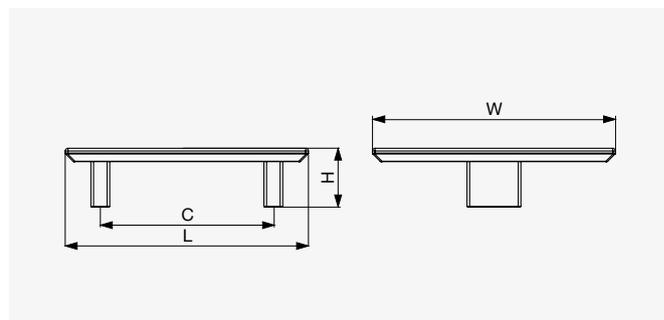

● Brušena tamna bronca

Dimenzija C [mm]	Brušena tamna bronca	Mat crna	Dimenzija L [mm]	Dimenzija H [mm]	Dimenzija W [mm]
64	F003173	F003172	90	22	90

● Citterio Giulio XH50 ručkica



● Mat crna

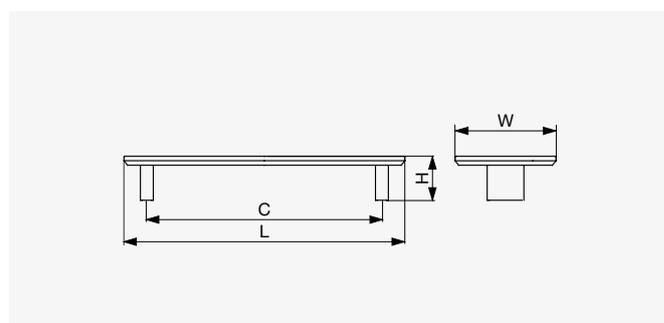

● Brušena tamna bronca

Dimenzija C [mm]	Brušeni tamni bron	Mat crna	Dimenzija L [mm]	Dimenzija H [mm]	Dimenzija W [mm]
96	F003165	F003164	121	24,5	55
128	F003167	F003166	153		
160	F003169	F003168	185		
192	F003171	F003170	217		

### ● Citterio Giulio XZ13 Ugrađena ručkica



● Polirano krom

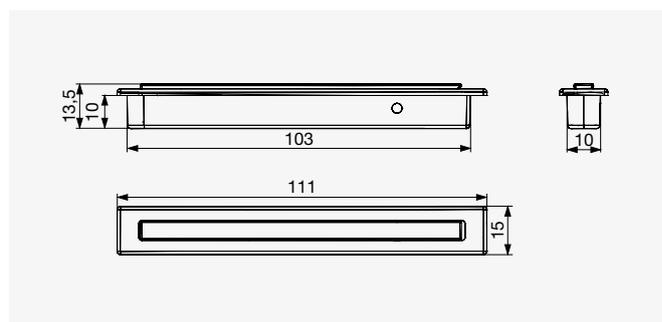

● Mat crna

Polirani  
krom

F003159

Mat  
crna

F003158

### ● Citterio Giulio XK19 ručkica

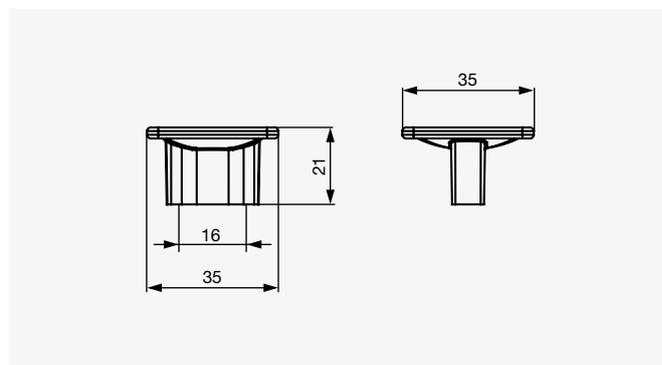
● Patinirano  
željezo

● Prirodna bronca

Prirodna  
bronca

F003215

Patinirano  
željezo

F003216

01  
02  
03  
04  
05  
06  
07  
08  
09  
10  
11  
12  
13  
14  
15  
16  
17  
18

04

### RiexTouch XH01 ručkica



● Mat crna ● Mat krom ● Mat nikal ● Iz nehrdajućeg celika



● Polirano krom

Gumb istog dizajna na str. 4.53.

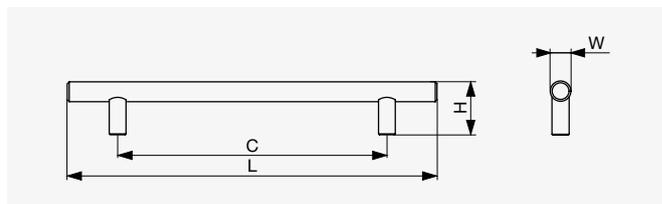

● Brušeni nikal

Dimenzija C [mm]	Brušena nikal	Mat crna	Mat krom	Mat nikal	Iz nehrdajućeg celika	Polirano krom	Dimenzija L [mm]	Dimenzija H [mm]	Dimenzija W [mm]
96	F001584	F001648	F001632	F001600	F001664	F001616	136		
128	F001585	F001649	F001633	F001601	F001665	F001617	168		
160	F001586	F001650	F001634	F001602	F001666	F001618	200		
192	F001587	F001651	F001635	F001603	F001667	F001619	232		
224	F001588	F001652	F001636	F001604	F001668	F001620	264		
256	F001589	F001653	F001637	F001605	F001669	F001621	296		
288	F001590	F001654	F001638	F001606	F001670	F001622	268	32	12
320	F001591	F001655	F001639	F001607	F001671	F001623	360		
384	F001593	F001657	F001641	F001609	F001673	F001625	424		
448	F001595	F001659	F001643	F001611	F001675	F001627	488		
512	F001597	F001661	F001645	F001613	F001677	F001629	552		
576	F001599	F001663	F001647	F001615	F001679	F001631	616		

### RiexTouch XH14 ručkica



● Iz nehrdajućeg celika

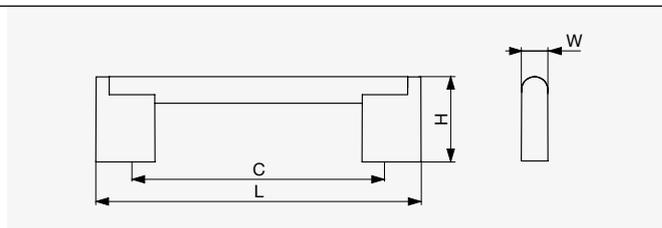

Dimenzija C [mm]	Iz nehrdajućeg celika	Dimenzija L [mm]	Dimenzija H [mm]	Dimenzija W [mm]
128	F002261	153		
160	F002262	185		
192	F002263	217		
224	F002264	249	35	15
256	F002265	281		
320	F002266	345		

## ● RiexTouch XH12 ručnica

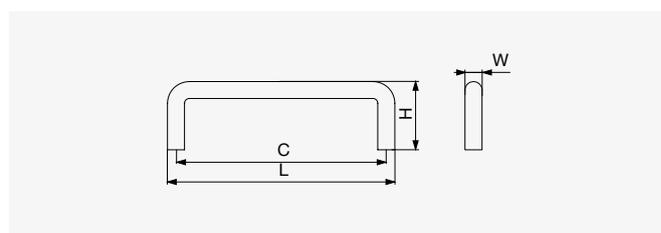
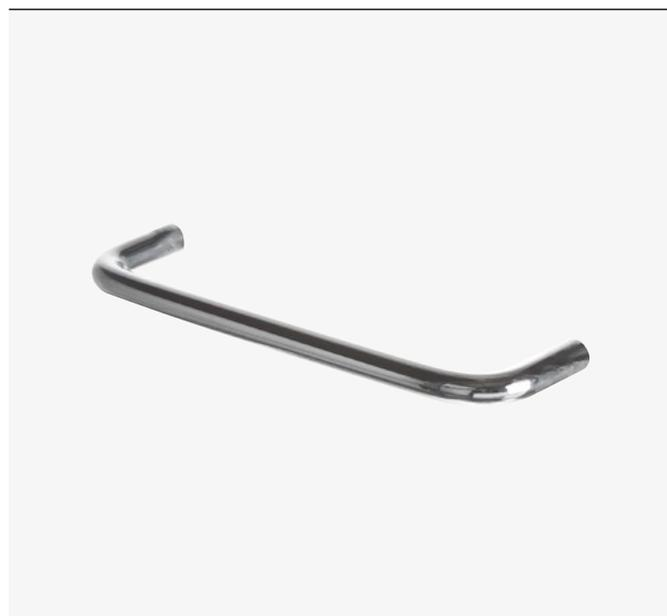

● Polirano krom

Dimenzija C [mm]	Polirano krom	Brušeni nikal	Mat krom	Mat nikal	Dimenzija L [mm]	Dimenzija H [mm]	Dimenzija W [mm]
96	F002820	F002823	F002826	F002829	105	32	8
128	F002821	F002824	F002827	F002830	137		
160	F002822	F002825	F002828	F002831	169		

## ● RiexTouch XH03 ručnica

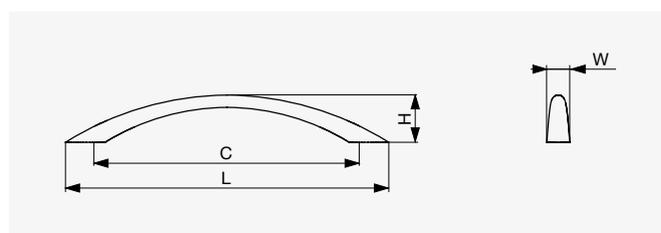
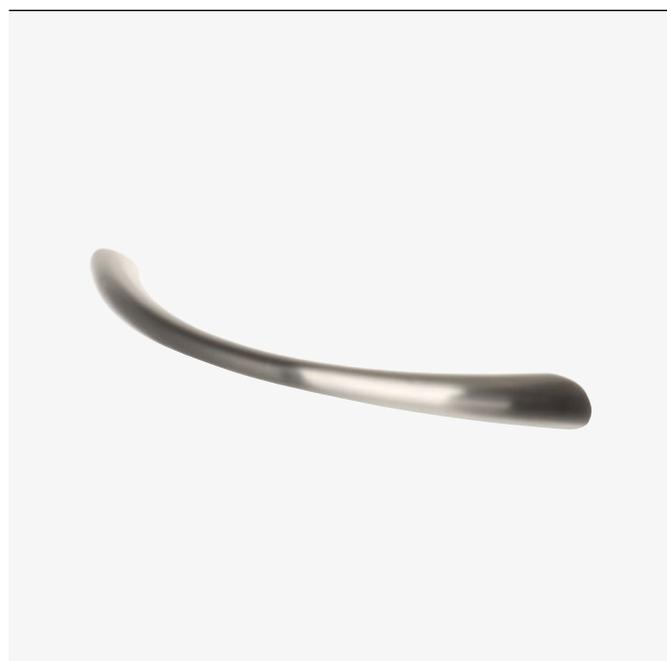

● Mat nikal

Dimenzija C [mm]	Mat nikal	Mat crna	Mat krom	Mat bijela	Poliran zlato	Poliran krom	Imitacija nehrđajućeg čelika	Dimenzija L [mm]	Dimenzija H [mm]	Dimenzija W [mm]
96	F001736	F001740	F001734	F001742	F001738	F001732	F007551	112	27,5	10,5
128	F001737	F001741	F001735	F001743	F001739	F001733	F007552	145	27,5	12

04

### RiexTouch XH05 ručkica

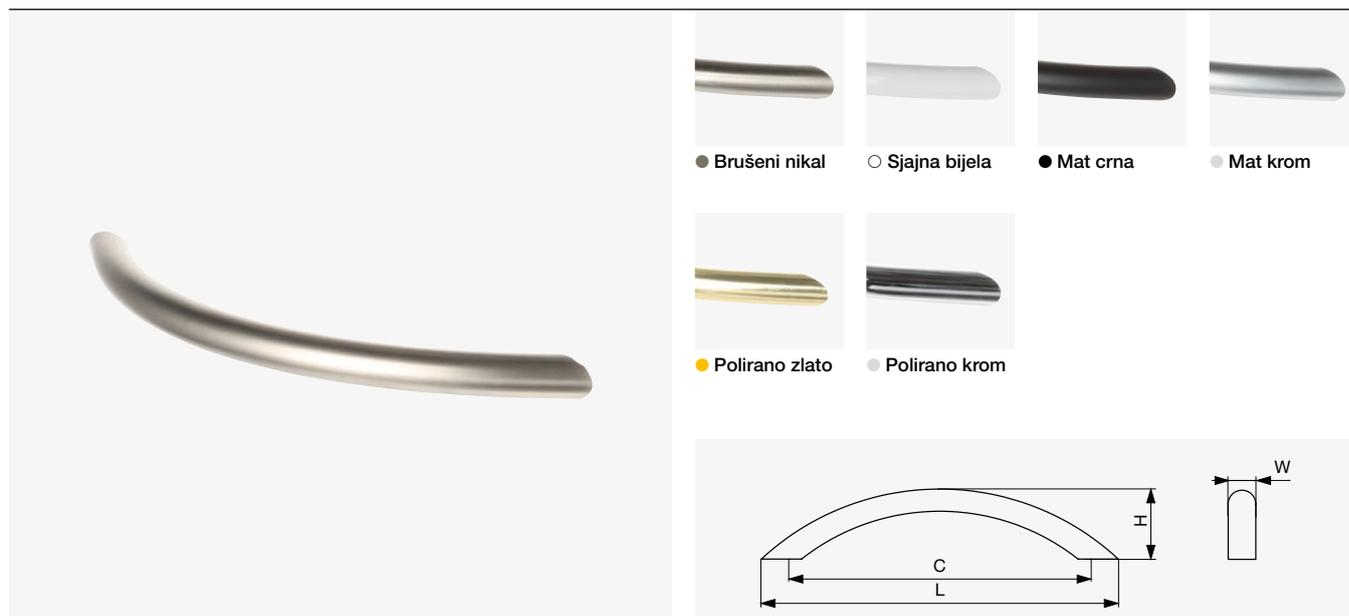

● Mat nikal

Dimenzija C [mm]	Mat nikal	Brušeni nikal	Sjajna bijela	Mat crna	Mat krom	Polirano zlato	Polirano krom	Dimenzija L [mm]	Dimenzija H [mm]	Dimenzija W [mm]
96	F002805	F002808	F002817	F002811	F002799	F002814	F002802	115	30	10
128	F002806	F002809	F002818	F002812	F002800	F002815	F002803	151		
160	F002807	F002810	F002819	F002813	F002801	F002816	F002804	190	32	

### RiexTouch XH10 ručkica

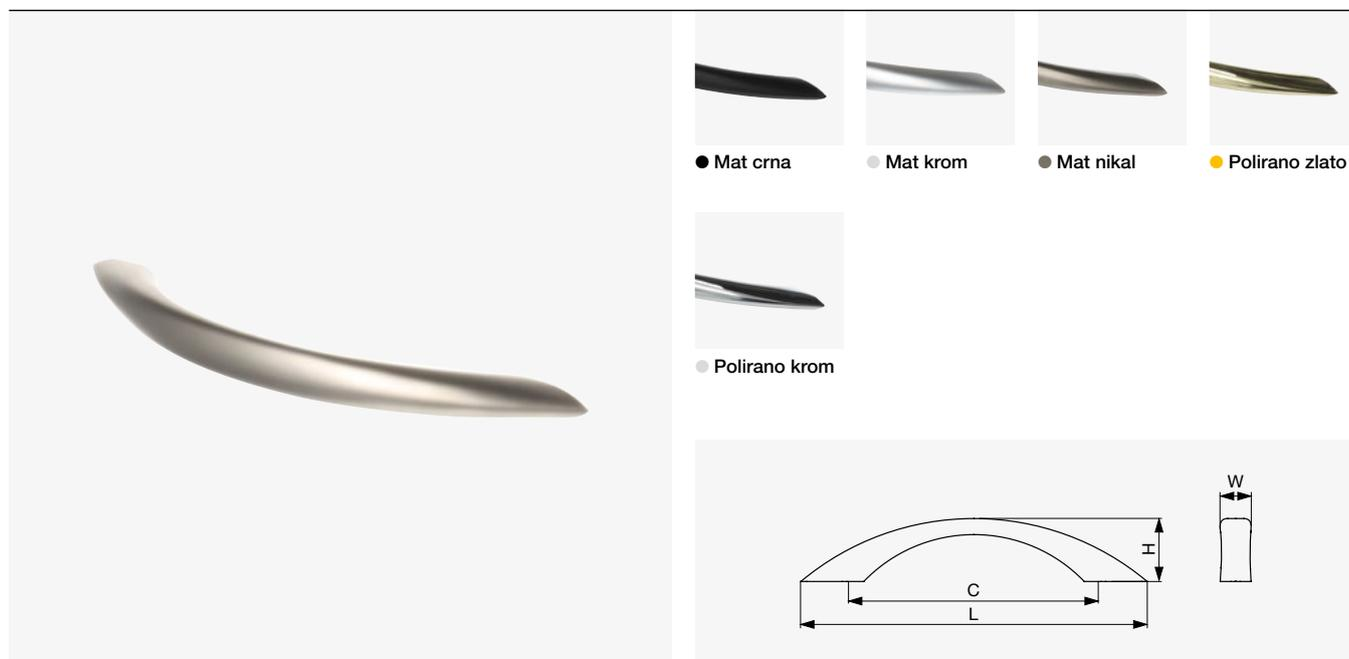

● Brušeni nikal

Dimenzija C [mm]	Brušena nikal	Mat crna	Mat krom	Mat nikal	Polirani zlato	Polirani krom	Dimenzija L [mm]	Dimenzija H [mm]	Dimenzija W [mm]
96	F002335	F002337	F002331	F002333	F002339	F002329	120	23	10
128	F002336	F002338	F002332	F002334	F002340	F002330	152		



## ● RiexTouch XH35 ručnica

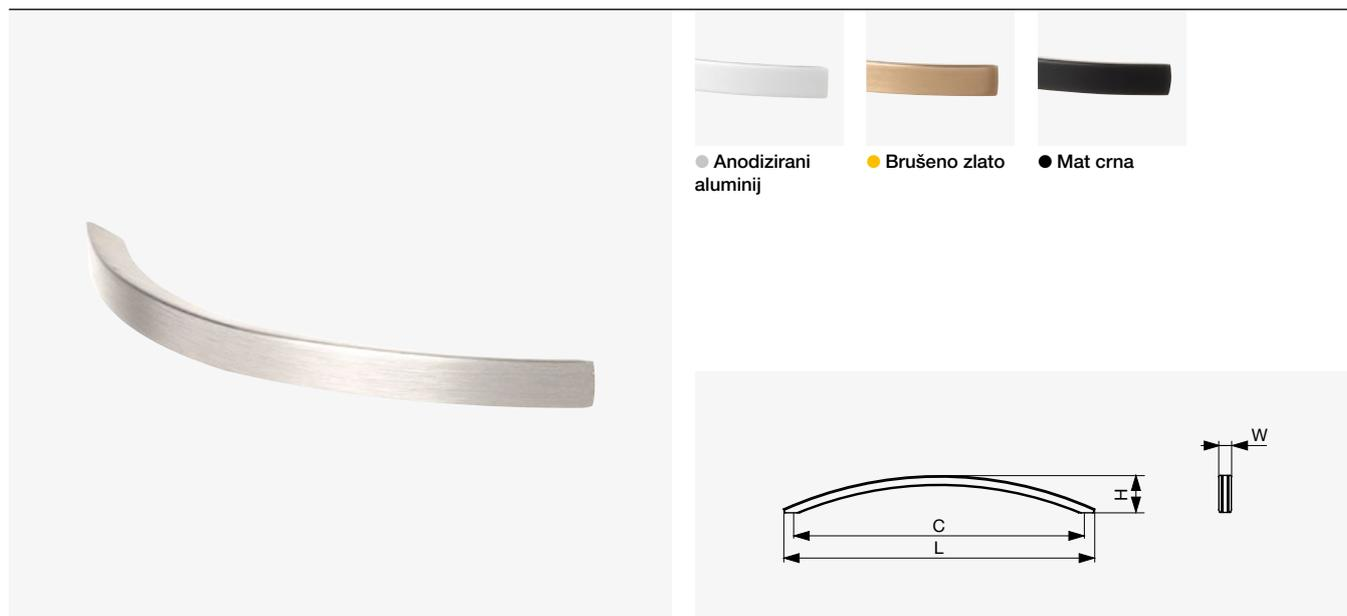

● Imitacija nehrđajućeg čelika

Dimenzija C [mm]	Imitacija nehrđajućeg čelika	Anodizirani aluminij	Polirano zlato	Mat crna	Dimenzija L [mm]	Dimenzija H [mm]	Dimenzija W [mm]
128	F002167	F002158	F002161	F002164	148	34	11
160	F002168	F002159	F002162	F002165	182		
256	F002169	F002160	F002163	F002166	278		

## ● RiexTouch XH44 ručnica

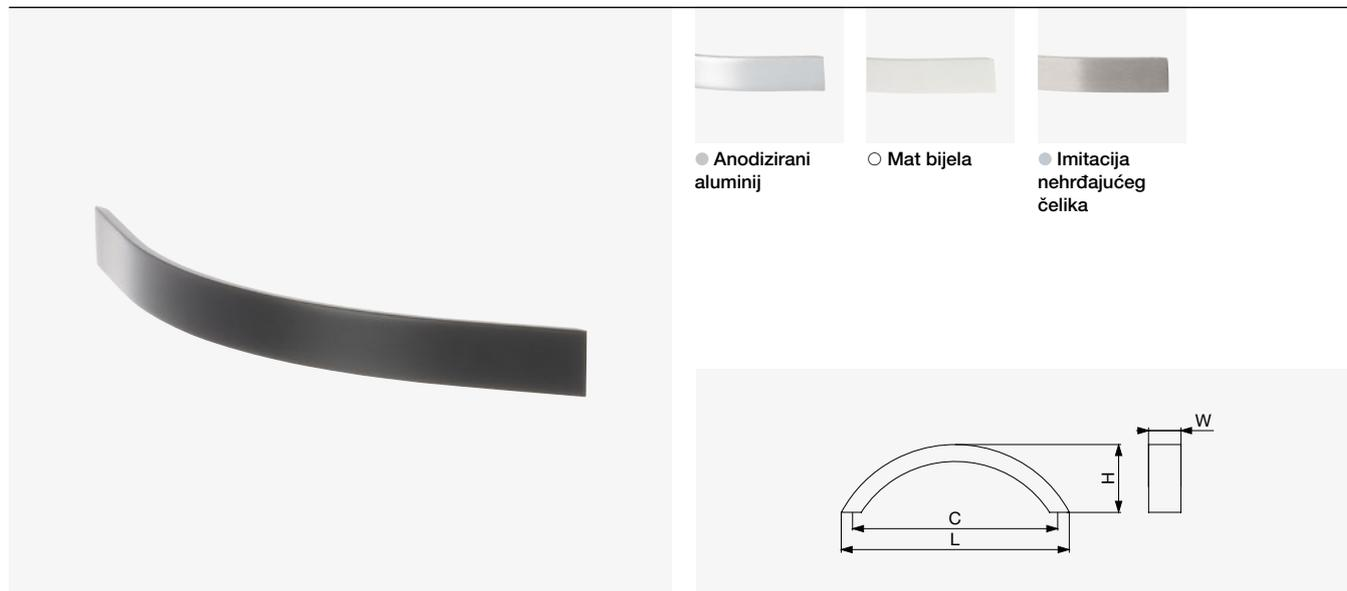

● Mat crna

Dimenzija C [mm]	Mat crna	Anodizirano aluminij	Mat bijela	imitacija nehrđajućeg čelika	Dimenzija L [mm]	Dimenzija H [mm]	Dimenzija W [mm]
96	F002390	F002382	F002394	F002386	126	25	15
128	F002391	F002383	F002395	F002387	158	29	
160	F002392	F002384	F002396	F002388	190	31	
192	F002393	F002385	F002397	F002389	222		

04

### ○ RiexTouch XH19 ručkica

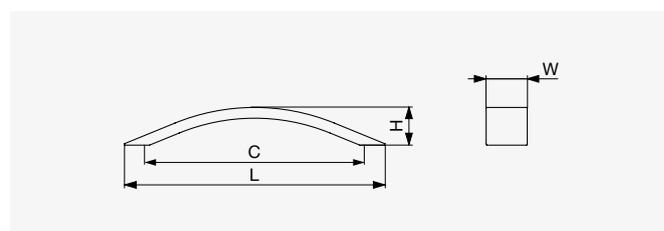
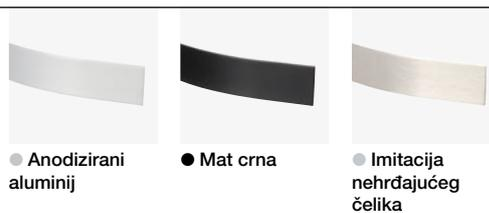

○ Mat bijela

Dimenzija C [mm]	Mat bijela	Anodizirano aluminij	Mat crna	imitacija nehrđajućeg čelika	Dimenzija L [mm]	Dimenzija H [mm]	Dimenzija W [mm]
128	F002349	F002345	F002353	F002341	150	28	30
160	F002350	F002346	F002354	F002342	190		
224	F002351	F002347	F002355	F002343	260	33	
320	F002352	F002348	F002356	F002344	356		

### ● Patinirana smeđa RiexTouch XH43 ručkica

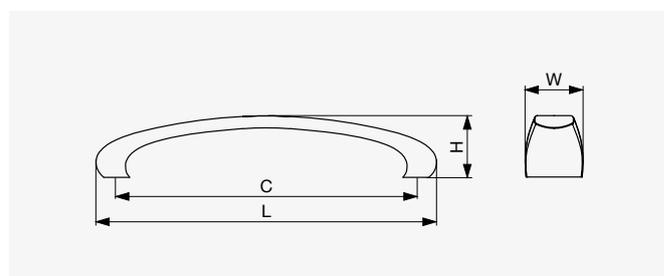

● Patinirana smeđa

Dimenzija C [mm]	Patinirana smeđa	Patinirana bronca	Dimenzija L [mm]	Dimenzija H [mm]	Dimenzija W [mm]
128	F002596	F002598	145	27	25
160	F002597	F002599	177		

## ● RiexTouch XH08 ručnica

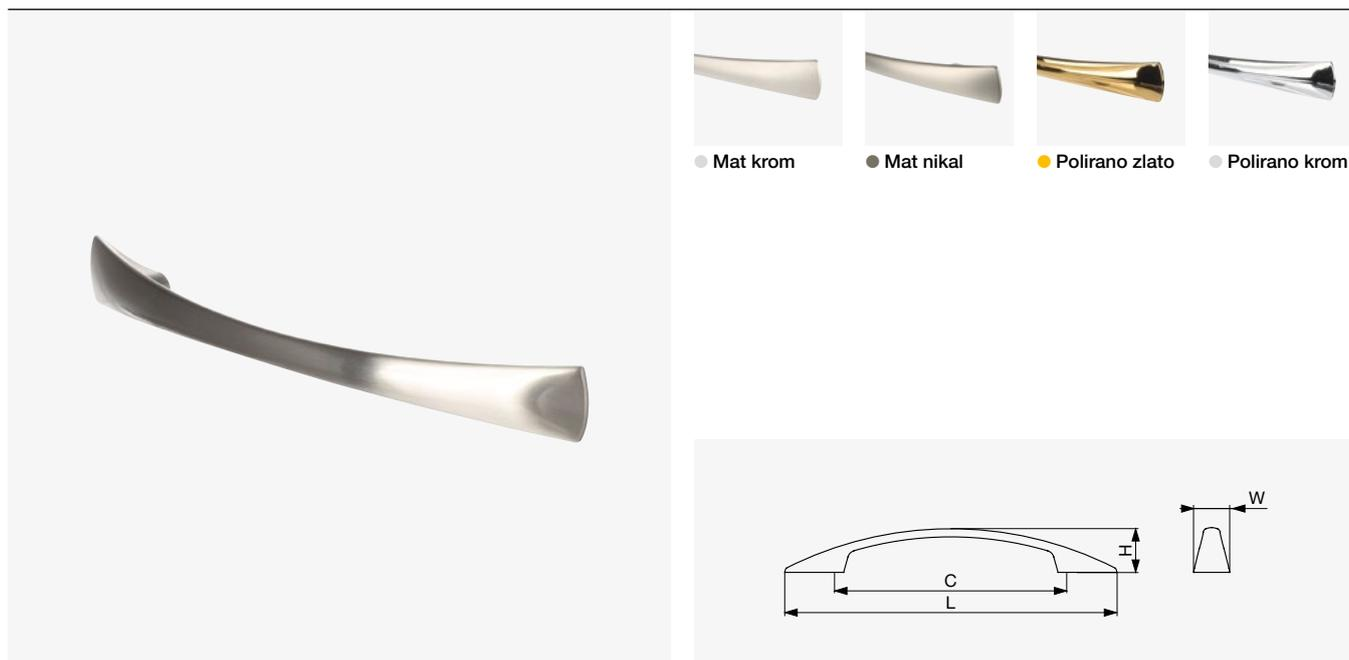

● Brušeni nikal

Dimenzija C [mm]	Brušeni nikal	Mat krom	Mat nikal	Polirano zlato	Polirano krom	Dimenzija L [mm]	Dimenzija H [mm]	Dimenzija W [mm]
96	F002232	F002226	F002228	F002230	F002224	154	23	21
128	F002233	F002227	F002229	F002231	F002225	186		

## ● RiexTouch XH45 ručnica

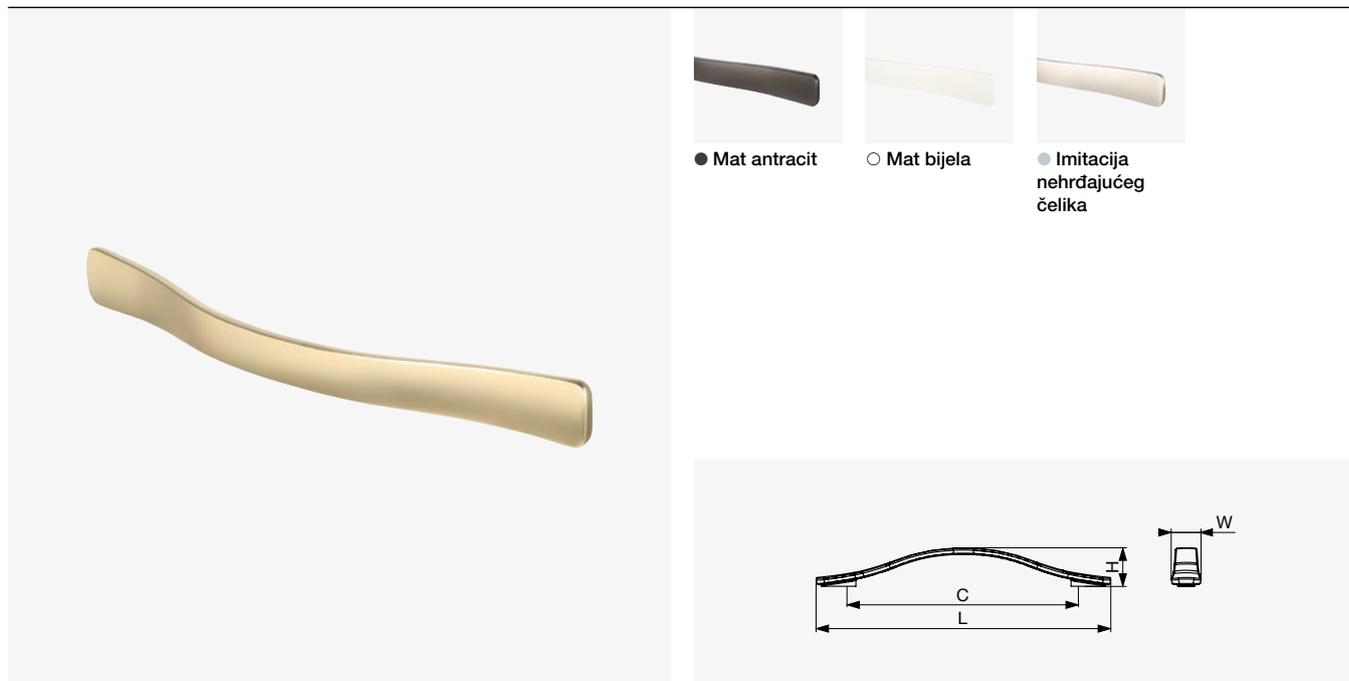

● Mat zlatna

Dimenzija C [mm]	Mat zlatna	Mat antracit	Mat bijela	Imitacija nehrđajućeg čelika	Dimenzija L [mm]	Dimenzija H [mm]	Dimenzija W [mm]
160	F002741	F002743	F002740	F002742	205	27,5	21

01  
02  
03  
04  
05  
06  
07  
08  
09  
10  
11  
12  
13  
14  
15  
16  
17  
18

04

### RiexTouch XH36 ručkica



● Mat nikal ● Polirano zlato ● Polirano krom

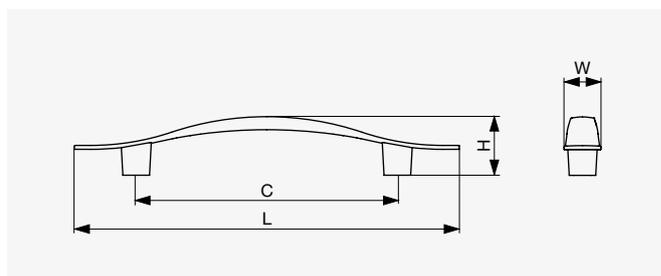

● Mat krom

Dimenzija C [mm]	Mat krom	Mat nikal	Poliran zlato	Poliran krom	Dimenzija L [mm]	Dimenzija H [mm]	Dimenzija W [mm]
96	F001894	F001891	F001893	F001892	142	22	14

### RiexTouch XH40 ručkica



● Mat krom ● Mat nikal ● Polirano krom

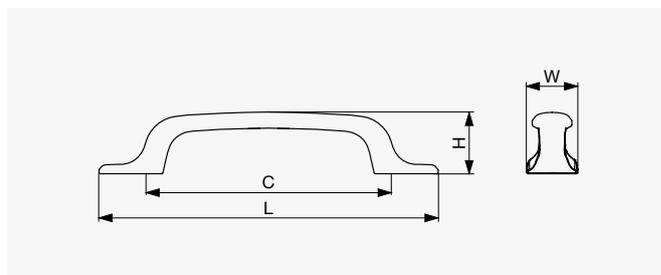

● Mat crna

Dimenzija C [mm]	Mat crna	Mat krom	Mat nikal	Poliran krom	Dimenzija L [mm]	Dimenzija H [mm]	Dimenzija W [mm]
96	F002777	F002771	F002773	F002775	133	25	20
128	F002778	F002772	F002774	F002776	165		

## ● RiexTouch XH47 ručnica

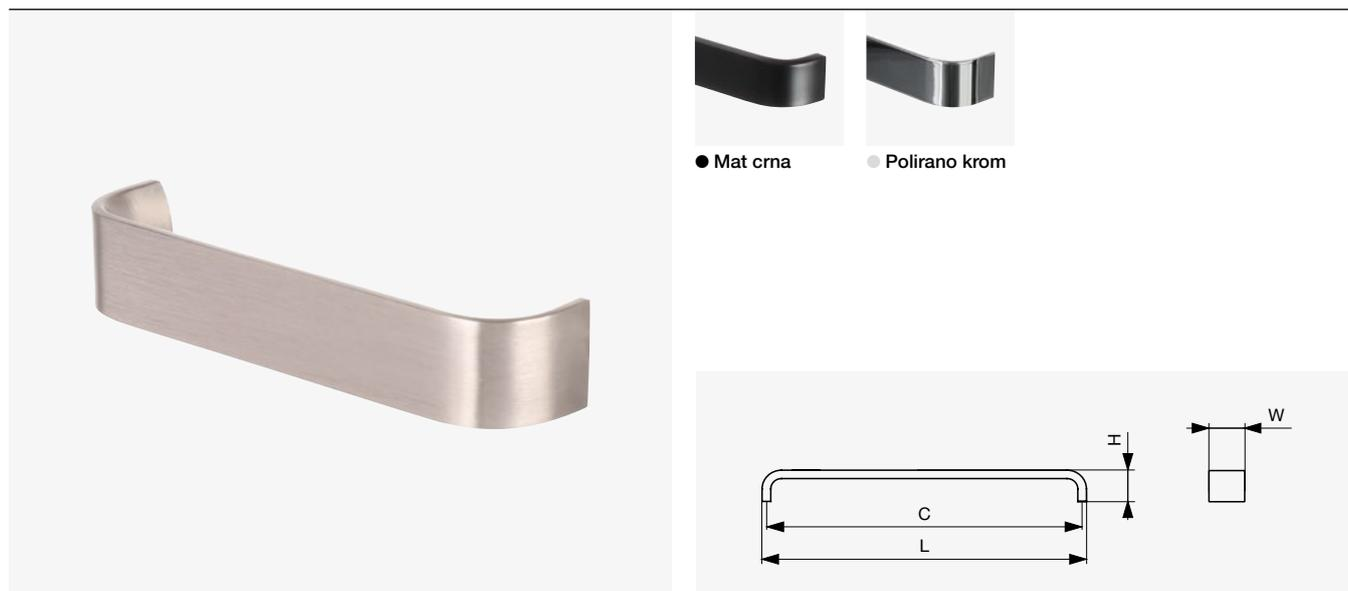

● Imitacija nehrđajućeg čelika

Dimenzija C [mm]	Imitacija nehrđajućeg čelika	Mat crna	Polirani krom	Dimenzija L [mm]	Dimenzija H [mm]	Dimenzija W [mm]
128	F002212	F002220	F002216	136	30	25
160	F002213	F002221	F002217	168		
192	F002214	F002222	F002218	200		
320	F002215	F002223	F002219	328		

## ● RiexTouch XH24 ručnica

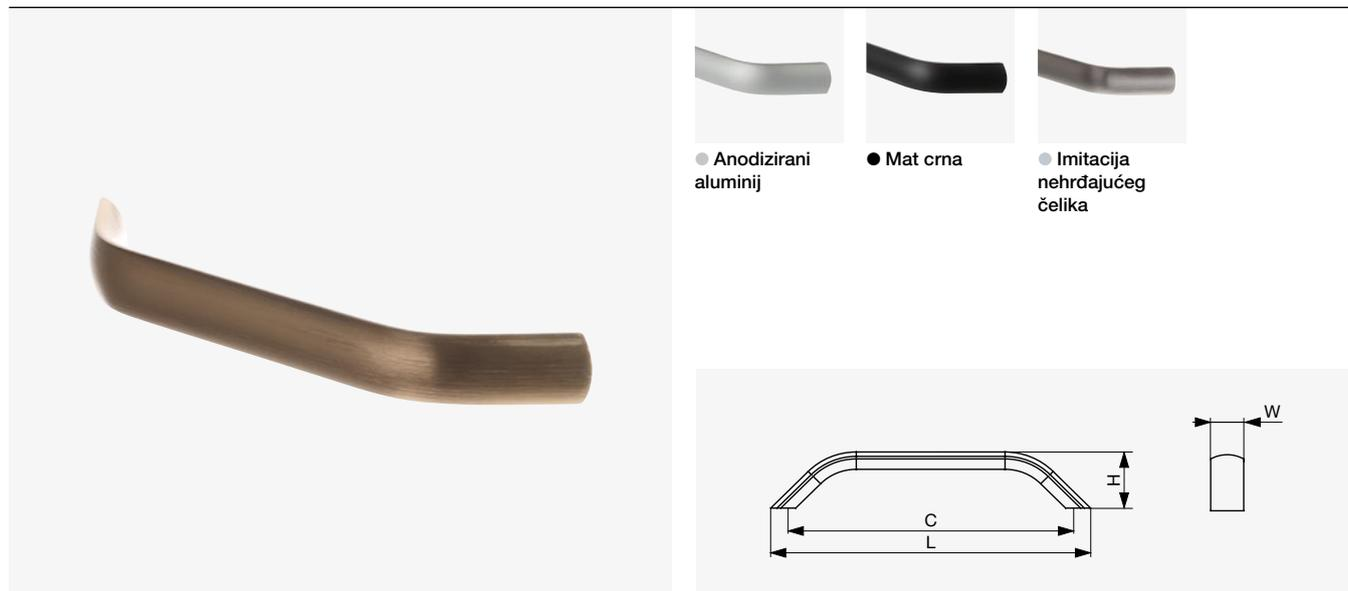

● Brušeno zlato

Dimenzija C [mm]	Brušeno zlato	Anodiziran aluminij	Mat crna	Imitacija nehrđajućeg čelika	Dimenzija L [mm]	Dimenzija H [mm]	Dimenzija W [mm]
128	F001571	F001567	F001563	F001559	135	26	15
160	F001572	F001568	F001564	F001560	177		
224	F001573	F001569	F001565	F001561	241		
320	F001574	F001570	F001566	F001562	337		

04

### RiexTouch XH22 ručkica



- Anodizirani aluminij
- Mat crna
- Imitacija nehrđajućeg čelika

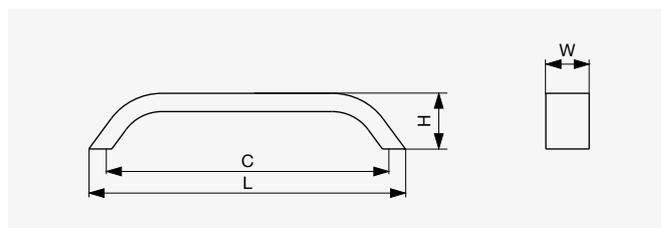

● Mat smeđa

Dimenzija C [mm]	Mat smeđa	Anodizirani aluminij	Mat crna	Imitacija nehrđajućeg čelika	Dimenzija L [mm]	Dimenzija H [mm]	Dimenzija W [mm]
128	F001542	F001532	F001537	F001527	147	32	25
160	F001543	F001533	F001538	F001528	179		
192	F001544	F001534	F001539	F001529	211		
224	F001545	F001535	F001540	F001530	243		
320	F001546	F001536	F001541	F001531	339		

### RiexTouch XH28 ručkica



- Polirani krom / imitacija nehrđajućeg čelika

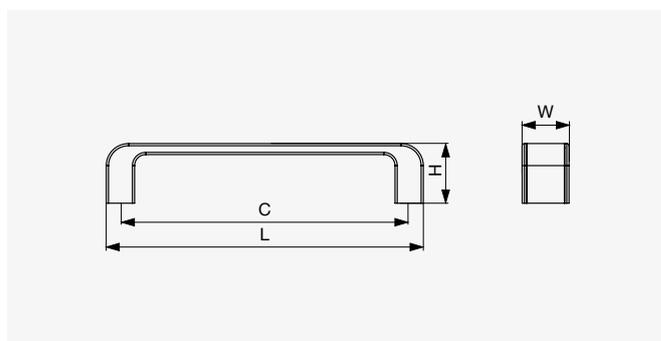

● Polirani krom / mat bijela

Dimenzija C [mm]	Polirani krom / mat bijela	Polirani krom / imitacija nehrđajućeg čelika	Dimenzija L [mm]	Dimenzija H [mm]	Dimenzija W [mm]
128	F001721	F001718	142	27	21
192	F001722	F001719	206		
256	F001723	F001720	270		

## ● RiexTouch XH07 ručica



● Mat krom ● Mat nikal ● Polirano krom

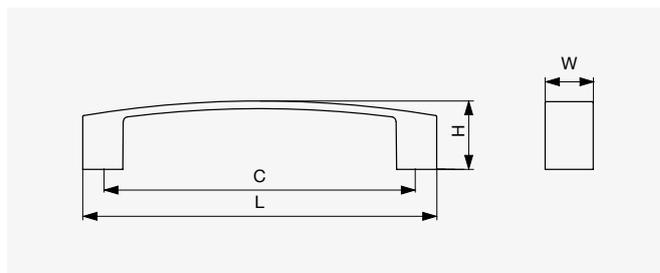

● Imitacija nehrđajućeg čelika

Dimenzija C [mm]	Imitacija nehrđajućeg čelika	Mat krom	Mat nikal	Polirano krom	Dimenzija L [mm]	Dimenzija H [mm]	Dimenzija W [mm]
128	F001762	F001757	F001767	F001772	146	29	20
160	F001763	F001758	F001768	F001773	178		
192	F001764	F001759	F001769	F001774	210		
256	F001765	F001760	F001770	F001775	274		
320	F001766	F001761	F001771	F001776	338		

## ● RiexTouch XH32 ručica



● Mat krom ● Patinirano zlato ● Imitacija nehrđajućeg čelika

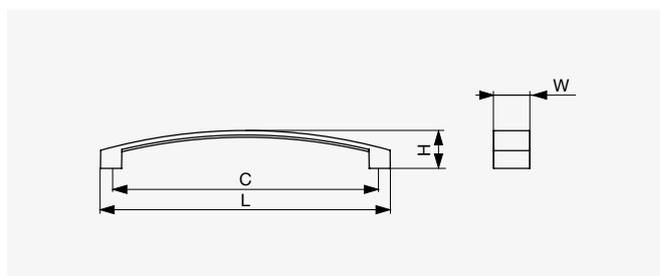

● Patinirana bronca

Dimenzija C [mm]	Patiniran bronast	Mat krom	Patiniran zlato	Imitacija nehrđajućeg čelika	Dimenzija L [mm]	Dimenzija H [mm]	Dimenzija W [mm]
160	F002156	F002152	F002154	F002150	172	23	22
224	F002157	F002153	F002155	F002151	236		

04

### ● RiexTouch XH02 ručkica

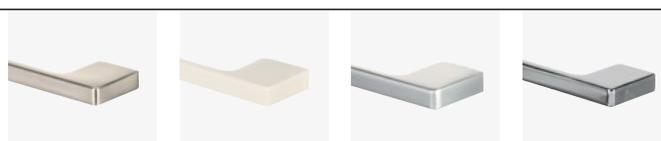

- Brušeni nikal
- Sjajna bijela
- Mat krom
- Polirano krom

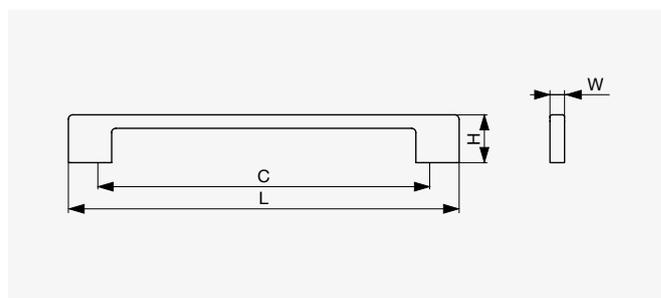

● Mat crna

Dimenzija C [mm]	Mat crna	Brušeni nikal	Sjajna bijela	Mat krom	Polirano krom	Dimenzija L [mm]	Dimenzija H [mm]	Dimenzija W [mm]
96	F001244	F001226	F001250	F001238	F001232	130	28	8,5
128	F001245	F001227	F001251	F001239	F001233	162		
160	F001246	F001228	F001252	F001240	F001234	194		
192	F001247	F001229	F001253	F001241	F001235	226		
256	F001248	F001230	F001254	F001242	F001236	290		
320	F001249	F001231	F001255	F001243	F001237	354		

### ● RiexTouch XH42 ručkica



● Mat zlato

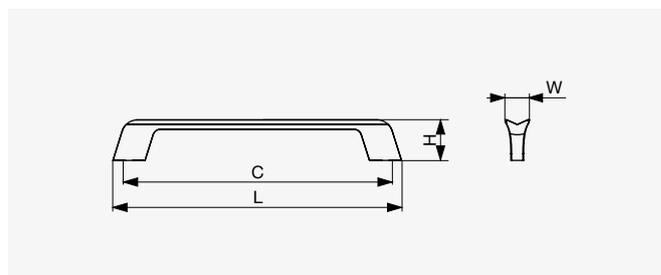

● Brušeni crni nikal

Dimenzija C [mm]	Brušeni crni nikal	Mat zlato	Dimenzija L [mm]	Dimenzija H [mm]	Dimenzija W [mm]
160	F002236	F002238	180	26	15
320	F002237	F002239	340		



## ● RiexTouch XH31 ručnica



● Polirano krom / bijela mat boja

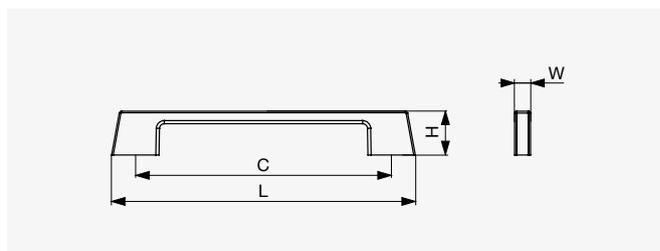

● Polirani krom / antracit

Dimenzija C [mm]	Polirani krom / antracit	Polirani krom / bijela mat boja	Dimenzija L [mm]	Dimenzija H [mm]	Dimenzija W [mm]
96	F001708	F001713	121	28	10
128	F001709	F001714	145		
160	F001710	F001715	190		
224	F001711	F001716	254		
320	F001712	F001717	353		

## ● RiexTouch XH30 ručnica



● Mat krom



● Imitacija nehrđajućeg čelika

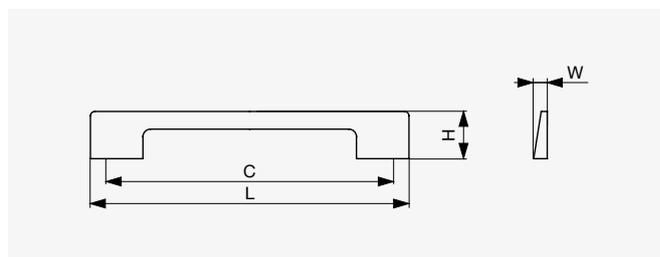

● Polirano krom

Dimenzija C [mm]	Polirani krom	Mat krom	Imitacija nehrđajućeg čelika	Dimenzija L [mm]	Dimenzija H [mm]	Dimenzija W [mm]
160	F002203	F002209	F002206	180	32	9
192	F002204	F002210	F002207	212		
320	F002205	F002211	F002208	340		

04

### ● RiexTouch XH06 ručkica



- Brušeni nikal
- Polirano krom
- Imitacija nehrđajućeg čelika

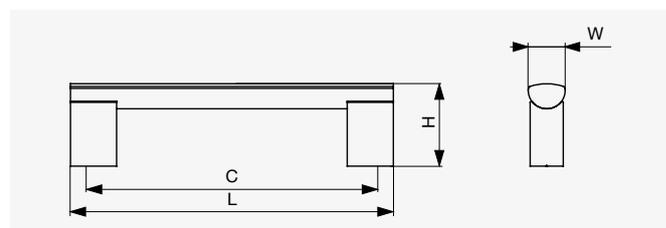

● Anodizirani aluminij

Dimenzija C [mm]	Anodizirano aluminij	Poliran nikal	Poliran krom	Imitacija nehrđajućeg čelika	Dimenzija L [mm]	Dimenzija H [mm]	Dimenzija W [mm]
96	F001256	F001271	F001301	F001286	108	36	16
128	F001257	F001272	F001302	F001287	140		
160	F001258	F001273	F001303	F001288	172		
192	F001259	F001274	F001304	F001289	204		
224	F001260	F001275	F001305	F001290	344		
256	F001261	F001276	F001306	F001291	268		
288	F001262	F001277	F001307	F001292	300		
320	F001263	F001278	F001308	F001293	332		
384	F001264	F001279	F001309	F001294	396		
448	F001265	F001280	F001310	F001295	460		
480	F001266	F001281	F001311	F001296	492		
544	F001267	F001282	F001312	F001297	556		
672	F001268	F001283	F001313	F001298	684		
736	F001269	F001284	F001314	F001299	748		
768	F001270	F001285	F001315	F001300	780		

### ● RiexTouch XH26 ručkica



● Polirano krom

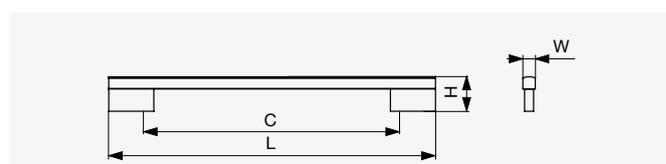

● Imitacija nehrđajućeg čelika

Dimenzija C [mm]	Imitacija nehrđajućeg čelika	Poliran krom	Dimenzija L [mm]	Dimenzija H [mm]	Dimenzija W [mm]
160	F001581	F001578	226	31	11
224	F001582	F001579	290		
320	F001583	F001580	386		

## ● RiexTouch XH23 ručkica



● Polirano krom / bijela mat boja

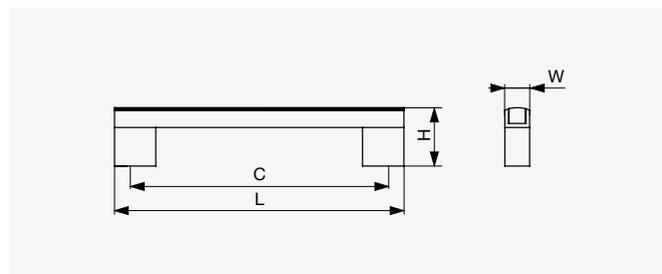

● Polirani krom / imitacija nehrđajućeg čelika

Dimenzija C [mm]	Polirani krom / imitacija nehrđajućeg čelika	Polirani krom / mat bela	Dimenzija L [mm]	Dimenzija H [mm]	Dimenzija W [mm]
128	F001547	F001553	140	29	12
160	F001548	F001554	172		
192	F001549	F001555	204		
224	F001550	F001556	236		
320	F001551	F001557	332		
448	F001552	F001558	460		

## ● RiexTouch XH18 ručkica



● Mat krom / anodizirani aluminij



● Imitacija nehrđajućeg čelika / Imitacija nehrđajućeg čelika

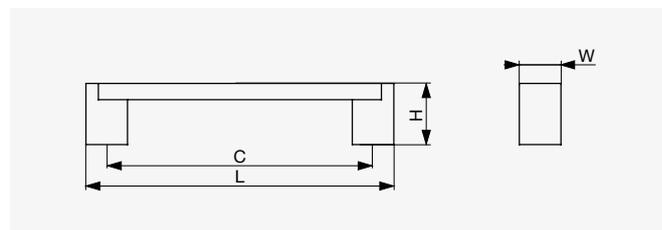

● Polirani krom / imitacija nehrđajućeg čelika

Dimenzija C [mm]	Polirani krom / imitacija nehrđajućeg čelika	Mat krom / anodizirani aluminij	Imitacija nehrđajućeg čelika / Imitacija nehrđajućeg čelika	Dimenzija L [mm]	Dimenzija H [mm]	Dimenzija W [mm]
128	F002565	F002571	F002559	148	30	20
160	F002566	F002572	F002560	180		
224	F002567	F002573	F002561	244		
320	F002568	F002574	F002562	340		
480	F002569	F002575	F002563	500		
544	F002570	F002576	F002564	564		

04

### ● RiexTouch XH25 ručkica

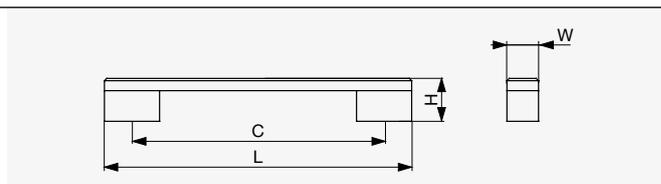

Gumb istog dizajna na str. 4.57.  
Kuka istog dizajna na str. 4.95.

Dimenzija C [mm]	Mat crna	Dimenzija L [mm]	Dimenzija H [mm]	Dimenzija W [mm]
160	F001575	195		
224	F001577	355	28	20
320	F001576	259		

● Mat crna

### ● RiexTouch XH20 ručkica

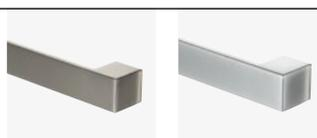

● Brušeni nikal ● Mat krom

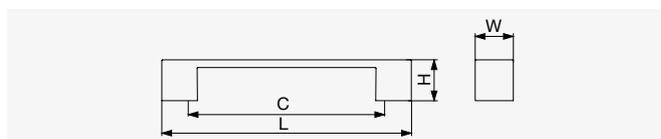

● Patinirani nikal

Dimenzija C [mm]	Patiniran nikal	Brušeni nikal	Mat krom	Dimenzija L [mm]	Dimenzija H [mm]	Dimenzija W [mm]
128	F002581	F002577	F002579	163		
192	F002582	F002578	F002580	228	27	25

### ● RiexTouch XH29 ručkica

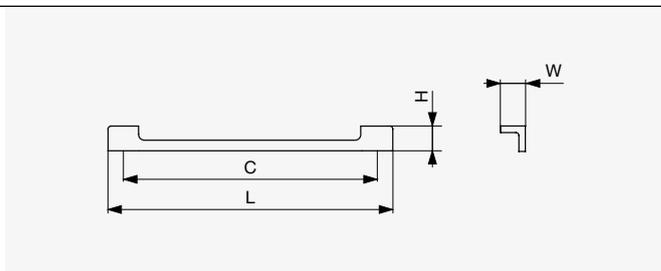

Dimenzija C [mm]	Imitacija nehrđajućeg čelika	Dimenzija L [mm]	Dimenzija H [mm]	Dimenzija W [mm]
192	F002378	220		
288	F002379	310	25	25

● Imitacija nehrđajućeg čelika

## ● RiexTouch XH11 ručkica

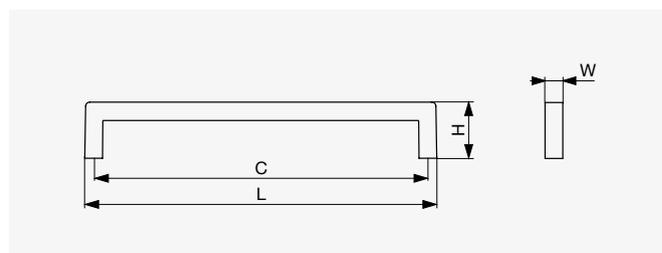

● Mat krom

● Imitacija  
nehrdajućeg  
čelika

● Mat crna

Dimenzija C [mm]	Mat crna	Mat krom	Imitacija nehrdajućeg čelika	Dimenzija L [mm]	Dimenzija H [mm]	Dimenzija W [mm]
96	F002182	F002176	F002170	105		
128	F002183	F002177	F002171	137		
160	F002184	F002178	F002172	169		
192	F002185	F002179	F002173	201	28	8
320	F002186	F002180	F002174	329		
448	F002187	F002181	F002175	457		

## ● RiexTouch XH16 ručkica



● Mat crna

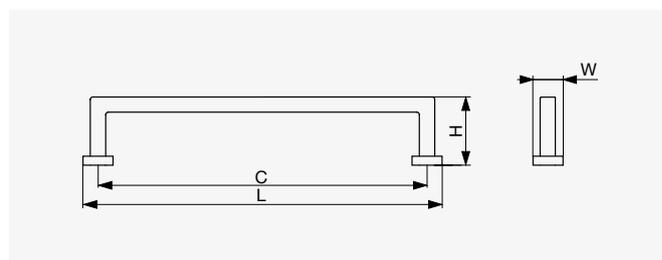

● Polirano krom

Dimenzija C [mm]	Polirani krom	Mat crna	Dimenzija L [mm]	Dimenzija H [mm]	Dimenzija W [mm]
128	F001728	F001724	137		
160	F001729	F001725	169	28	9
192	F001730	F001726	201		

04

### RiexTouch XH13 ručkica

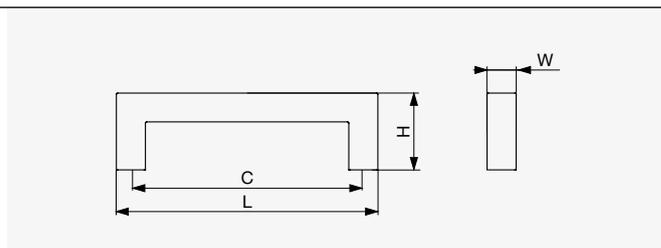

● Brušeno nerjavno jeklo

Dimenzija C [mm]	Brušena iz nerjavnečega jekla	Dimenzija L [mm]	Dimenzija H [mm]	Dimenzija W [mm]
128	F002188	140	32	12
160	F002189	172		
224	F002190	236		
320	F002191	332		
448	F002192	460		

### RiexTouch XR19 ručkica

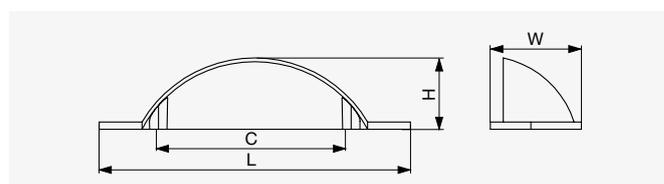

● Patinirana smeđa

Dimenzija C [mm]	Patinirano smeđa	Mat crna	Patinirano zlato	Patinirano kositar	Dimenzija L [mm]	Dimenzija H [mm]	Dimenzija W [mm]
64	F002779	F002781	F002782	F002780	104	24	30

### RiexTouch XR20 ručkica

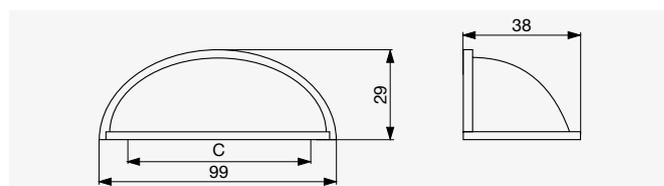

● Brušeni nikal

Dimenzija C [mm]	Brušeni nikal	Patinirani bakar	Patinirano zlato	Patinirani kositar
64	F002785	F002786	F002784	F002783

## ● RiexTouch XH21 ručnica

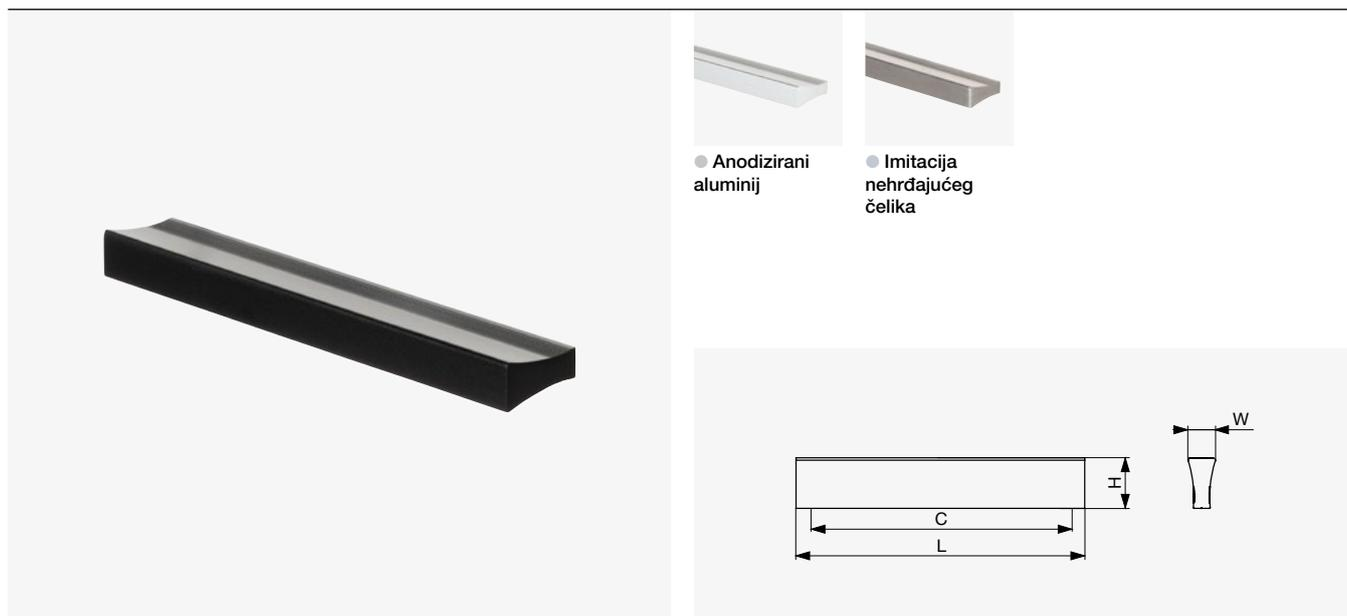

● Mat crna

Dimenzija C [mm]	Mat crna	Anodizirani aluminij	Imitacija nehrđajućeg čelika	Dimenzija L [mm]	Dimenzija H [mm]	Dimenzija W [mm]
96	F002624	F002618	F002621	106	19	10
128	F002625	F002619	F002622	138		
160	F002626	F002620	F002623	170		

## ● RiexTouch XH46 ručnica

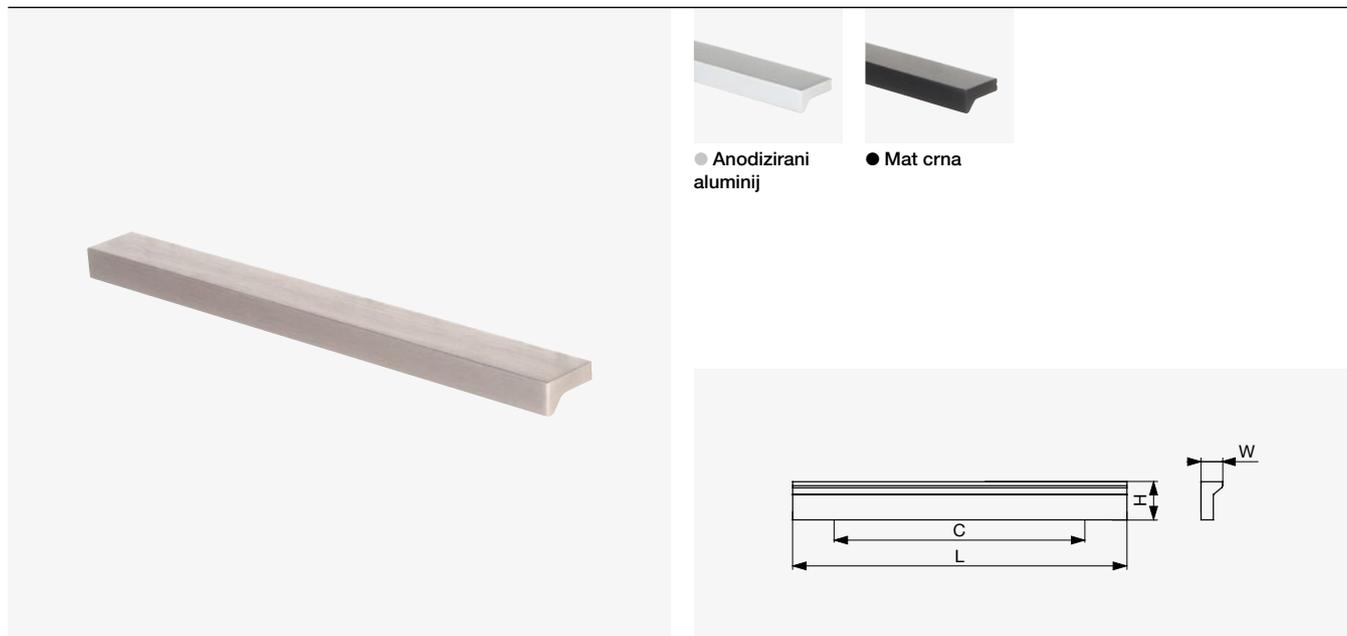

● Imitacija nehrđajućeg čelika

Dimenzija C [mm]	Imitacija nehrđajućeg čelika	Anodizirani aluminij	Mat crna	Dimenzija L [mm]	Dimenzija H [mm]	Dimenzija W [mm]
128	F002612	F002609	F002615	200	20	11
192	F002613	F002610	F002616	300		
256	F002614	F002611	F002617	400		

04

### RiexTouch XH27 ručkica



- Anodizirani aluminij
- Polirano krom

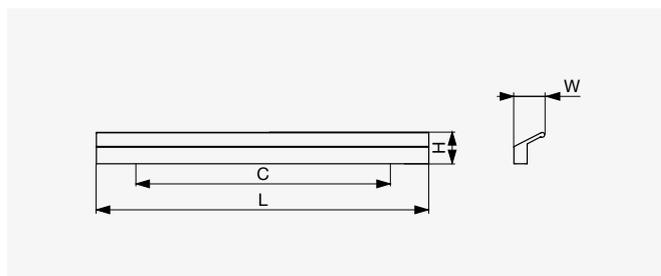

- Imitacija nehrđajućeg čelika

Dimenzija C [mm]	Imitacija nehrđajućeg čelika	Anodizirani aluminij	Polirano krom	Dimenzija L [mm]	Dimenzija H [mm]	Dimenzija W [mm]
96	F002603	F002600	F002606	116	19	19
160	F002604	F002601	F002607	180		
224	F002605	F002602	F002608	244		

### RiexTouch XZ09 ugradbena ručkica



- Mat crna
- Mat bijela

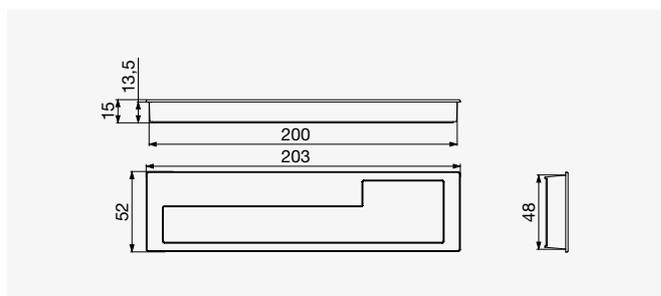

- Mat antracit

Stranica	Mat antracit	Mat crna	Mat bijela
Ljeva	F002765	F002763	F002761
Pravo	F002766	F002764	F002762



## ● RiexTouch XZ11 ugradbena ručkica

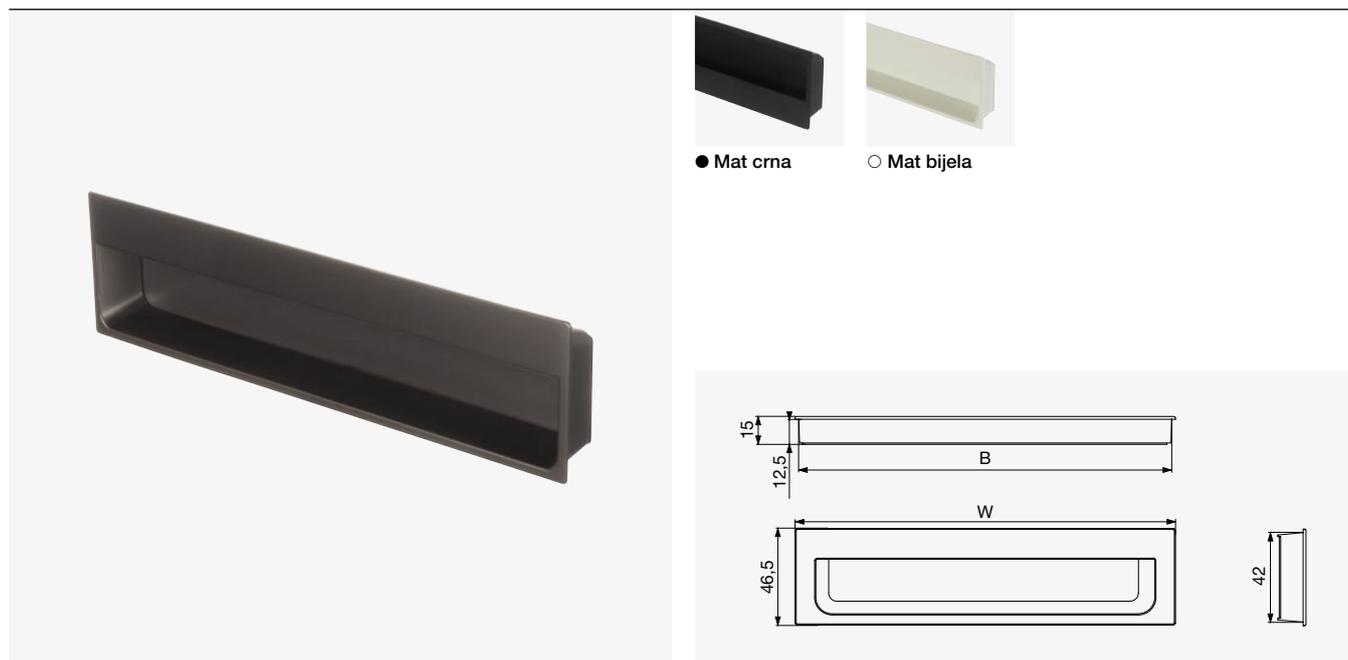

● Mat crna

○ Mat bijela

● Mat antracit

Dimenzija W [mm]	Mat antracit	Mat crna	Mat bijela	Dimenzija B [mm]
158	F002587	F002591	F002589	154
190	F002588	F002592	F002590	186

## ● RiexTouch XZ04 ugradbena ručkica

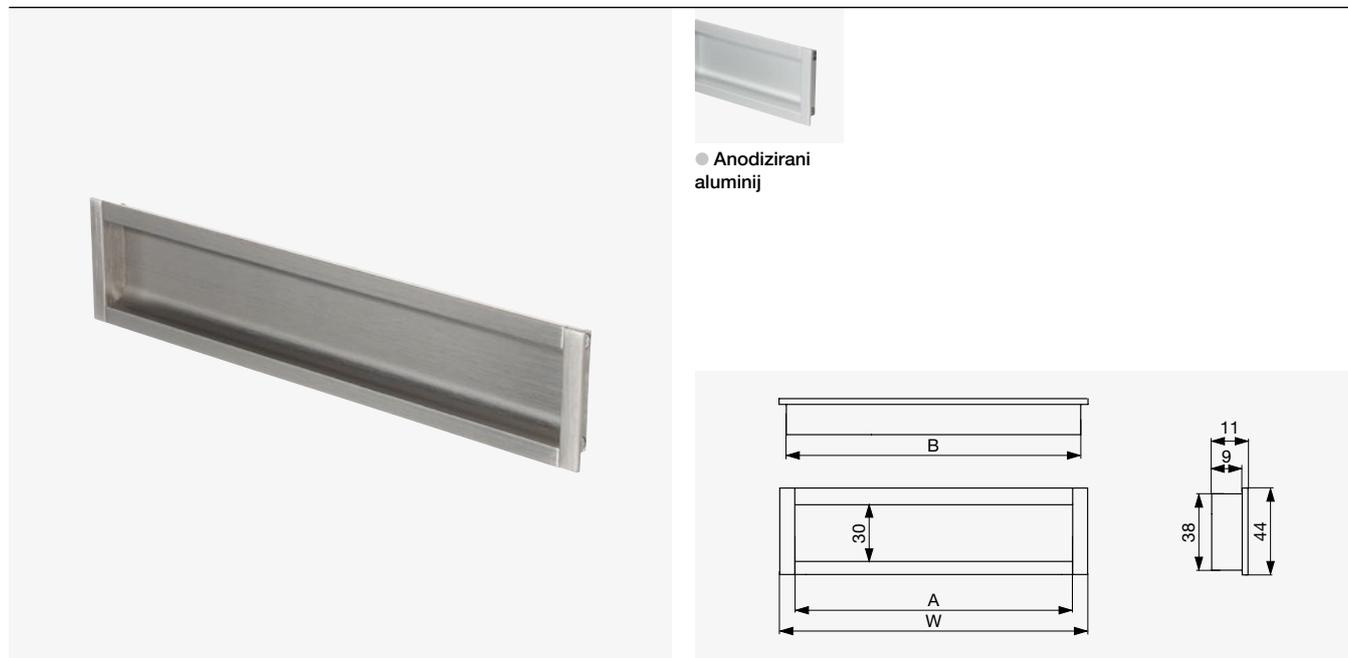

● Anodizirani aluminij

● Imitacija nehrđajućeg čelika

Dimenzija W [mm]	Imitacija nehrđajućeg čelika	Anodizirano aluminij	Dimenzija A [mm]	Dimenzija B [mm]
104	F001706	F001704	90	94
215	F001707	F001705	201	205

04

### ➤ RiexTouch XZ03 ugradbena ručkica

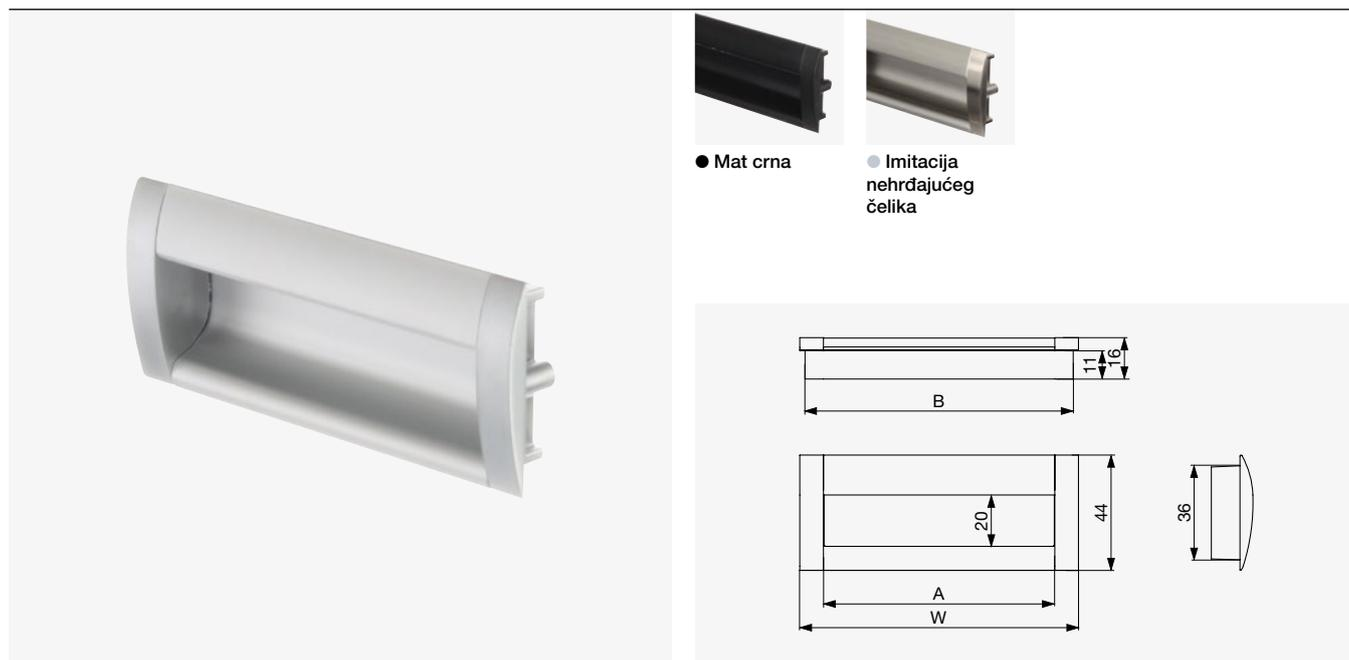

● Anodizirani aluminij

Dimenzija W [mm]	Anodizirani aluminij	Mat crna	Imitacija nehrđajućeg čelika	Dimenzija A [mm]	Dimenzija B [mm]
106	F001700	F001702	F001698	88	102
170	F001701	F001703	F001699	152	166

### ➤ RiexTouch XZ02 ugradbena ručkica

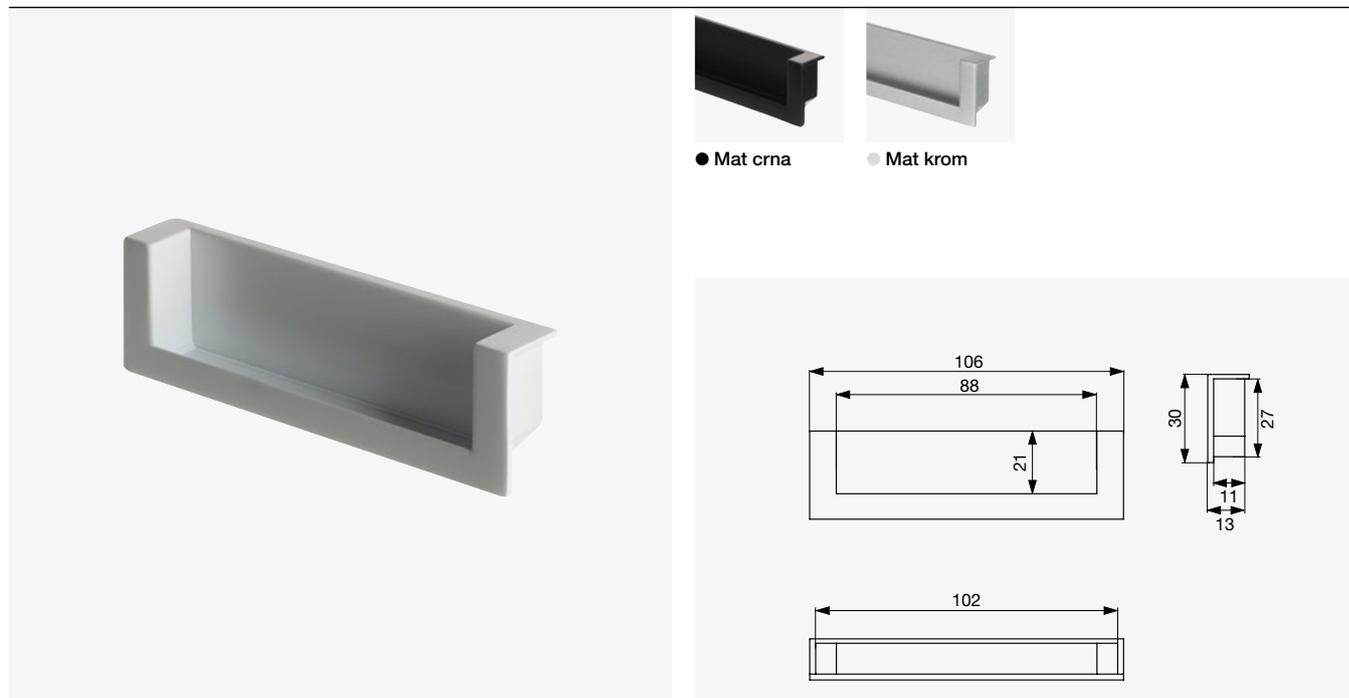

○ Mat bijela

Mat bijela	Mat crna	Mat krom
F002630	F002629	F002627

## ● RiexTouch XZ01 ugradbena ručica

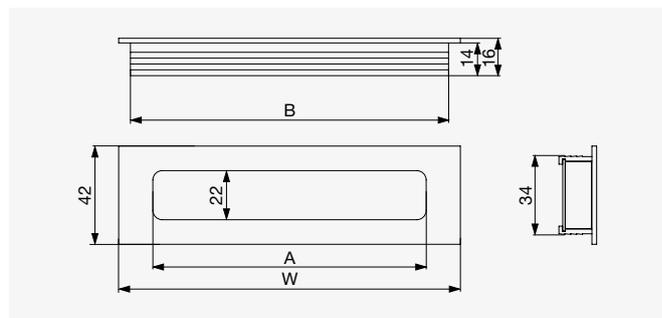

● Mat crna

● Imitacija  
nehrđajućeg  
čelika

● Anodizirani aluminij

Dimenzija W [mm]	Anodizirani aluminij	Mat crna	Imitacija nehrđajućeg čelika	Dimenzija A [mm]	Dimenzija B [mm]
112	F002767	F001786	F001783	84	106
144	F002631	F001787	F001784	116	138
176	F002768	F001788	F001785	148	170
272	F002632	x	x	244	266
336	F002633	x	x	308	330

## ● RiexTouch XZ10 ugradbena ručica



● Mat crna

○ Mat bijela

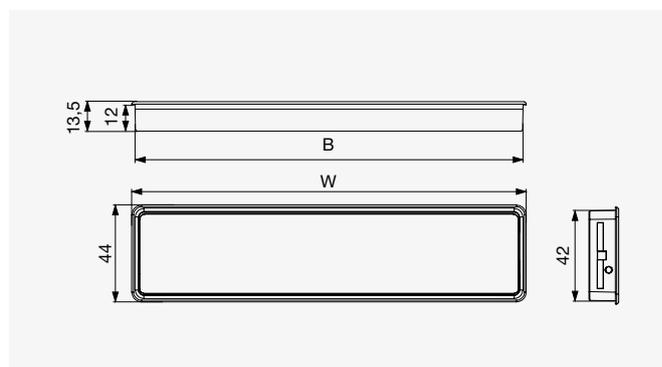

● Mat antracit

Dimenzija W [mm]	Mat antracit	Mat crna	Mat bijela	Dimenzija B [mm]
44	F002583	F002759	F002584	42
180	F002585	F002760	F002586	177

04

### ● RiexTouch XZ05 ugradbena ručkica





● Mat antracit



● Polirano krom

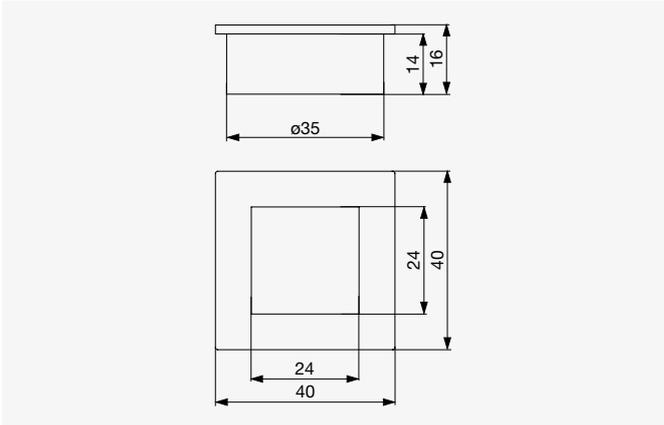

● Brušeni nikal	● Mat antracit	● Polirano krom
Brušeni nikal F001879	Mat antracit F001881	Polirano krom F001880

### ● RiexTouch XZ06 ugradbena ručkica





● Mat antracit



● Polirano krom

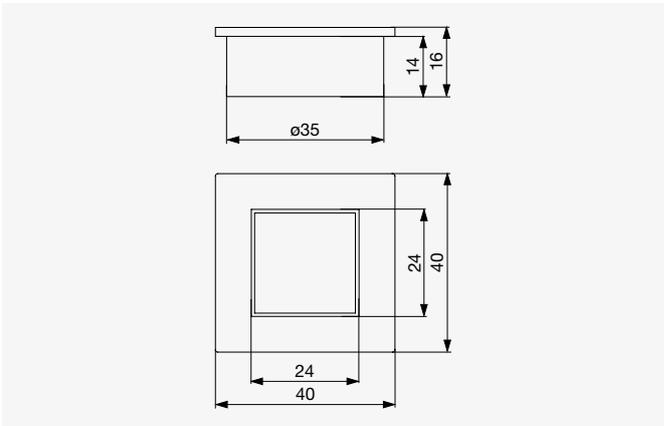

● Brušeni nikal	● Mat antracit	● Polirano krom
Brušeni nikal F001882	Mat antracit F001884	Polirano krom F001883

## ➊ RiexTouch XZ07 ugradbena ručkica



● Brušeni nikal    ● Mat antracit

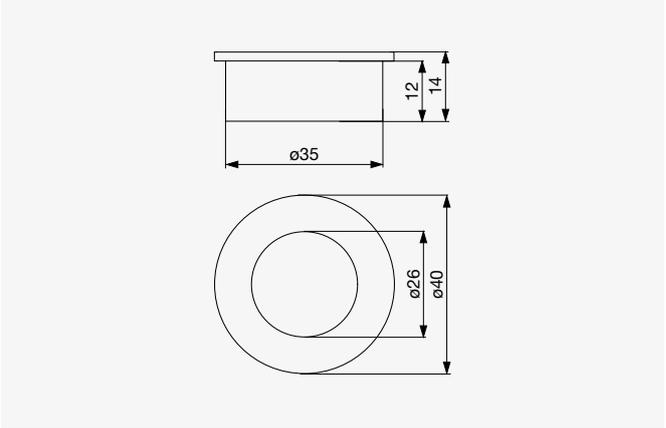

● Polirano krom

Polirano krom	Brušeni nikal	Mat antracit
F001886	F001885	F001887

## ➋ RiexTouch XZ08 ugradbena ručkica



● Brušeni nikal    ● Mat antracit

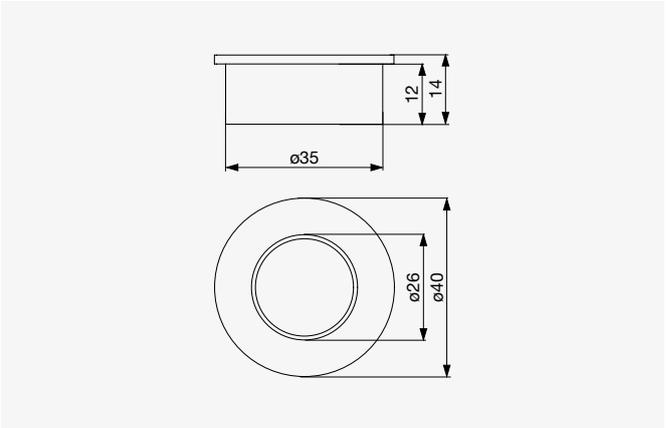

● Polirano krom

Polirano krom	Brušeni nikal	Mat antracit
F001889	F001888	F001890

04

### ⊕ RiexTouch XZ12 Udubljena ručkica





● Mat nikal



● Polirano krom

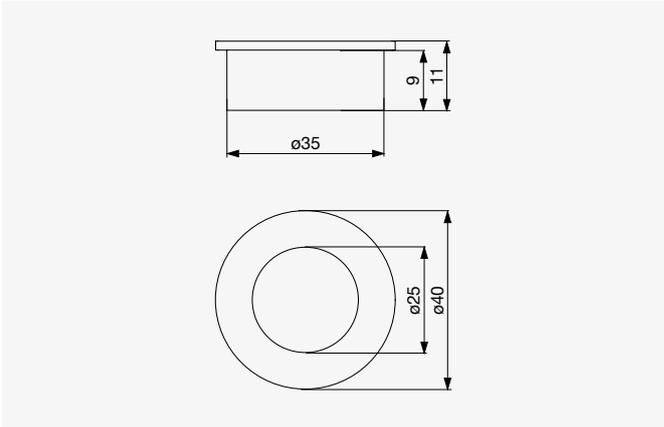

● Mat krom

---

Mat krom  
F002268

● Mat nikal

---

Mat nikal  
F002269

● Poliran krom

---

Poliran krom  
F002267

### ⊕ RiexTouch XK01 ručkica





● Mat krom



● Mat nikal



● Polirano krom

Nosач istog dizajna na str. 4.29.

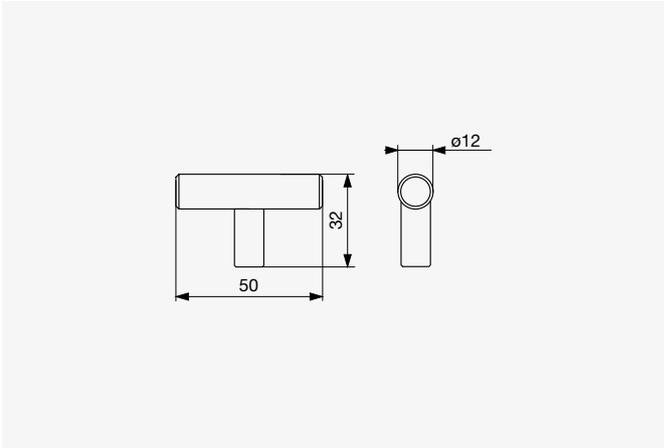

● Brušeni nikal

---

Brušeni nikal  
F002555

● Mat krom

---

Mat krom  
F002558

● Mat nikal

---

Mat nikal  
F002556

● Polirano krom

---

Polirano krom  
F002557

### ⊕ RiexTouch XK02 ručkica





● Mat crna



● Mat nikal



● Polirano krom



● Nehrđajući čelik

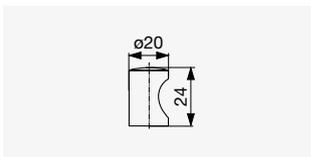

① F002770, F002757, F002756

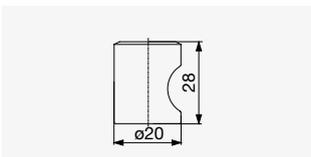

① F002202

Brušeni nikal	Mat crna	Mat nikal	Polirano krom	Nehrđajući čelik
F002758	F002770	F002757	F002756	F002202

### ⊕ RiexTouch XK11 ručkica

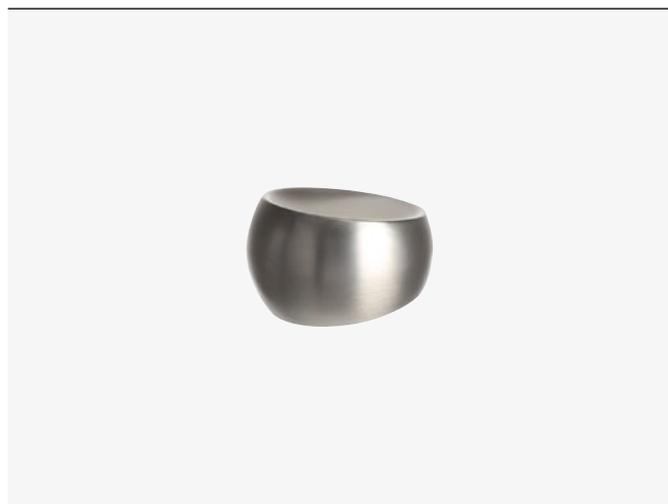



● Mat crna



○ Mat bijela



● Polirano krom

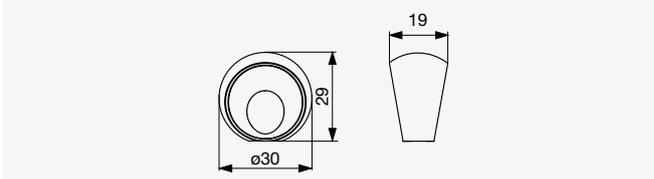

Brušeni nikal	Mat crna	Mat bijela	Polirano krom
F002275	F002274	F002277	F002276

### ⊕ RiexTouch XK05 ručkica





● Anodizirani aluminij



● Mat crna



● Mat crni nikal

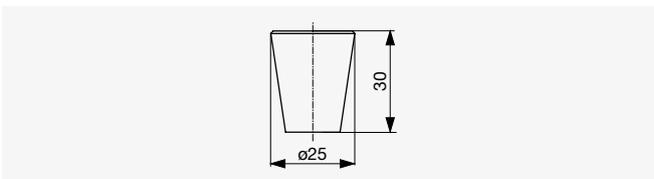

Mat zlato	Anodiziran aluminij	Mat crna	Mat crni nikal
F002273	F002272	F002270	F002271

01  
02  
03  
04  
05  
06  
07  
08  
09  
10  
11  
12  
13  
14  
15  
16  
17  
18

04

### ➤ RiexTouch XK03 ručkica





● Brušeni nikal



● Mat crna



● Mat krom



● Mat nikal



○ Mat bijela



● Polirano zlato

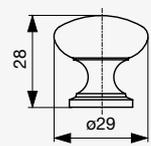

● Polirano krom							
Polirano krom	Brušeni nikal	Mat crna	Mat krom	Mat nikal	Mat bijela	Polirano zlato	
F002401	F002404	F002403	F002400	F002398	F002399	F002402	

### ➤ RiexTouch XK12 ručkica





● Mat krom



● Polirano zlato

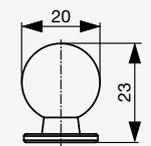

● Polirano krom			
Polirani krom	Mat krom	Polirano zlato	
F002250	F002251	F002252	



## ● RiexTouch XK13 ručkica



● Polirano krom



● Mat krom

● Polirano zlato

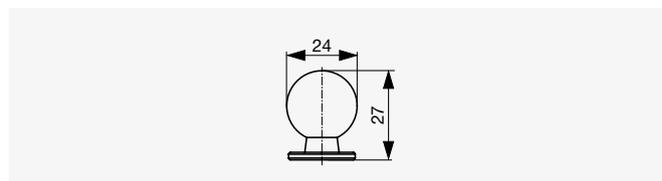

Polirano krom	Mat krom	Polirano zlato
F002253	F002254	F002255

## ● RiexTouch XK15 ručkica



● Brušeni nikal



● Mat krom

● Mat nikal

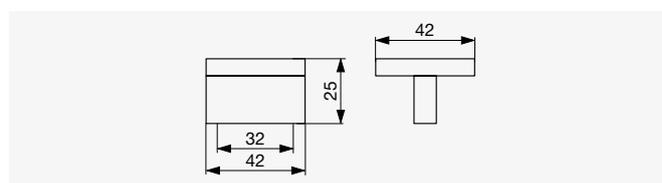

Brušeni nikal	Mat krom	Mat nikal
F002259	F002260	F007555

## ● RiexTouch XK08 ručkica

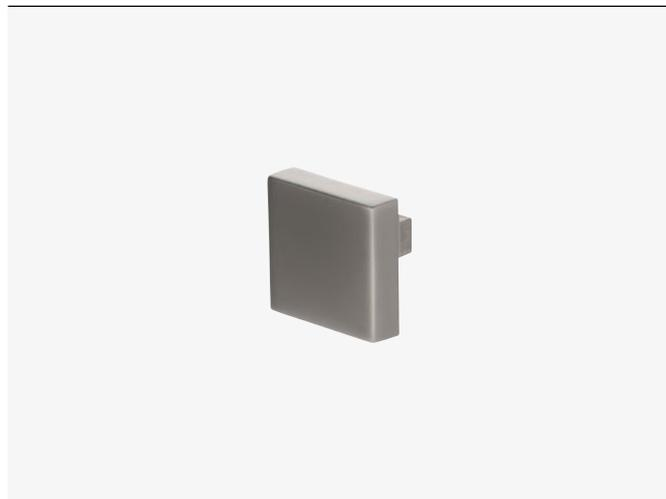

● Mat krom

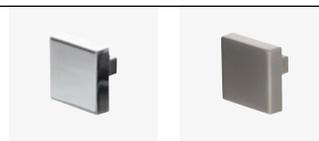

● Polirano krom

● Mat nikal

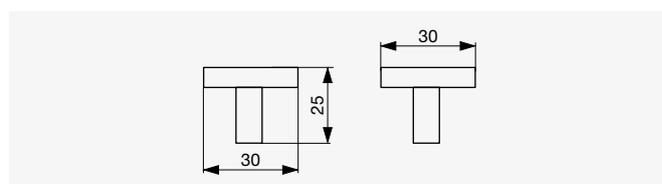

Mat krom	Polirano krom	Mat nikal
F002249	F002248	F007553

04

### ⊕ RiexTouch XV28 ručkica

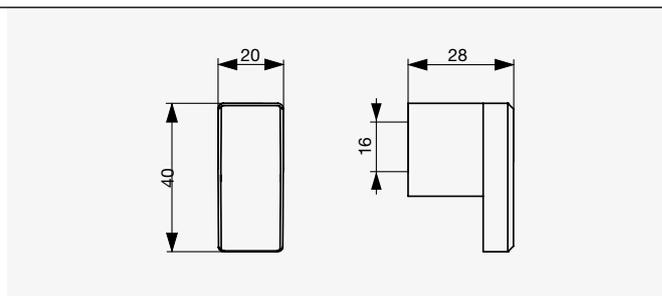

Ručkica istog dizajna na str. 4.43.  
Drška istog oblika na str. 4.95.

Mat  
crna  
F002468

● Mat crna

### ⊕ RiexTouch XK14 ručkica



● Brušeni nikal ● Polirano krom ● Mat nikal

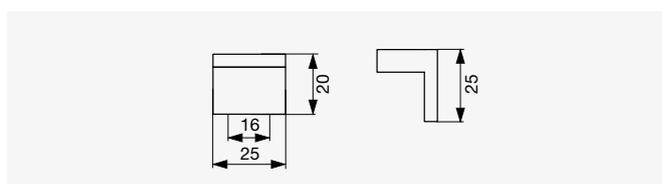

Mat krom	Brušeni nikal	Polirano krom	Mat nikal
F002258	F002256	F002257	F007554

● Mat krom

### ⊕ RiexTouch XK16 ručkica



● Anodizirani aluminij

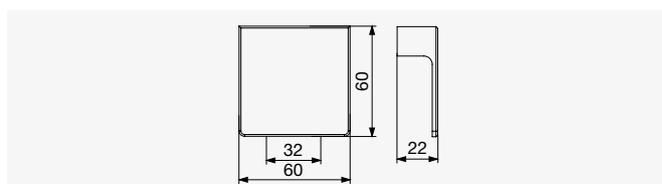

Mat crna	Anodizirani aluminij
F002282	F002281

● Mat crna

## ● RiexTouch XK09 ručkica



● Mat antracit



● Brušeno zlato

● Mat krom

Vješalica istog dizajna na str. 4.93.

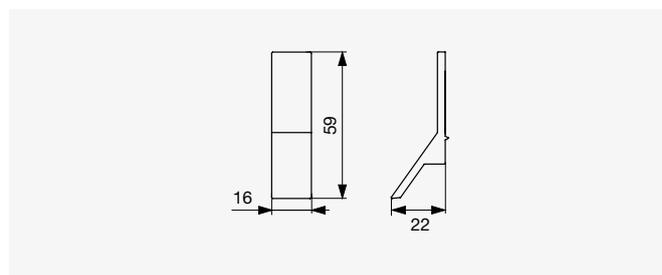

Mat antracit	Polirano zlato	Mat krom
F002594	F002593	F002595

04

**RiexTouch XH04 ručkica** **ECONOMY**



● Mat krom ● Polirano krom

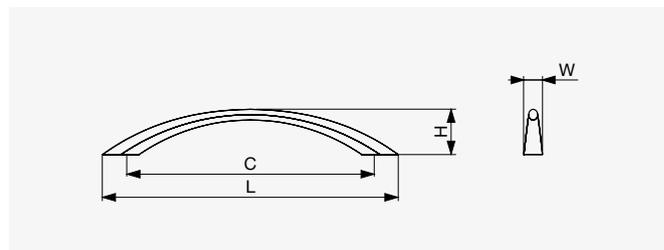

● Mat nikal

Dimenzija C [mm]	Mat nikal	Mat krom	Polirano krom	Dimenzija L [mm]	Dimenzija H [mm]	Dimenzija W [mm]
96	F001748	F001746	F001744	112	23	9
128	F001749	F001747	F001745	159	25	10

**RiexTouch XH09 ručkica** **ECONOMY**

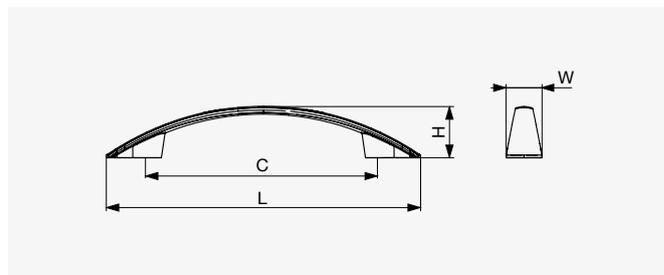

● Polirano krom

Dimenzija C [mm]	Polirano krom	Dimenzija L [mm]	Dimenzija H [mm]	Dimenzija W [mm]
96	F002234	135	22,5	15,5
128	F002235	169	23	16

## ➊ RiexTouch XH33 ručica **ECONOMY**



● Mat crna    ● Mat krom    ● Mat nikal    ● Polirano zlato

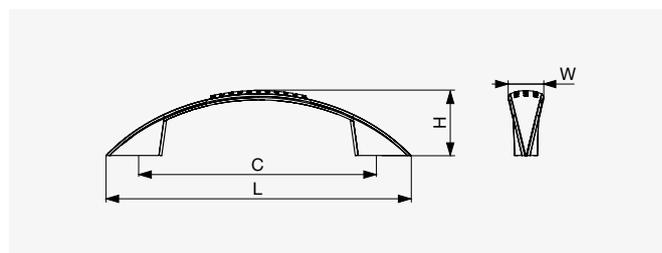

● Polirano krom

Dimenzija C [mm]	Poliran krom	Mat crna	Mat krom	Mat nikal	Poliran zlato	Dimenzija L [mm]	Dimenzija H [mm]	Dimenzija W [mm]
96	F002115	F002117	F002113	F002111	F002119	128	27,5	15
128	F002116	F002118	F002114	F002112	F002120	163	28,5	16

## ➋ RiexTouch XH34 ručica **ECONOMY**



● Mat crna    ● Mat krom    ● Mat nikal    ● Polirano zlato

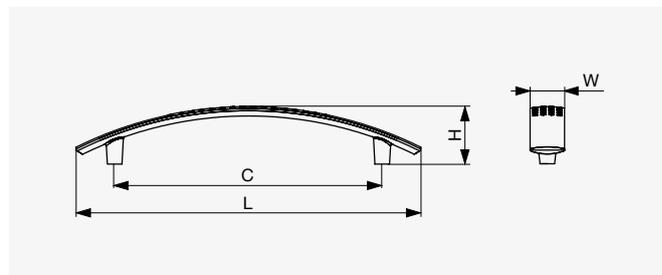

● Polirano krom

Dimenzija C [mm]	Poliran krom	Mat crna	Mat krom	Mat nikal	Poliran zlato	Dimenzija L [mm]	Dimenzija H [mm]	Dimenzija W [mm]
96	F002125	F002127	F002123	F002121	F002129	124	27	17
128	F002126	F002128	F002124	F002122	F002130	165,5	28	17

01  
02  
03  
04  
05  
06  
07  
08  
09  
10  
11  
12  
13  
14  
15  
16  
17  
18

04

**➤ RiexTouch XH37 ručkica** **ECONOMY**



● Polirano krom

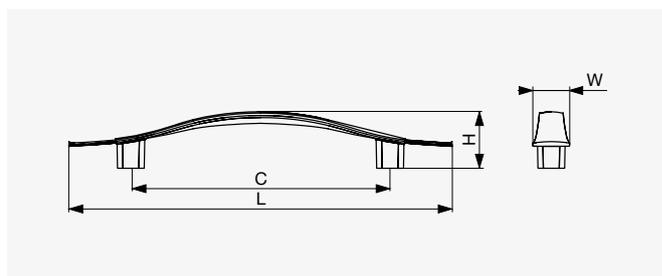

● Mat nikal

Dimenzija C [mm]	Mat nikal	Polirani krom	Dimenzija L [mm]	Dimenzija H [mm]	Dimenzija W [mm]
96	F002381	F002380	143	21,5	14

**➤ RiexTouch XK10 ručkica** **ECONOMY**



● Mat crna



● Mat krom



● Mat nikal

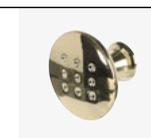

● Polirano zlato

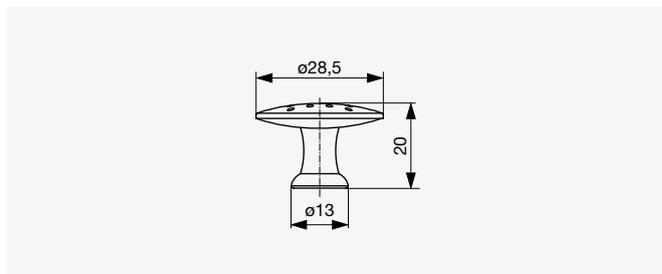

● Polirano krom

Poliran krom	Mat crna	Mat krom	Mat nikal	Poliran zlato
F002138	F002139	F002137	F002136	F002140

## ➤ RiexTouch XK07 ručnica **ECONOMY**

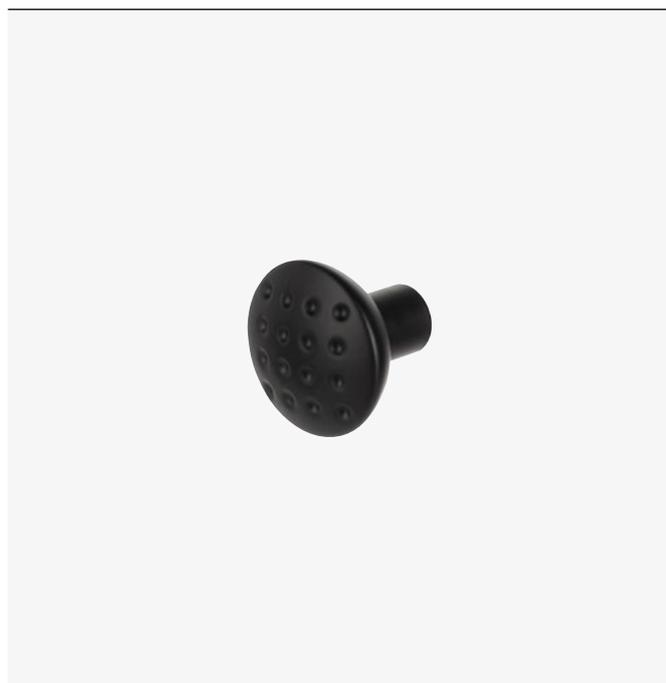

● Mat crna



● Mat krom ● Mat nikal ● Polirano zlato ● Polirano krom

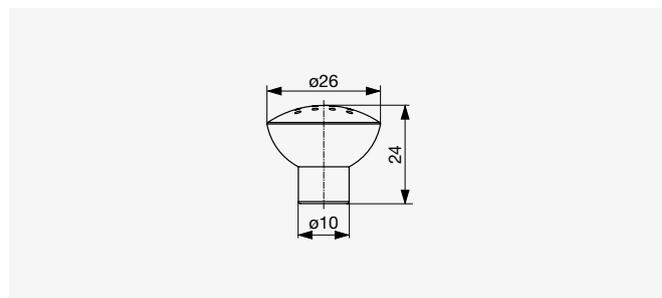

Mat crna	Mat krom	Mat nikal	Polirano zlato	Polirano krom
F002134	F002132	F002131	F002135	F002133

## ➤ RiexTouch XK06 ručnica **ECONOMY**



● Crna sa sjajem



○ Sjajna bijela ● Mat crna ● Mat krom ● Mat nikal



● Polirano zlato ● Polirano krom

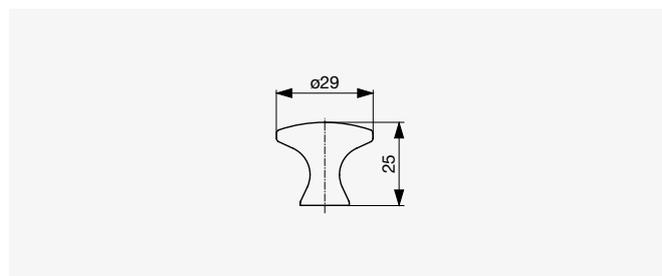

Crna sa sjajem	Sjajna bijela	Mat crna	Mat krom	Mat nikal	Polirano zlato	Polirano krom
F001750	F001755	F001751	F001753	F001754	F001756	F001752

# Porculan ručnice

04





● Citterio Giulio XR28 ručkica

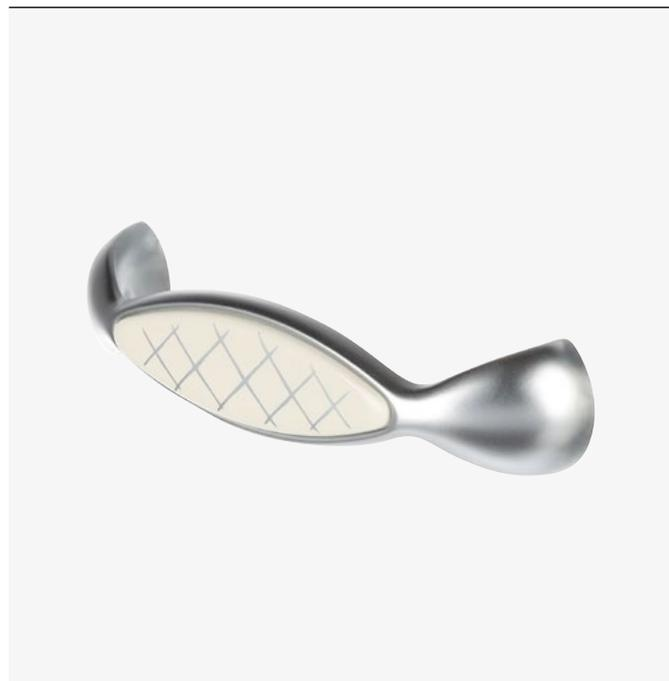

● Mat krom / porcelan



● Mat bronca / porculan

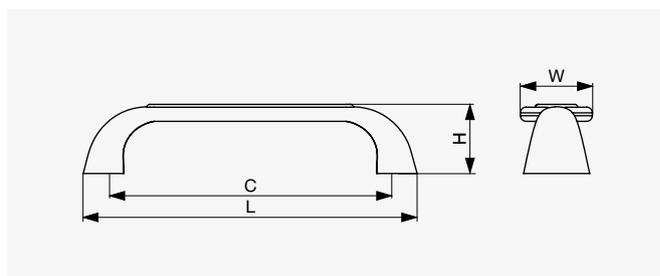

Dimenzija C [mm]	Mat krom / porcelan	Mat bronz / porcelan	Dimenzija L [mm]	Dimenzija H [mm]	Dimenzija W [mm]
96	F003236	F003235	116	25	23

● Citterio Giulio XR28 ručkica



● Mat krom / porcelan



● Mat bronca / porculan

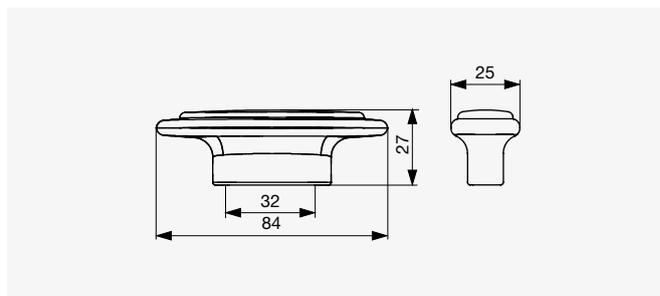

Mat krom / porcelan	Mat bronca / porcelan
F003238	F003237

01  
02  
03  
04  
05  
06  
07  
08  
09  
10  
11  
12  
13  
14  
15  
16  
17  
18

04

● Citterio Giulio XR29 ručkica



● Mat bronca / porculan

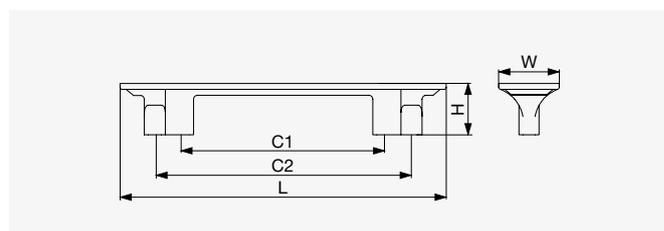

● Mat nikal / porculan

Dimenzija C1 / C2 [mm]	Mat nikal / porculan	Mat bronca / porculan	Dimenzija L [mm]	Dimenzija H [mm]	Dimenzija W [mm]
96 / 128	F003240	F003239	162	26	30

● Citterio Giulio XR29 ručkica



● Mat bronca / porculan

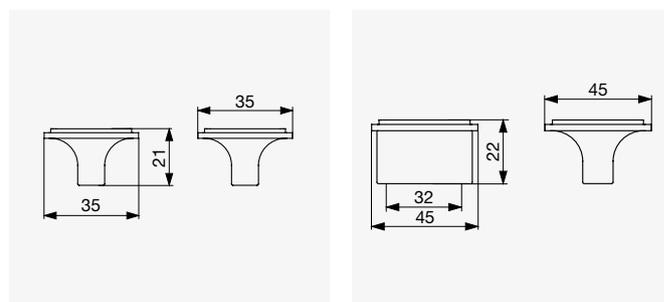

● Mat nikal / porculan

Dimenzija [mm]	Mat nikal / porculan	Mat bronca / porculan
35 x 35	F003242	F003241
45 x 45	F003244	F003243

## ● RiexTouch XR21 ručkica

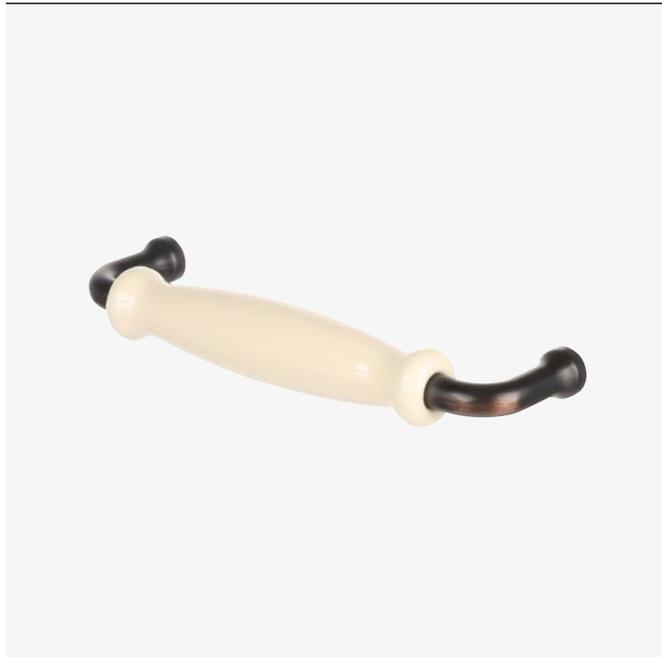

● Patinirano  
zlatno / porculan

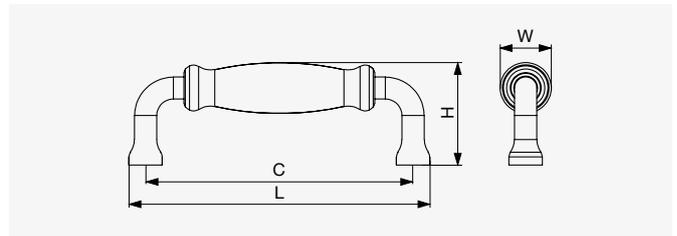

● Patinirano smeđe / porculan

Dimenzija C [mm]	Patinirana smeđa boja / porculan	Patinirano zlatno / porculan	Dimenzija L [mm]	Dimenzija H [mm]	Dimenzija W [mm]
96	F002787	F002789	108	27	19
128	F002788	F002790	140	38	20

## ● RiexTouch XR22 ručkica



● Patinirano  
zlatno / porculan

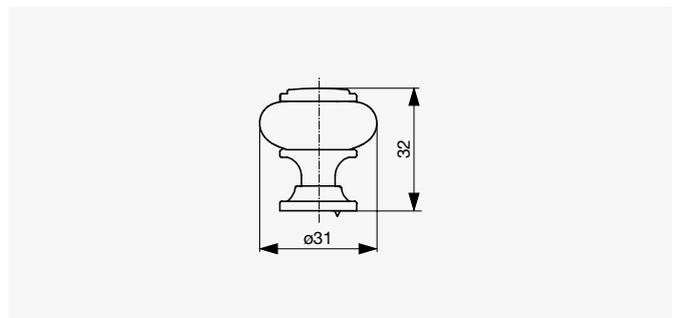

● Patinirano smeđe / porculan

Patinirano smeđe / porculan	Patinirano zlatno / porculan
F002791	F002792

# Plastične ručkice i kvake

04

## ● Citterio Giulio XD01 ručkica



● Polirani krom / prozirni polikarbonat

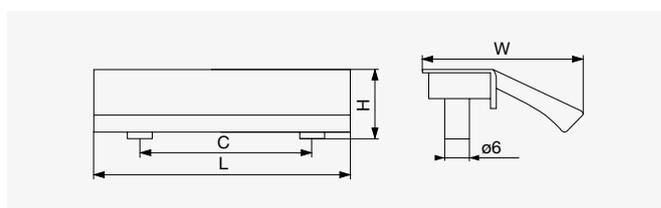

● Titanska bronca / smeđi polikarbonat

Dimenzija C [mm]	Titanska bronca / smeđi polikarbonat	Polirani krom / prozirni polikarbonat	Dimenzija L [mm]	Dimenzija H [mm]	Dimenzija W [mm]
32	F003161	F003160	65	16	36
128	F003163	F003162	160		

## ● Citterio Giulio XD02 ručkica

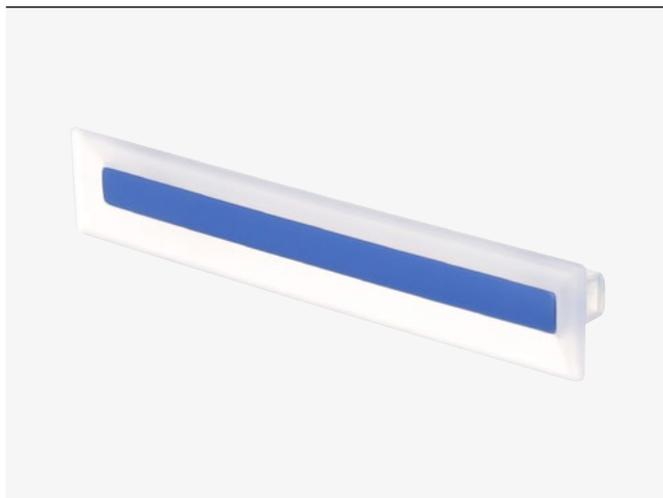

● Ružičasta

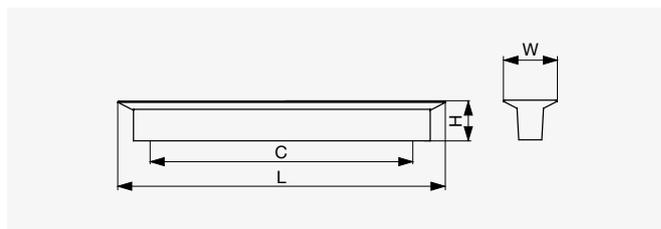

● Plava

Dimenzija C [mm]	Plava	Ružičasta	Dimenzija L [mm]	Dimenzija H [mm]	Dimenzija W [mm]
96	F003196	F003197	140		
128	F003198	F003199	172	21	29
160	F003200	F003201	204		

## ● Citterio Giulio XD02 ručkica

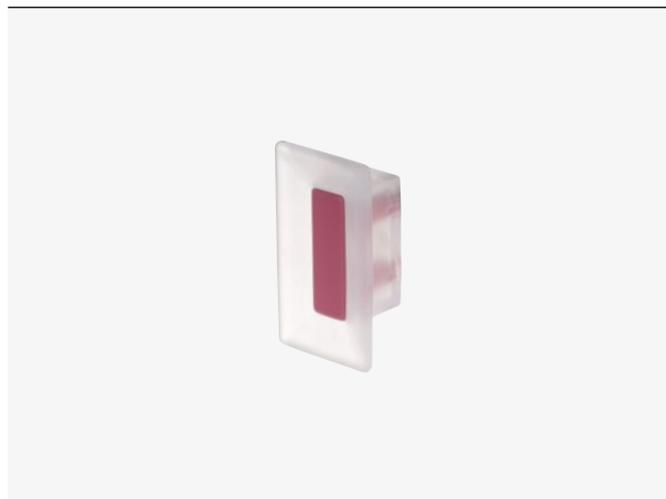

● Ružičasta



● Plava

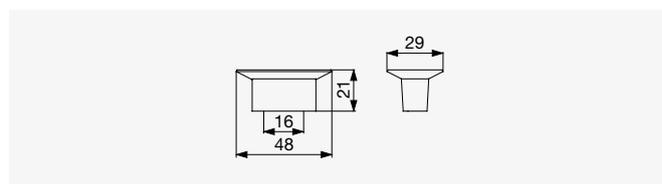

Ružičasto

Plava

F003195

F003194

## ● Citterio Giulio XD03 ručkica

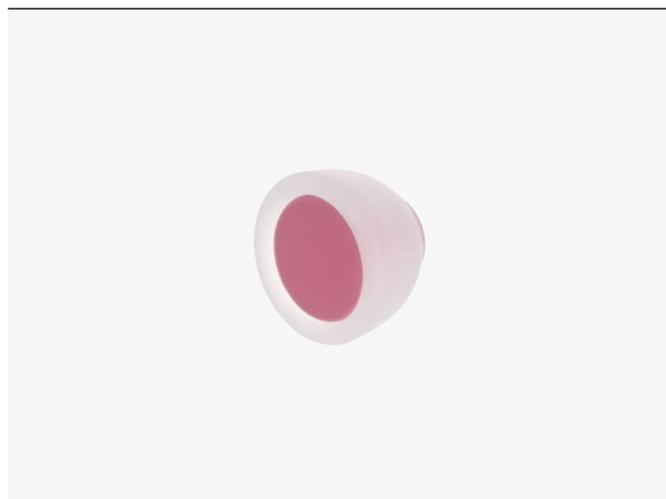

● Ružičasta



● Plava

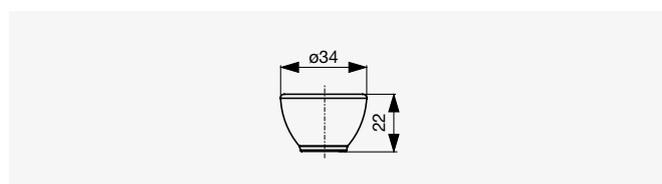

Ružičasto

Plava

F003203

F003202

## ● Citterio Giulio XD04 ručkica

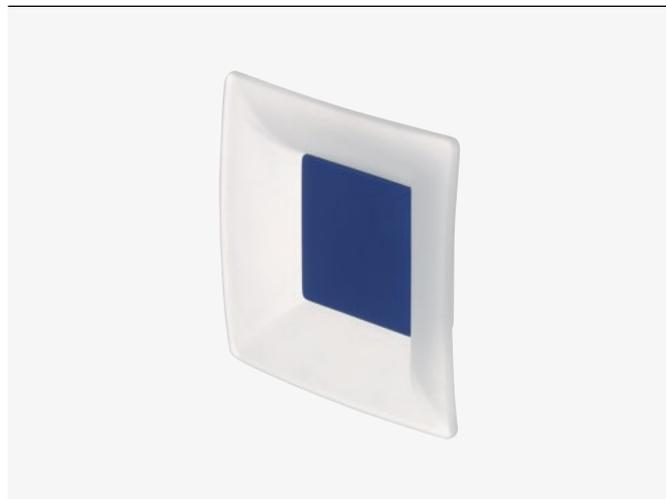

● Plava



● Ružičasta

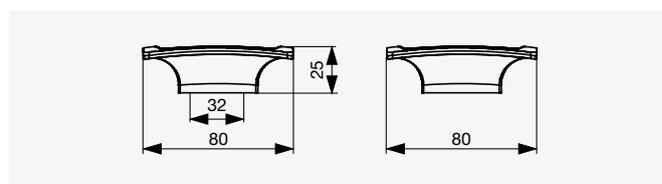

Plava

Ružičasto

F003204

F003205

# Drvene ručkice i kvake

04



## ● RiexTouch XT10 ručkica



Gumb istog dizajna na str. 4.76.

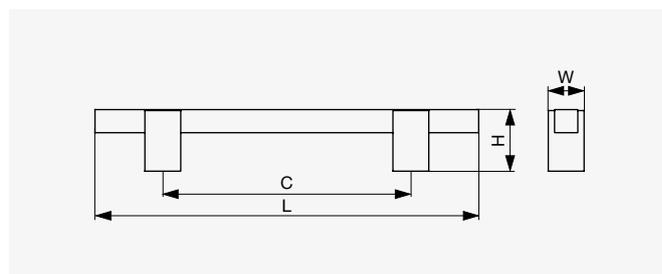

● Lakirani prirodni hrast / crno bajcovani hrast

Dimenzija C [mm]	Lakirani prirodni hrast / crno bajcovani hrast	Dimenzija L [mm]	Dimenzija H [mm]	Dimenzija W [mm]
128	F004976	198	32	18,5
224	F004977	294		

## ● RiexTouch XT07 ručkica



● Nelakirani prirodni hrast

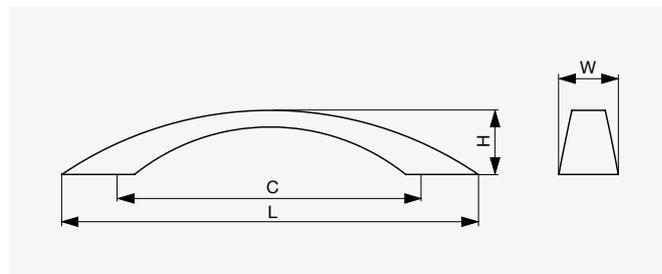

● Lakirani prirodni hrast

Dimenzija C [mm]	Lakirano prirodni hrast	Nepremazan prirodni hrast	Dimenzija L [mm]	Dimenzija H [mm]	Dimenzija W [mm]
128	F004970	F004971	175	27	25

04

### ➤ RiexTouch XT13 ručkica

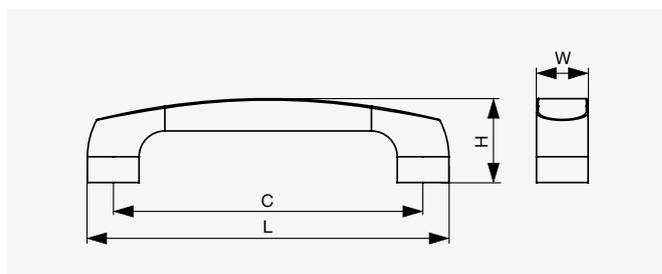

● Lakirani prirodni bor

Dimenzija C [mm]	Lakirani prirodni bor	Dimenzija L [mm]	Dimenzija H [mm]	Dimenzija W [mm]
96	F004985	112	26	16
128	F004986	144		

### ➤ RiexTouch XT08 ručkica



● Lakirani prirodni hrast

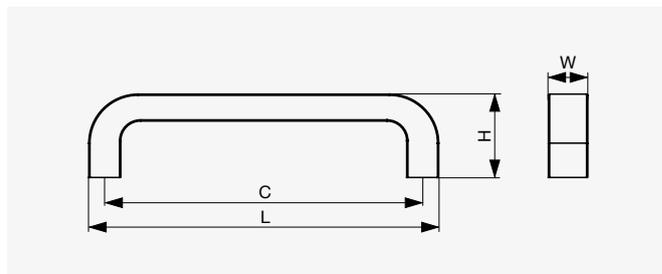

● Lakirana prirodna bukva

Dimenzija C [mm]	Lakirana prirodna bukva	Lakirani prirodni hrast	Dimenzija L [mm]	Dimenzija H [mm]	Dimenzija W [mm]
128	F004972	F004973	142	34	16



## ● RiexTouch XT09 ručkica



● Lakirani prirodni hrast

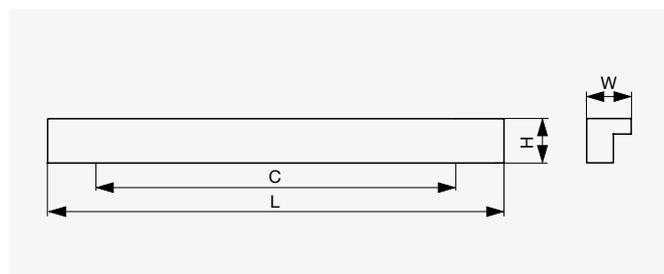

● Nelakirani prirodni hrast

Dimenzija C [mm]	Nepremazan prirodni hrast	Lakirano prirodni hrast	Dimenzija L [mm]	Dimenzija H [mm]	Dimenzija W [mm]
160	F004974	F004975	205	20	20

## ● RiexTouch XT14 ručkica

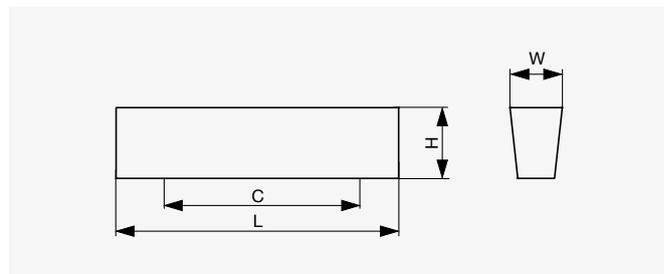

● Lakirani prirodni hrast

Dimenzija C [mm]	Lakirano prirodni hrast	Dimenzija L [mm]	Dimenzija H [mm]	Dimenzija W [mm]
64	F004987	100	25	18,5

04

### RiexTouch XT12 ručkica

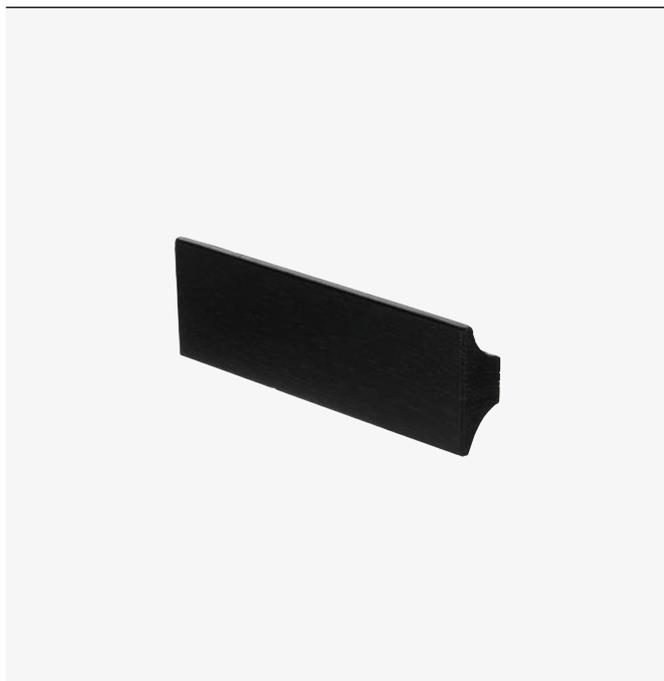

● Nelakirani prirodni hrast

● Lakirani prirodni hrast

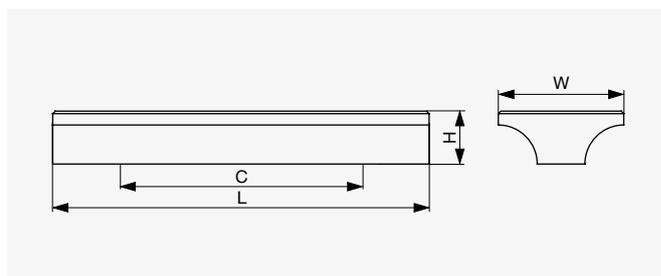

● Lakirani crno bajcovani hrast

Dimenzija C [mm]	Lakirani crno bajcovani hrast	Nelakirani prirodni hrast	Lakirani prirodni hrast	Dimenzija L [mm]	Dimenzija H [mm]	Dimenzija W [mm]
96	F004982	F004983	F004984	150	21	50

### RiexTouch XT06 ručkica



● Nelakirana prirodna bukva

● Nelakirani prirodni bor

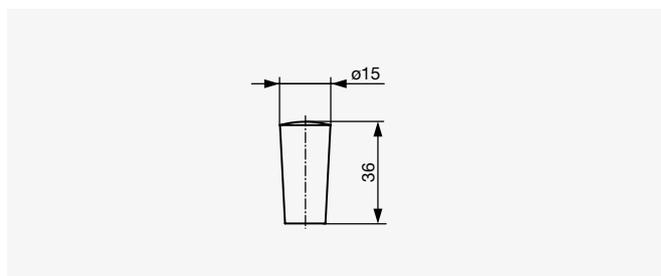

● Nelakirani prirodni hrast

Nelakirani prirodni hrast	Nelakirana prirodna bukva	Nelakirani prirodni bor
F004967	F004968	F004969

## ☉ RiexTouch XT01 ručkica





● Nelakirana prirodna bukva



● Nelakirani prirodni bor



● Lakirani prirodni hrast



● Lakirana prirodna bukva



● Lakirani prirodni bor

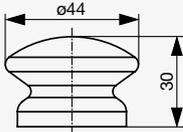

● Nelakirani prirodni hrast

Nelakirani prirodni hrast	Nelakirana prirodna bukva	Nelakirani prirodni bor	Lakirani prirodni hrast	Lakirana prirodna bukva	Lakirani prirodni bor
F004940	F004941	F004942	F004943	F004944	F004945

## ☉ RiexTouch XT04 ručkica





● Nelakirana prirodna bukva



● Nelakirani prirodni bor



● Lakirani prirodni hrast



● Lakirana prirodna bukva



● Lakirani prirodni bor

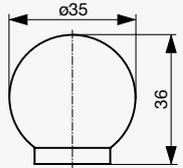

● Nelakirani prirodni hrast

Nepremazan prirodni hrast	Nepremazan prirodna bukva	Nepremazan prirodni bor	Lakirano prirodni hrast	Lakirano prirodna bukva	Lakirano prirodni bor
F004958	F004959	F004960	F004961	F004962	F004963

04

### RiexTouch XT02 ručkica





● Nelakirana prirodna bukva



● Nelakirani prirodni bor

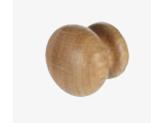

● Lakirani prirodni hrast



● Lakirana prirodna bukva



● Lakirani prirodni bor

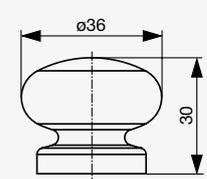

● Nelakirani prirodni hrast

Nelakirani prirodni hrast	Nelakirana prirodna bukva	Nelakirani prirodni bor	Lakirani prirodni hrast	Lakirana prirodna bukva	Lakirani prirodni bor
F004946	F004947	F004948	F004949	F004950	F004951

### RiexTouch XT03 ručkica





● Nelakirana prirodna bukva

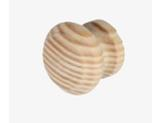

● Nelakirani prirodni bor



● Lakirani prirodni hrast

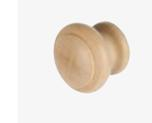

● Lakirana prirodna bukva

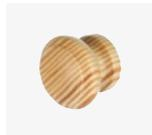

● Lakirani prirodni bor

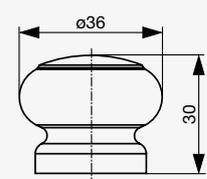

● Nelakirani prirodni hrast

Nepremazan prirodni hrast	Nepremazan prirodna bukva	Nepremazan prirodni bor	Lakirano prirodni hrast	Lakirano prirodna bukva	Lakirano prirodni bor
F004952	F004953	F004954	F004955	F004956	F004957

## ☉ RiexTouch XT05 ručkica

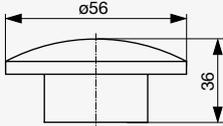
	 ● Nelakirana prirodna bukva	 ● Nelakirani prirodni bor	
● Nelakirani prirodni hrast			
Nelakirani prirodni hrast	Nelakirana prirodna bukva	Nelakirani prirodni bor	
F004964	F004965	F004966	

## ☉ RiexTouch XT11 ručkica

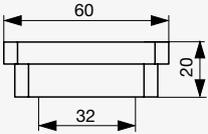
	 ● Lakirani prirodni hrast	 ● Lakirano crno bajcani hrast	
● Nelakirani prirodni hrast			
Nelakirani prirodni hrast	Lakirani prirodni hrast	Crno bajcani hrast	
F004979	F004980	F004981	

## ☉ RiexTouch XT10 ručkica

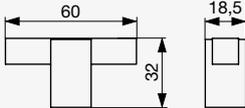
	 ● Lakirani prirodni hrast / crno bajcovani hrast	
	Ručka istog dizajna str. 4.70.	
	Lakirani prirodni hrast / crno bajcovani hrast	
	F004978	

# Vijci i vijčani profili

04



## ⊕ Profil RiexTouch XP01

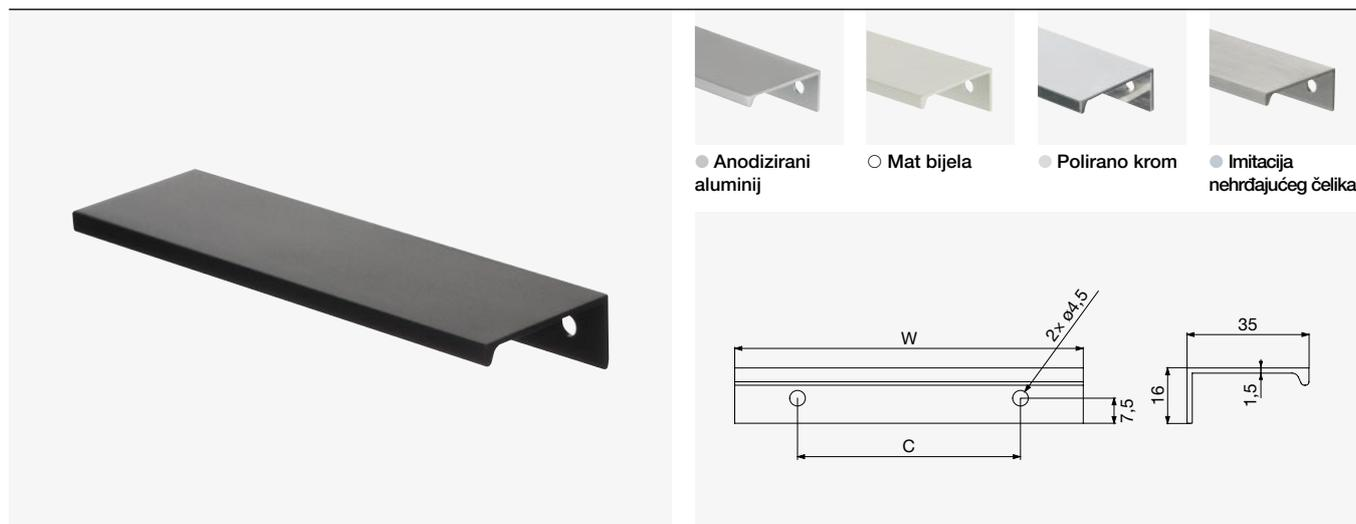

● Mat crna

Dimenzija C [mm]	Mat crna	Anodizirani aluminij	Mat bijela	Polirano krom	Imitacija nehrđajućeg čelika	Dimenzija W [mm]
32	F001444	F001429	F001435	F001423	F001417	52
64	F001442	F001430	F001436	F001424	F001418	84
96	F001445	F001431	F001437	F001425	F001419	116
160	F001441	F001432	F001438	F001426	F001420	180
320	F001443	F001433	F001439	F001427	F001421	340
480	F001446	F001434	F001440	F001428	F001422	500

## ⊕ RiexTouch XP41 Drive-In profil

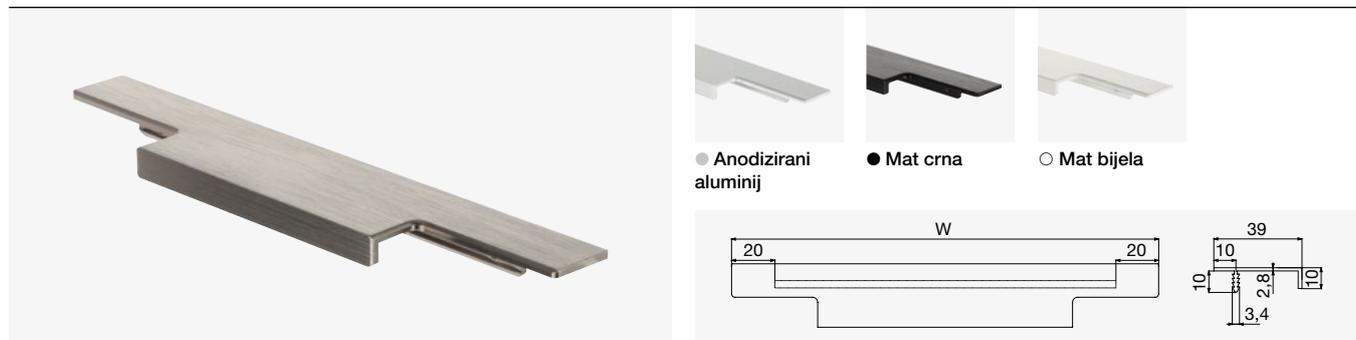

● Imitacija nehrđajućeg čelika

Dimenzija W [mm]	Imitacija nehrđajućeg čelika	Anodizirani aluminij	Mat crna	Mat bijela
146	F007401	F007402	F007403	F007404
196	F001447	F001457	F001467	F001477
296	F001448	F001458	F001468	F001478
396	F001449	F001459	F001469	F001479
446	F001450	F001460	F001470	F001480
496	F001451	F001461	F001471	F001481
596	F001452	F001462	F001472	F001482
696	F001453	F001463	F001473	F001483
796	F001454	F001464	F001474	F001484
896	F001455	F001465	F001475	F001485
996	F001456	F001466	F001476	F001486

04

### ☉ RiexTouch XP45 Drive-In profil

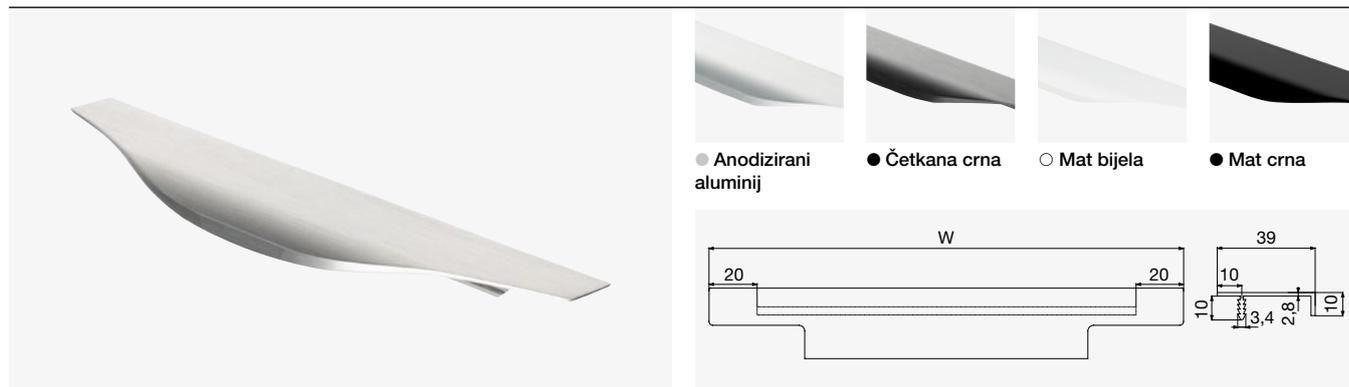

● Imitacija nehrđajućeg čelika

Dimenzija W [mm]	Imitacija nehrđajućeg čelika	Anodizirani aluminij	Četkana crna	Mat bijela	Mat crna
146	F007398	F007399	-	F007400	F007387
196	F001487	F001497	F001507	F001517	F007388
296	F001488	F001498	F001508	F001518	F007389
396	F001489	F001499	F001509	F001519	F007390
446	F001490	F001500	F001510	F001520	F007391
496	F001491	F001501	F001511	F001521	F007392
596	F001492	F001502	F001512	F001522	F007393
696	F001493	F001503	F001513	F001523	F007394
796	F001494	F001504	F001514	F001524	F007395
896	F001495	F001505	F001515	F001525	F007396
996	F001496	F001506	F001516	F001526	F007397



### ⊕ RiexTouch XP60 Drive-In profil



● Anodizirani aluminij



● Imitacija nehrđajućeg čelika

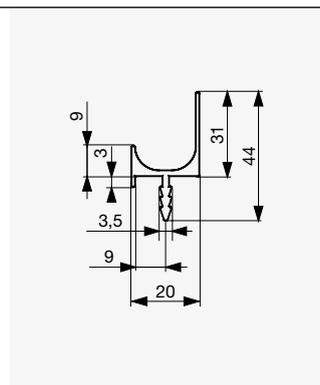

Duljina [mm]	Anodizirani aluminij	Imitacija nehrđajućeg čelika
2900	F002319	F002320

### ⊕ RiexTouch XP63 Drive-In profil



● Anodizirani aluminij



● Imitacija nehrđajućeg čelika

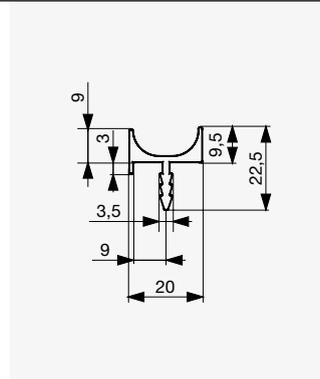

Duljina [mm]	Anodizirani aluminij	Imitacija nehrđajućeg čelika
2900	F002321	F002322

### ⊕ RiexTouch XP65 Drive-In profil



● Anodizirani aluminij



● Imitacija nehrđajućeg čelika

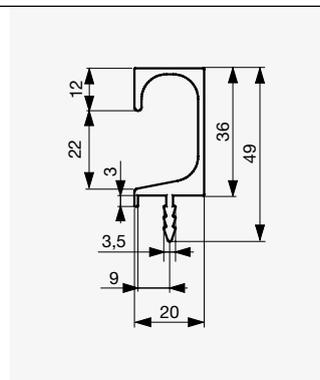

Duljina [mm]	Anodizirani aluminij	Imitacija nehrđajućeg čelika
2900	F002323	F002324

# Gola profili

04



# RiexTouch XG20 Gola L oblik

## Ⓜ RiexTouch XG20 Gola L profil



○ Mat bijela

● Anodizirani  
aluminij● Imitacija  
nehrđajućeg  
čelika

● Mat crna

Horizontalni sustav Gola.  
Držač profila na str. 4.86.

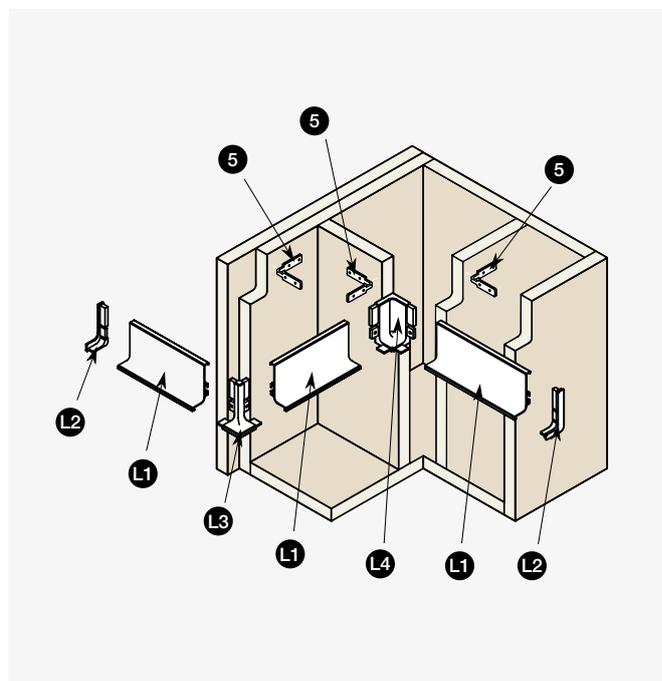
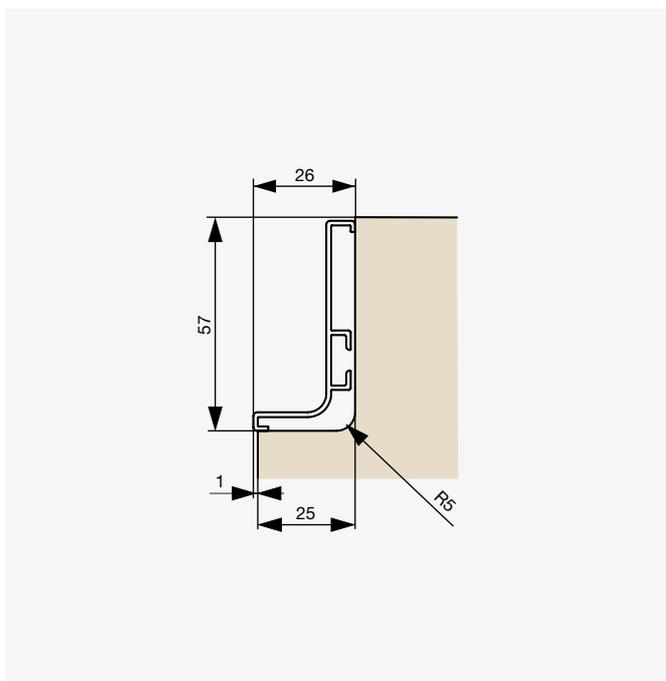

Duljina [mm]	Mat bijela	Anodizirani aluminij	Imitacija nehrđajućeg čelika	Mat crna
2900	F002285	F002283	F002284	F002286

01  
02  
03  
04  
05  
06  
07  
08  
09  
10  
11  
12  
13  
14  
15  
16  
17  
18

04

### ② RiexTouch XG20 Gola otvoreni završeci



● Anodizirani aluminij    ● Imitacija nehrđajućeg čelika    ● Mat crna

○ Mat bijela

Set lijevog i desnog otvorenog kraja.

Mat bijela	Anodizirani aluminij	Imitacija nehrđajućeg čelika	Mat crna
F002297	F002291	F002294	F002300

### ③ RiexTouch XG20 Gola vanjski kut



● Anodizirani aluminij    ● Imitacija nehrđajućeg čelika    ● Mat crna

○ Mat bijela

Mat bijela	Anodizirani aluminij	Imitacija nehrđajućeg čelika	Mat crna
F002298	F002292	F002295	F002301

### ④ RiexTouch XG20 Gola unutarnji kut



● Anodizirani aluminij    ● Imitacija nehrđajućeg čelika    ● Mat crna

○ Mat bijele boje

Mat bijela	Anodizirani aluminij	Imitacija nehrđajućeg čelika	Mat crna
F002299	F002293	F002296	F002302

# RiexTouch XG20 Gola C oblik

## Ⓢ RiexTouch XG20 Gola C profil



○ Mat bijela

● Anodizirani  
aluminij● Imitacija  
nehrđajućeg  
čelika

● Mat crna

Horizontalni sustav Gola.  
Držač profila na str. 4.86.

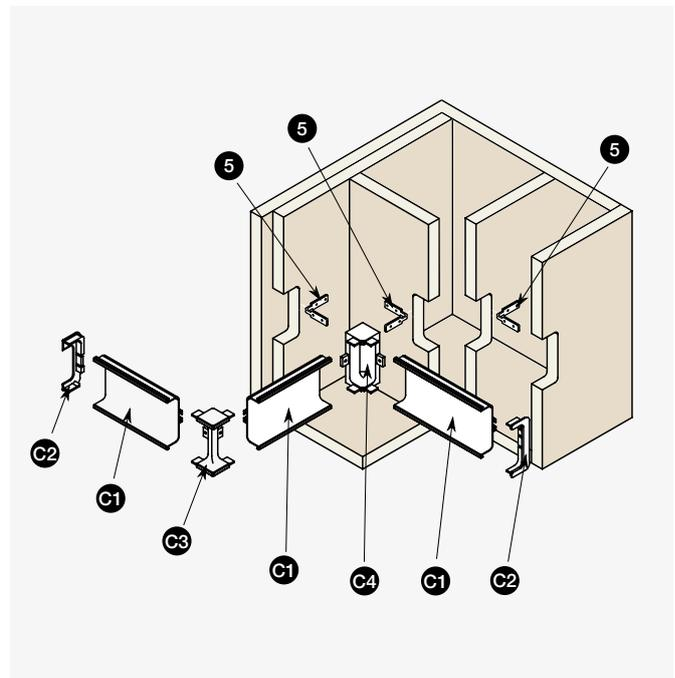
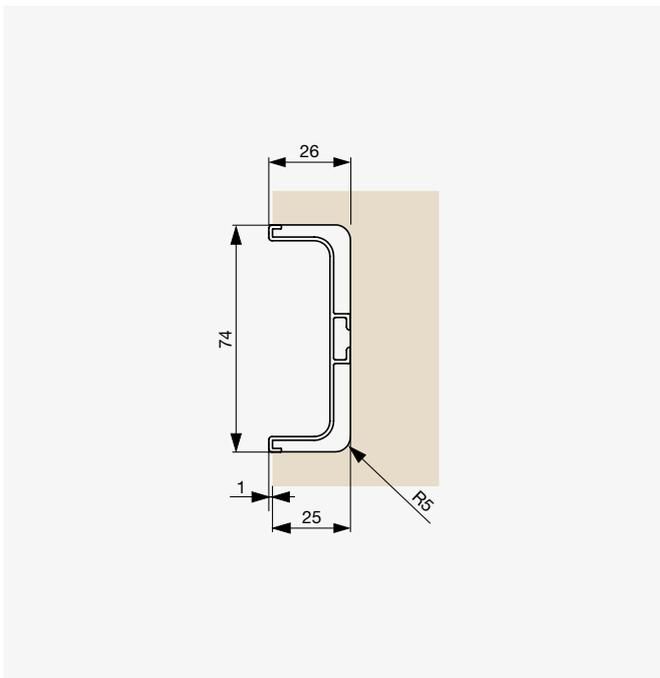

Duljina [mm]	Mat bijela	Anodizirani aluminij	Imitacija nehrđajućeg čelika	Mat crna
2900	F002289	F002287	F002288	F002290

04

**02 RiexTouch XG20 Gola otvoreni završeci**



● Anodizirani aluminij    ● Imitacija nehrđajućeg čelika    ● Mat crna

Set lijevog i desnog otvorenog kraja.

○ Mat bijela	Anodizirani aluminij	Imitacija nehrđajućeg čelika	Mat crna
F002309	F002303	F002306	F002312

**03 RiexTouch XG20 Gola vanjski kut**



● Anodizirani aluminij    ● Imitacija nehrđajućeg čelika    ● Mat crna

○ Mat bijela	Anodizirani aluminij	Imitacija nehrđajućeg čelika	Mat crna
F002310	F002304	F002307	F002313

**04 RiexTouch XG20 Gola unutarnji kut**





● Anodizirani aluminij    ● Imitacija nehrđajućeg čelika    ● Mat crna

○ Mat bijela	Anodizirani aluminij	Imitacija nehrđajućeg čelika	Mat crna
F002311	F002305	F002308	F002314

# Pribor za RiexTouch XG20 Gola

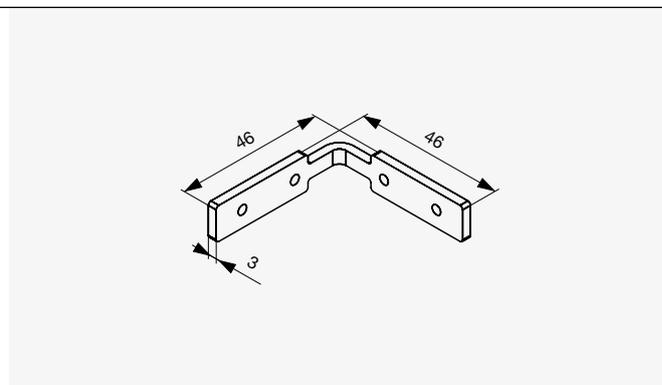
## ⑤ Nosač za profil RiexTouch XG20 Gola



Šifra

F002315

# RiexTouch XG10 Gola

04

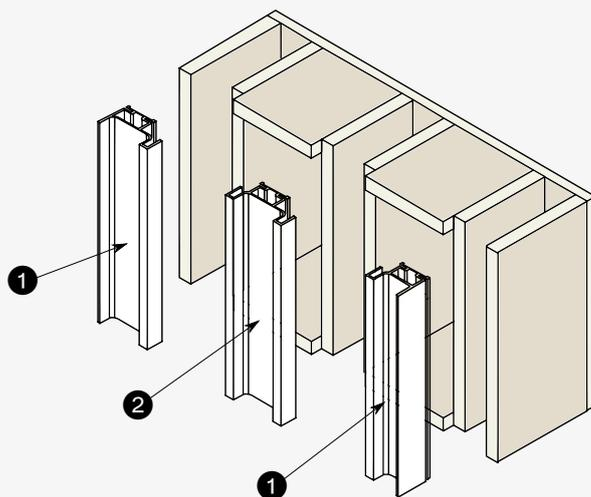

## 1 RiexTouch XG10 Gola Vertikalni bočni profil



○ Mat bijela



● Anodizirani aluminij



● Imitacija nehrđajućeg čelika



● Mat crna

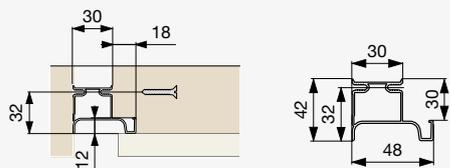

Duljina [mm]	Mat bijela	Anodizirani aluminij	Imitacija nehrđajućeg čelika	Mat crna
2900	F002746	F002744	F002745	F002747



## ② RiexTouch XG10 Gola Vertikalni središnji profil



○ Mat bijela



● Anodizirani  
aluminij



● Imitacija  
nehrđajućeg  
čelika



● Mat crna

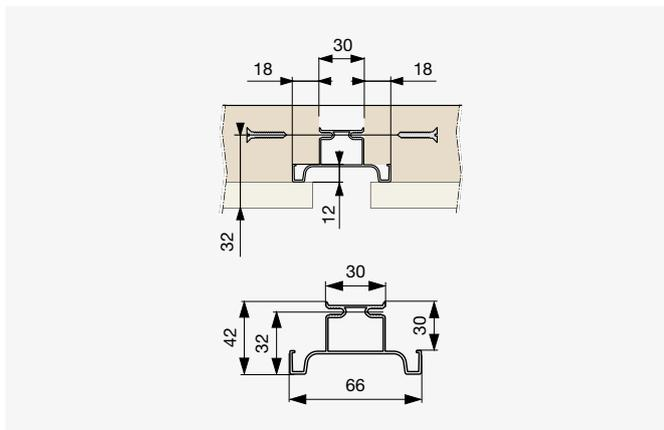

Duljina [mm]	Mat bijela	Anodizirani aluminij	Imitacija nehrđajućeg čelika	Mat crna
2900	F002750	F002748	F002749	F002751

## ③ RiexTouch XG10 Gola Horizontalni profil vrata za gornje ormare



○ Mat bijela



● Anodizirani  
aluminij



● Imitacija  
nehrđajućeg  
čelika



● Mat crna

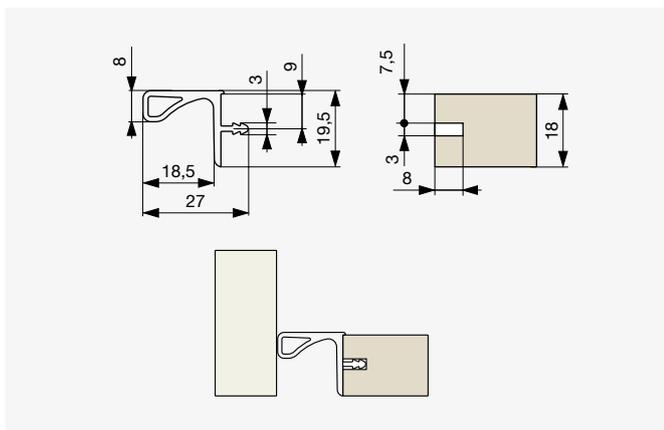

Duljina [mm]	Mat bijela	Anodizirani aluminij	Imitacija nehrđajućeg čelika	Mat crna
2900	F002754	F002752	F002753	F002755

01  
02  
03  
04  
05  
06  
07  
08  
09  
10  
11  
12  
13  
14  
15  
16  
17  
18

# Vješalice

04



## ● Citterio Giulio XV39 vješalica



● Polirana francuska bronca



● Polirano krom

Isto dizajnirana ručkica i gumb na str. 4.21 i 4.22.

Polirana  
francuska bronca

F003263

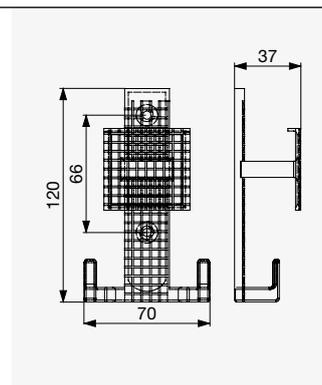

Polirano  
krom

F003262

## ● Citterio Giulio XV40 kuka



● Polirano krom



● Polirana francuska bronca

Isto dizajnirana ručkica i gumb na str. 4.21 i 4.22.

Polirano  
krom

F003264

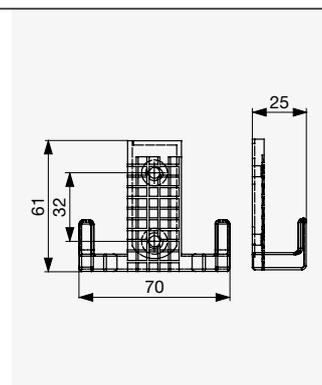

Polirana  
francuska bronca

F003265

## ● Citterio Giulio XV43 kuka

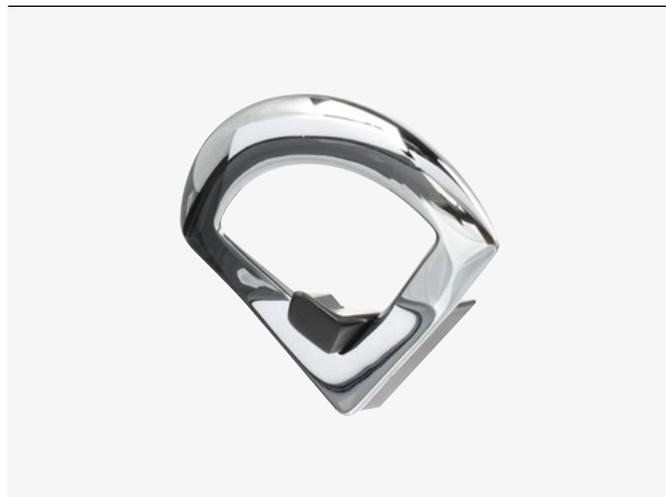

● Polirano krom

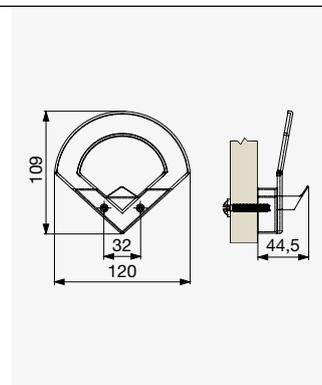

Polirano  
krom

F003270

## ● Citterio Giulio XV42 kuka

04



● Patinirano željezo

Patinirano  
željezo

F003269

● Prirodna  
broncaPrirodna  
bronca

F003268

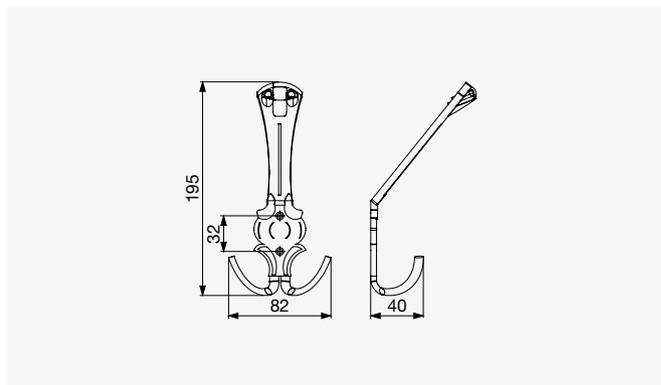

## ● Citterio Giulio XV41 kuka



● Patinirano željezo

Patinirano  
željezo

F003267

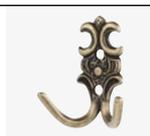
● Prirodna  
broncaPrirodna  
bronca

F003266

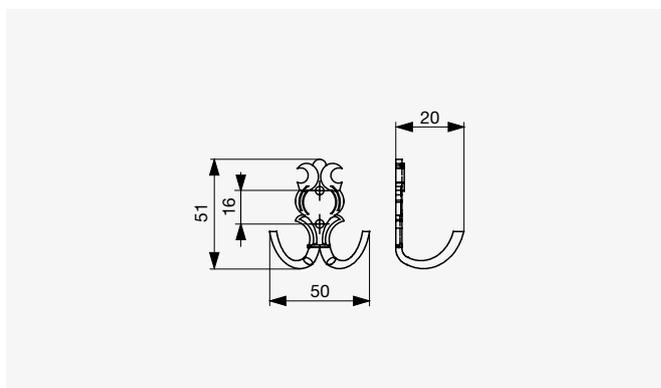

### ● RiexTouch XV23 kuka

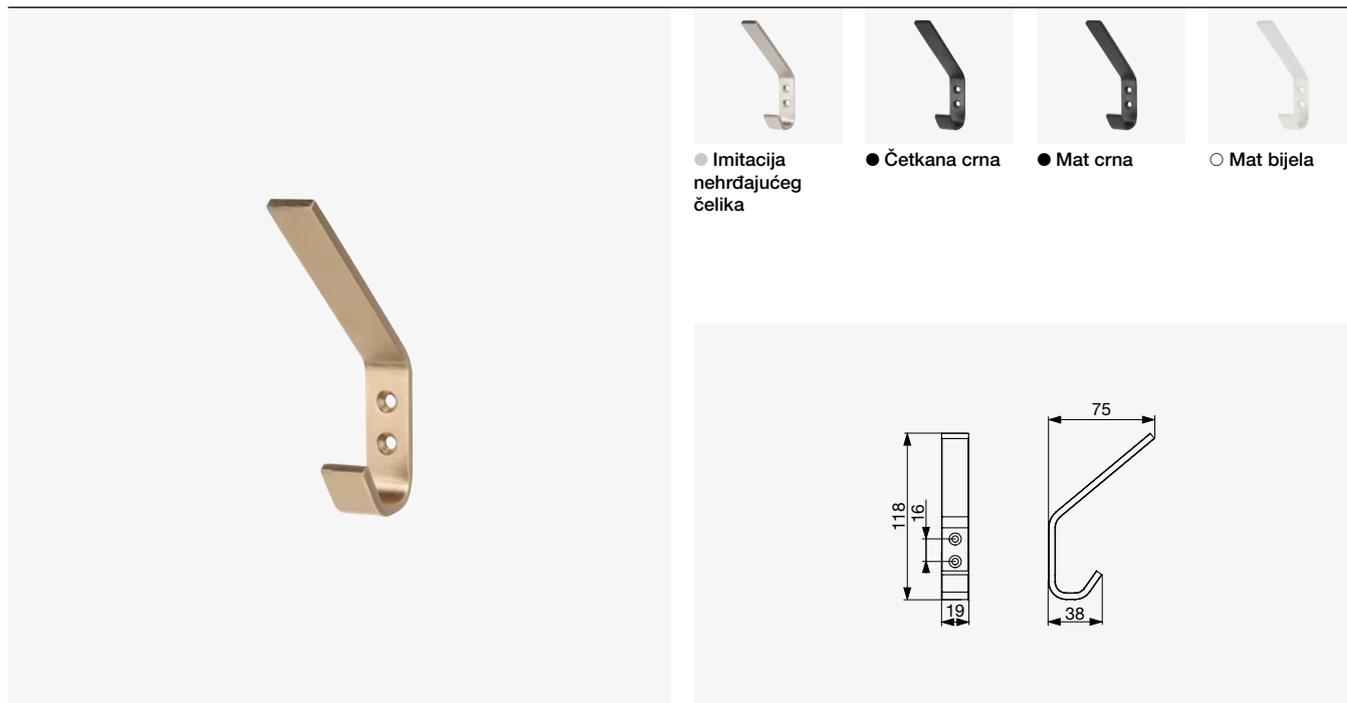

● Brušeno zlato

Polirano zlato	Imitacija nehrđajućeg čelika	Četkana crna	Mat crna	Mat bijela
F002458	F002456	F002457	F002635	F002636

### ● RiexTouch XV01 kuka

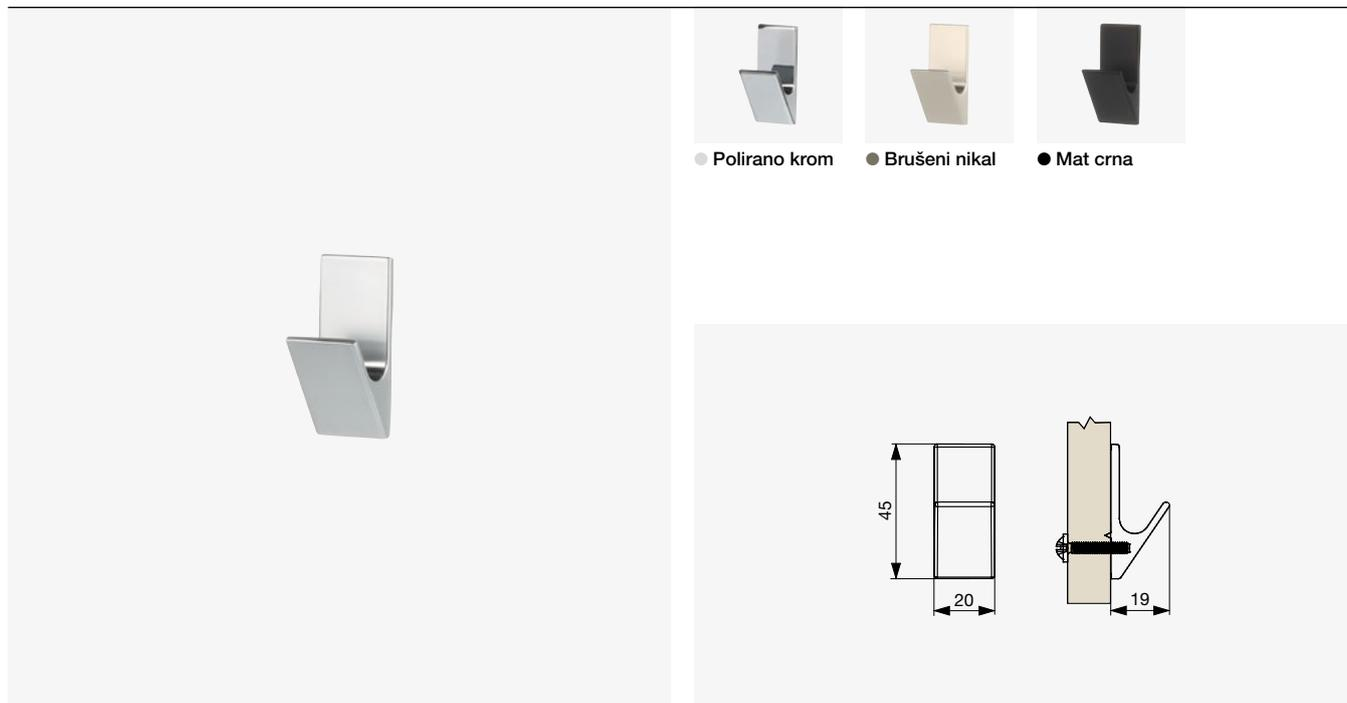

● Mat krom

Mat krom	Polirano krom	Brušeni nikal	Mat crna
F002483	F002482	F002484	F002485

01  
02  
03  
04  
05  
06  
07  
08  
09  
10  
11  
12  
13  
14  
15  
16  
17  
18

04

### ● RiexTouch XV14 kuka



● Mat crna

Mat crna	Polirano krom	Mat krom	Brušeni nikal
F002448	F002445	F002446	F002447

### ● RiexTouch XK09 kuka



● Mat antracit

Gumb istog dizajna na str. 4.58.

Mat antracit	Polirano zlato	Mat krom
F002594	F002593	F002595

### ● RiexTouch XV25 vješalica

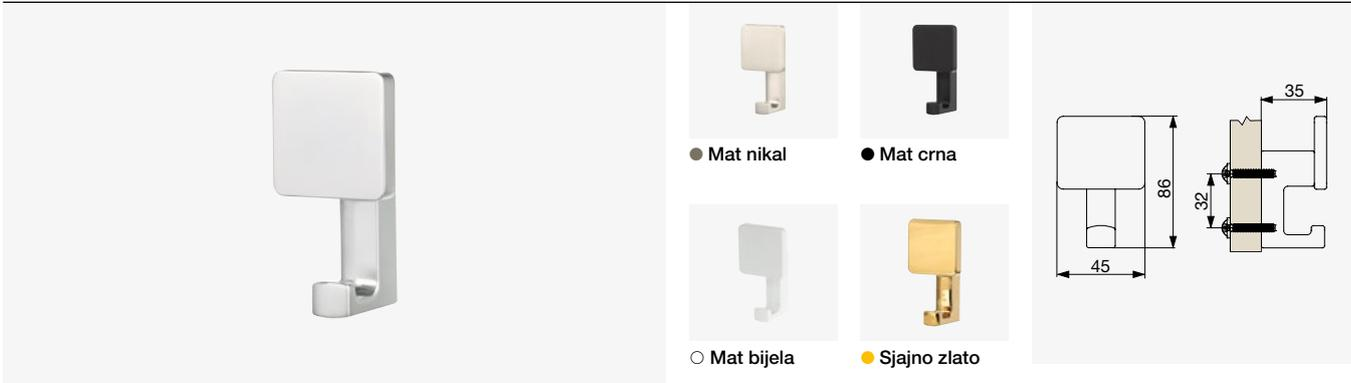

● Mat krom

Mat krom	Mat nikal	Mat crna	Mat bijela	Sjajno zlato
F002464	F002463	F002465	F002466	F002467

## ● RiexTouch XV34 kuka





● Brušeni nikal   ● Mat krom   ● Mat crna   ○ Mat bijela

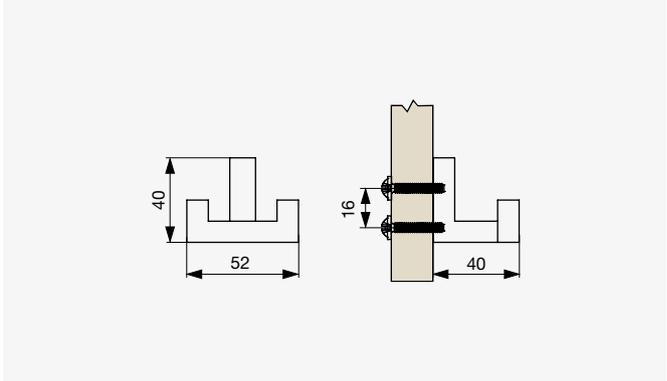

● Polirano krom

Poliran krom	Poliran nikal	Mat krom	Mat crna	Mat bijela
F002478	F002477	F002479	F002480	F002481

## ● RiexTouch XV33 kuka





● Brušeni nikal   ● Mat krom   ● Mat crna   ○ Mat bijela

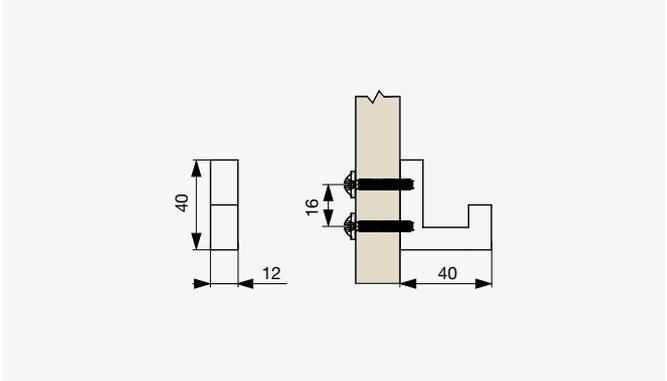

● Polirano krom

Poliran krom	Poliran nikal	Mat krom	Mat crna	Mat bijela
F002473	F002472	F002474	F002475	F002476

04

### ⊕ RiexTouch XV28 kuka

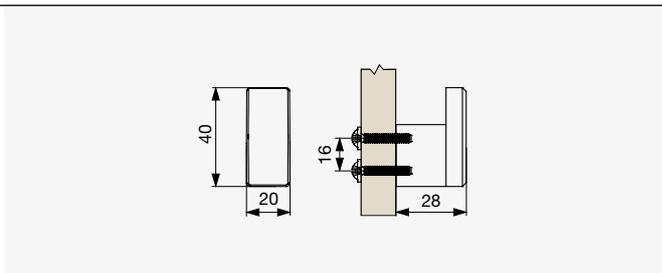
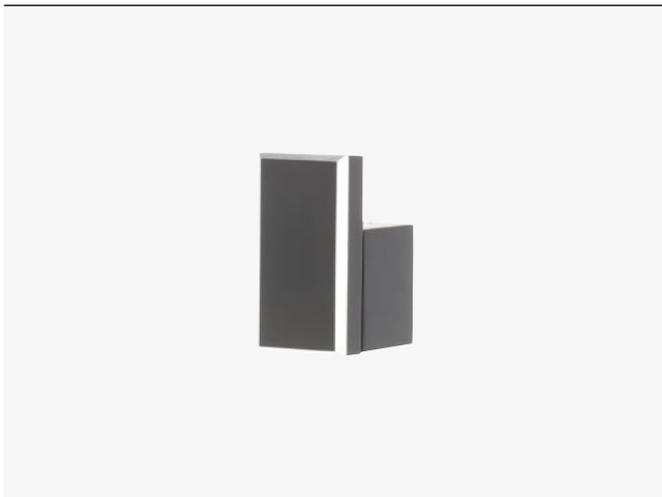

Nosač istog dizajna na str. 4.43. Isto oblikovana ručkica na str. 4.57.

Mat  
crna

F002468

● Mat crna

### ⊕ RiexTouch XV38 kuka

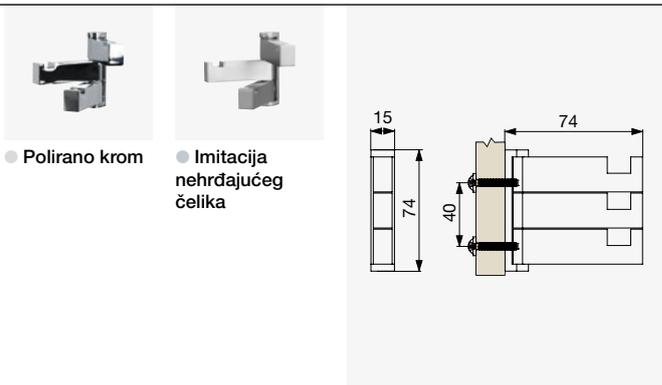

Mat  
nikal

F002644

Polirano  
krom

F002643

Imitacija  
nehrđajućeg  
čelika

F007556

● Mat nikal

### ⊕ RiexTouch XV35 kuka

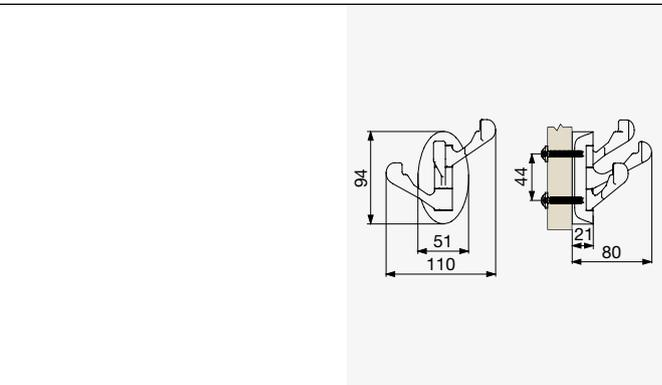

Mat  
nikal

F002634

● Mat nikal



## ● RiexTouch XV32 kuka



● Mat krom

● Brušeni nikal

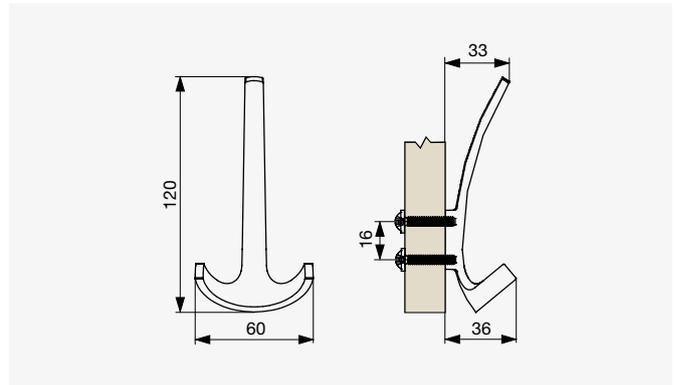

● Mat crna

Mat  
crna

F002471

Mat  
krom

F002469

Brušeni  
nikal

F002470

## ● RiexTouch XV21 kuka



● Mat krom

● Polirano krom

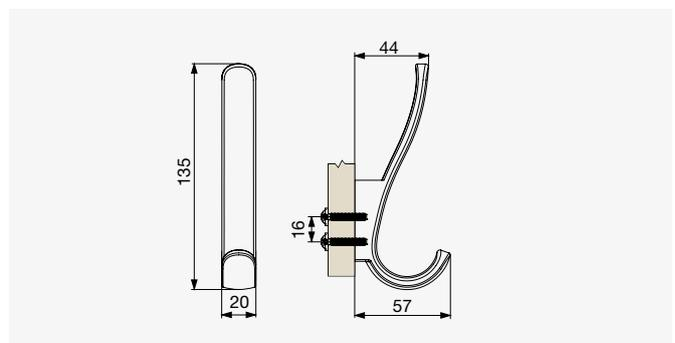

● Mat nikal

Mat  
nikal

F002454

Mat  
krom

F002453

Polirano  
krom

F002455

04

### ➤ RiexTouch XV19 kuka



● Mat krom      ● Mat nikal      ● Mat crna

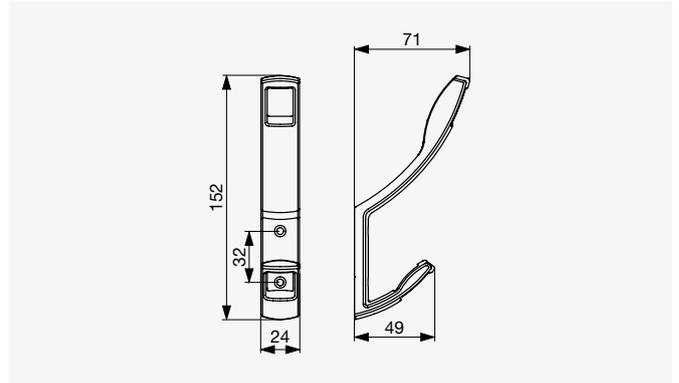

● Polirano krom

Poliran krom	Mat krom	Mat nikal	Mat crna
F002452	F002449	F002450	F002451

### ➤ RiexTouch XV24 kuka



● Mat krom      ● Polirano krom      ● Polirano zlato

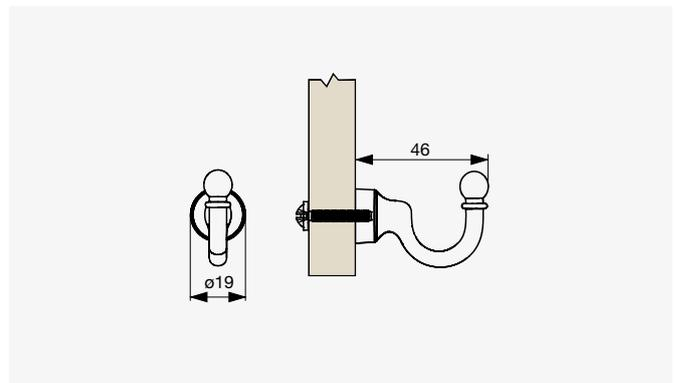

● Mat nikal

Mat nikal	Mat krom	Poliran krom	Poliran zlato
F002459	F002460	F002461	F002462

### ● RiexTouch XV04 kuka

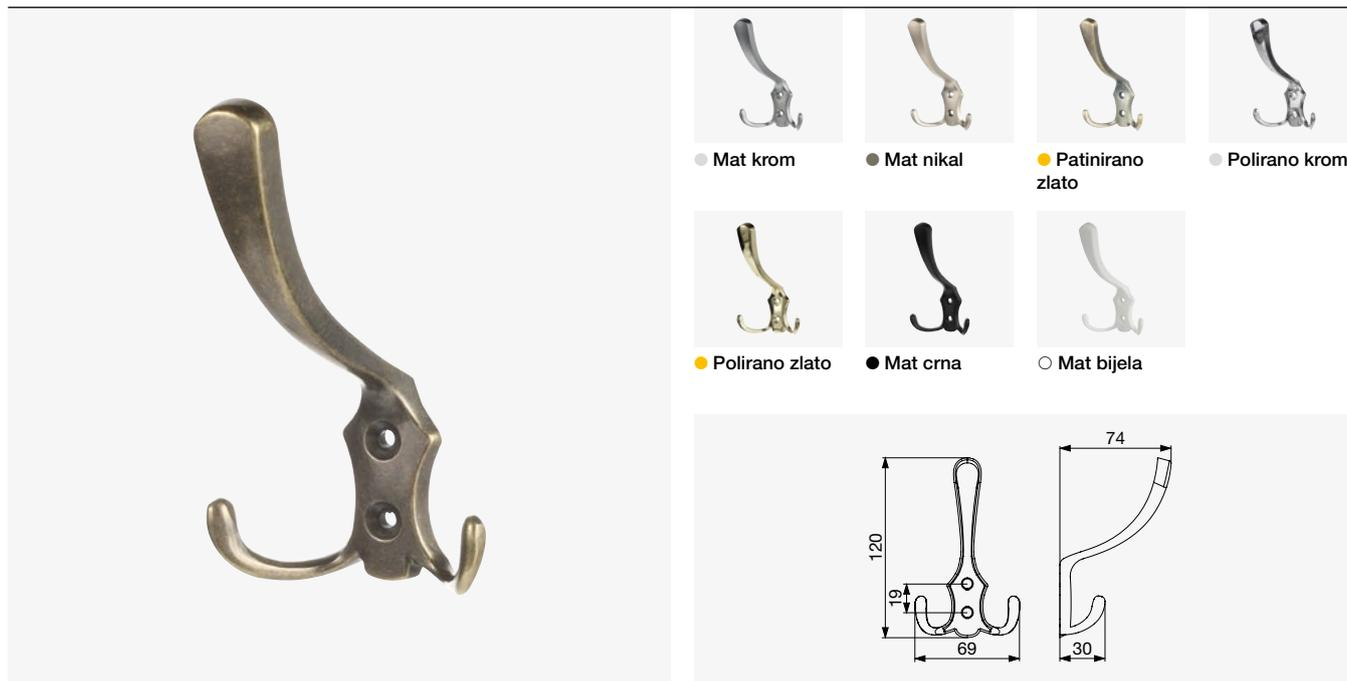

● Patinirana bronca

Patinirana bronca	Mat krom	Mat nikal	Patinirano zlato	Polirano krom	Polirano zlato	Mat crna	Mat bijela
F002426	F002419	F002420	F002421	F002422	F002423	F002424	F002425

### ● RiexTouch XV03 kuka

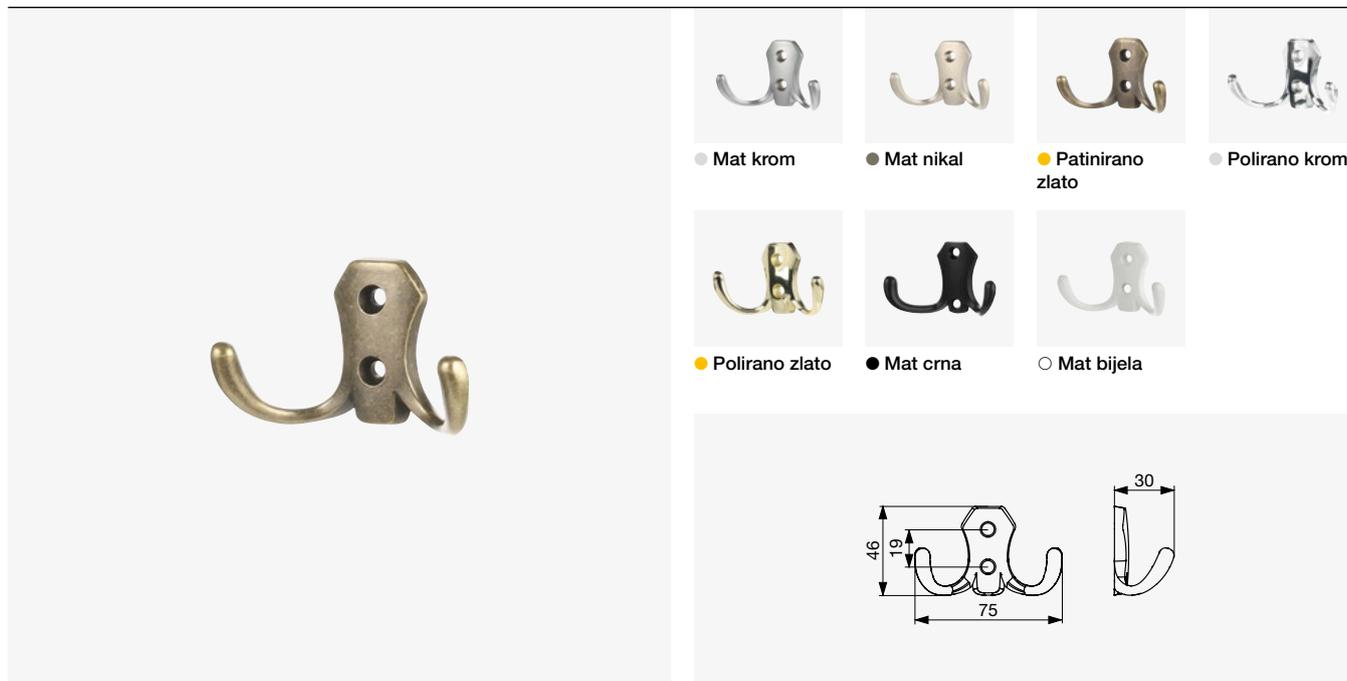

● Patinirana bronca

Patinirana bronca	Mat krom	Mat nikal	Patinirano zlato	Polirano krom	Polirano zlato	Mat crna	Mat bijela
F002418	F002411	F002412	F002413	F002414	F002415	F002416	F002417

01  
02  
03  
04  
05  
06  
07  
08  
09  
10  
11  
12  
13  
14  
15  
16  
17  
18

04

### ● RiexTouch XV07 kuka



● Polirano krom ● Mat krom

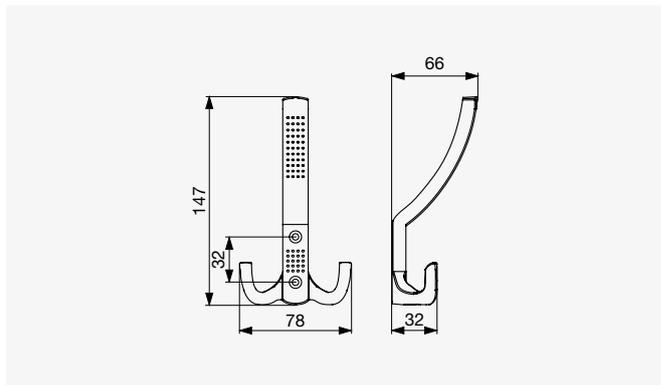

● Mat nikal

Mat  
nikal

F002432

Polirano  
krom

F002430

Mat  
krom

F002431

### ● RiexTouch XV05 kuka



● Polirano krom ● Mat krom

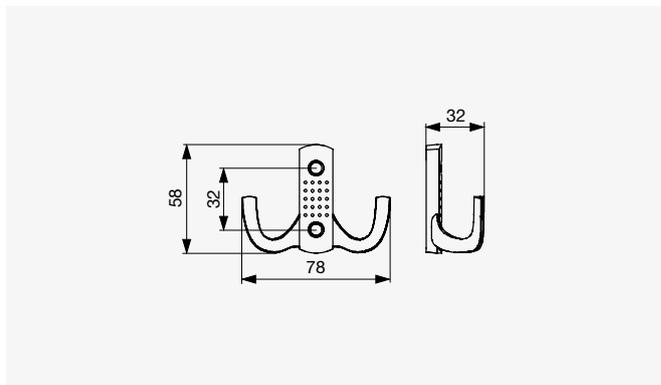

● Mat nikal

Mat  
nikal

F002429

Polirano  
krom

F002427

Mat  
krom

F002428

## ● RiexTouch XV11 kuka



● Mat krom

● Mat nikal

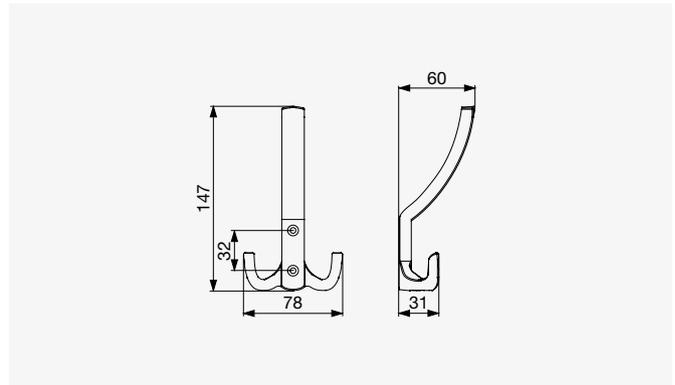

● Polirano krom

Polirano  
krom

F002436

Mat  
krom

F002437

Mat  
nikal

F002438

## ● RiexTouch XV09 kuka



● Mat krom

● Mat nikal

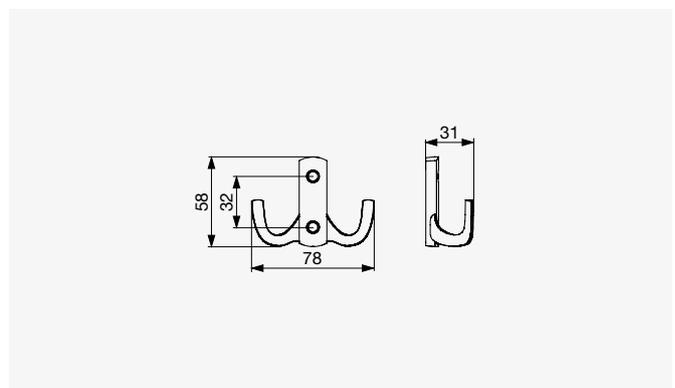

● Polirano krom

Polirano  
krom

F002433

Mat  
krom

F002434

Mat  
nikal

F002435

04

### ⊕ RiexTouch XV13 kuka

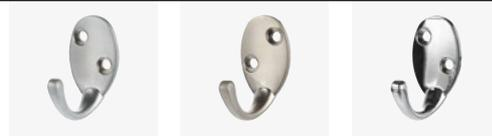

● Mat krom ● Mat nikal ● Polirano krom

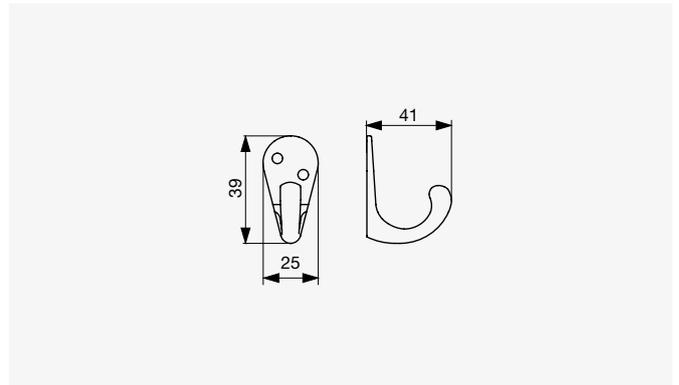

● Mat crna

Mat crna	Mat krom	Mat nikal	Poliran krom
F002640	F002637	F002638	F002639

### ⊕ RiexTouch XV31 kuka

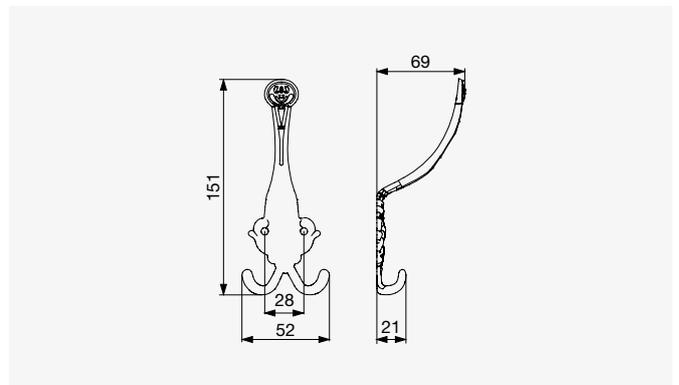
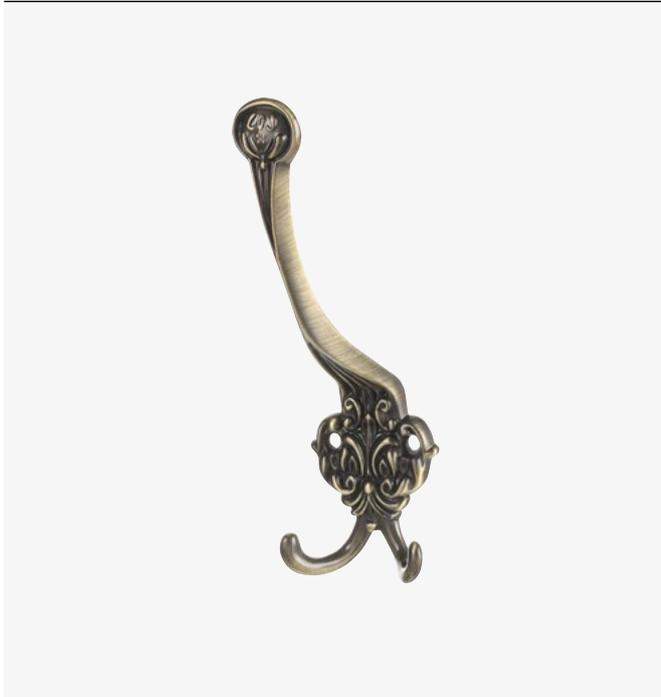

● Patinirano zlato

Patinirano zlato  
F002642

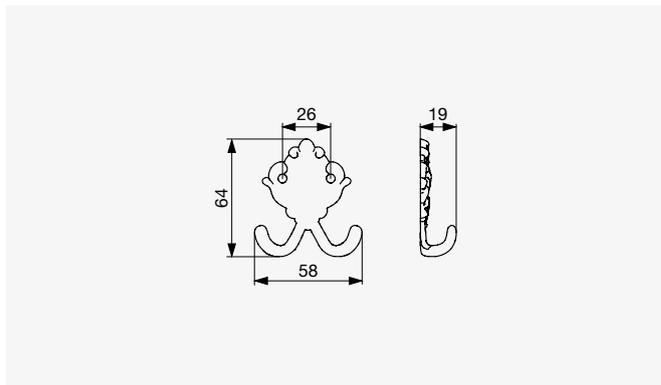
**● RiexTouch XV30 kuka**

● Patinirano zlato

Patinirano  
zlato

F002641



04

**RiexTouch XV02 kuka** **ECONOMY**

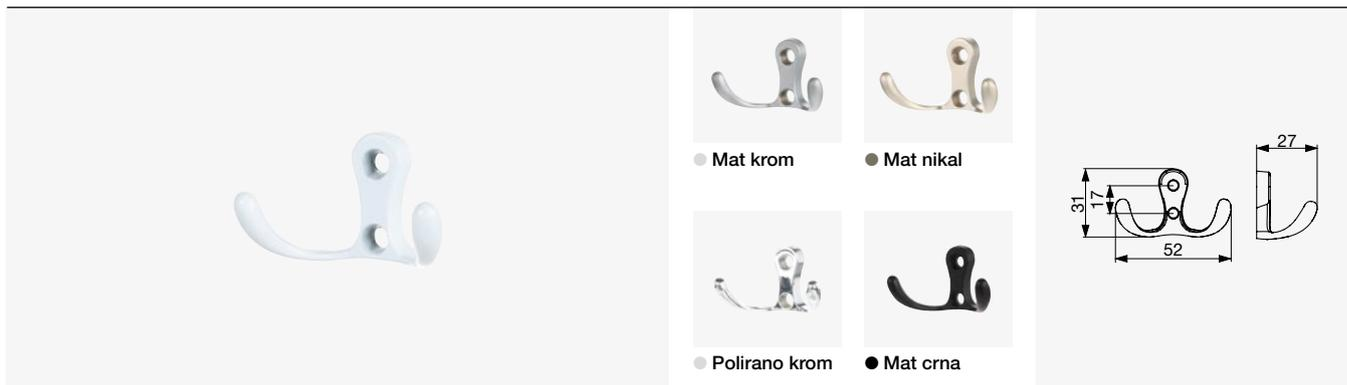

○ Sjajna bijela

Sjajna bijela	Mat krom	Mat nikal	Poliran krom	Mat crna
F002410	F002406	F002407	F002408	F002409

**RiexTouch XV08 kuka** **ECONOMY**

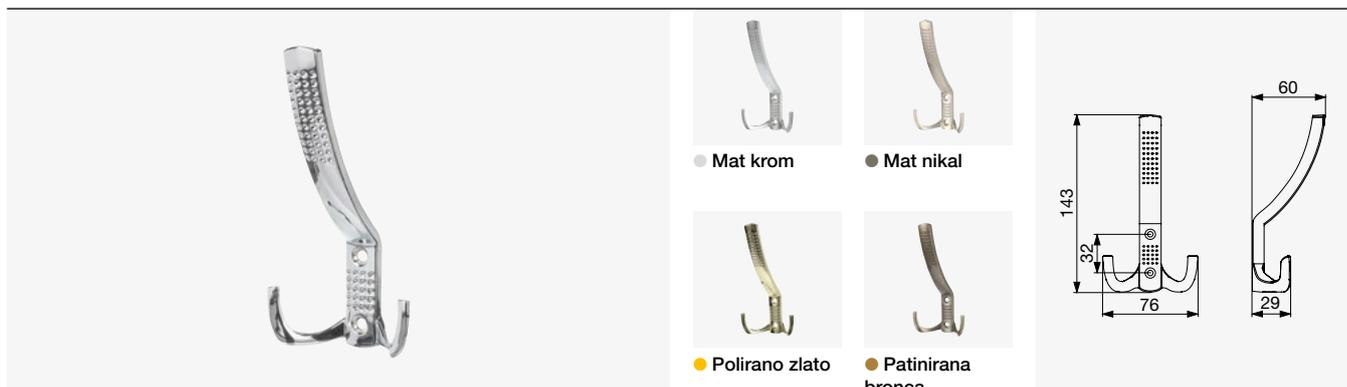

● Polirano krom

Polirano krom	Mat krom	Mat nikal	Polirano zlato	Patinirana bronca
F002491	F002492	F002493	F002494	F002495

**RiexTouch XV06 kuka** **ECONOMY**

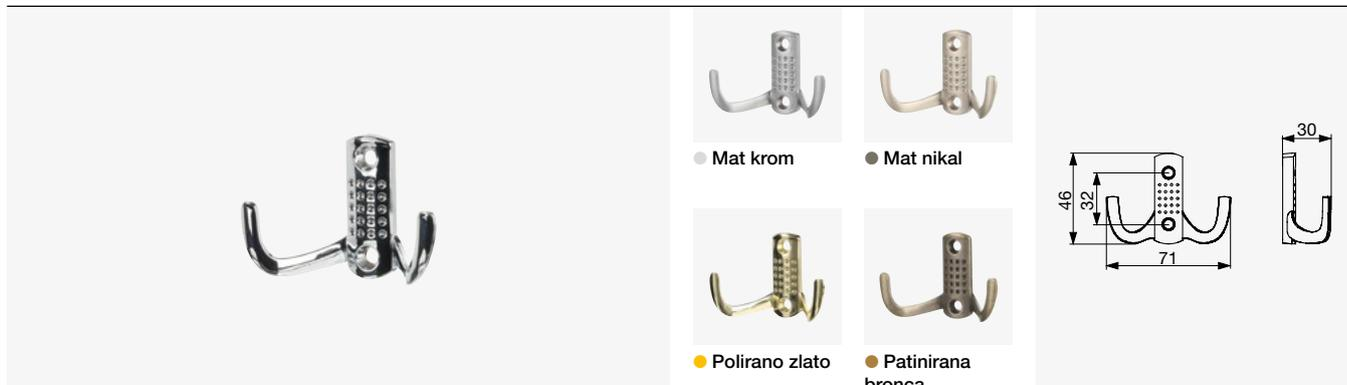

● Polirano krom

Poliran krom	Mat krom	Mat nikal	Poliran zlato	Patinirano bronca
F002486	F002487	F002488	F002489	F002490



## ➤ RiexTouch XV12 kuka **ECONOMY**



● Polirano krom ● Mat krom

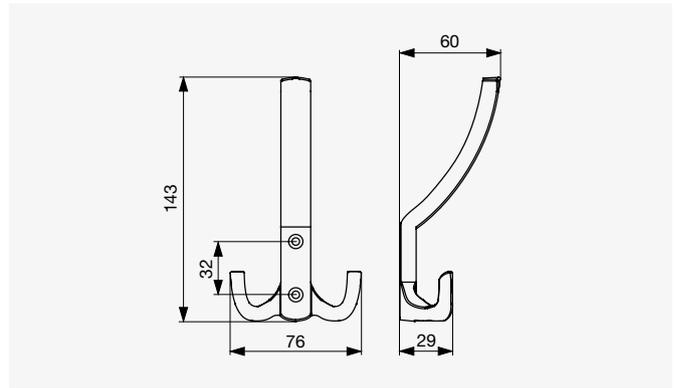

● Mat nikal

Mat nikal	Polirano krom	Mat krom
F002442	F002443	F002444

## ➤ RiexTouch XV10 kuka **ECONOMY**



● Polirano krom ● Mat krom

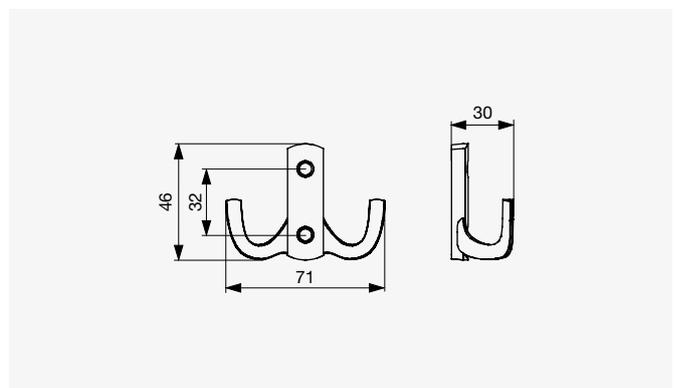

● Mat nikal

Mat nikal	Polirano krom	Mat krom
F002439	F002440	F002441

# Noge za namještaj, vodilice i kotačići

Noge za namještaj, kotačići i vodilice su vrsta ugradbene opreme koja je vrlo funkcionalna, a također može poboljšati izgled namještaja različitim oblicima, materijalima i bojama. U ovom odjeljku nalaze se različite vrste plastičnih nogu za kuhinjske elemente koje su podesive po visini i omogućuju pričvršćivanje postolja, a možete birati i između mnogih drugih vrsta podesivih nogu za različite vrste ormara. U posebnom dijelu nalazi se i širok izbor dizajnerskih nogu, izrađenih od različitih materijala, u različitim veličinama, bojama i obradama. Važan dio toga su dizajnerski kotačići za namještaj i kotačići za tehničku upotrebu koji imaju različite nosivosti, a njihova baza izrađena je od materijala pogodnih za kretanje po tvrdim ili mekim podovima. U ovom dijelu nudimo i vodilice za namještaj.



---

● Kuhinjske podesive noge	5.3
● Podesive noge i vodilice za namještaj	5.9
Vodilice za noge namještaja	5.9
Vodilice	5.14
● Noge za namještaj	5.16
● Plastične noge za namještaj	5.29
● Drvene noge za namještaj	5.35
● Kotačići za namještaj	5.37

---

# Kuhinjske podesive noge

05

- Konstrukcija za veliku nosivost
- Idealno za donje kuhinjske elemente
- Po želji i za korištenje u garderobi
- 2 ili 3 dijela kompozicije



## ⊕ Riex GK50 Kuhinjske noge



- Sastoji se od tri dijela
- 4 visine
- Robustan dizajn
- Nosivost 250 kg po komadu
- Mogućnost postavljanja iz unutrašnjosti ormara

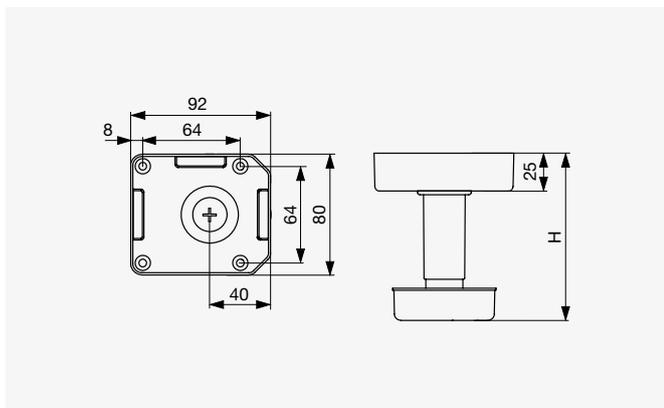

Visina H [mm]	Kod	Podešavanje visine [mm]
60	F000339	-10 / +15
100	F000341	-15 / +25
120	F000342	-25 / +25
150	F000343	-25 / +45

## ⊕ Riex GK50 Prihvatnik cokla za kuhinjske noge

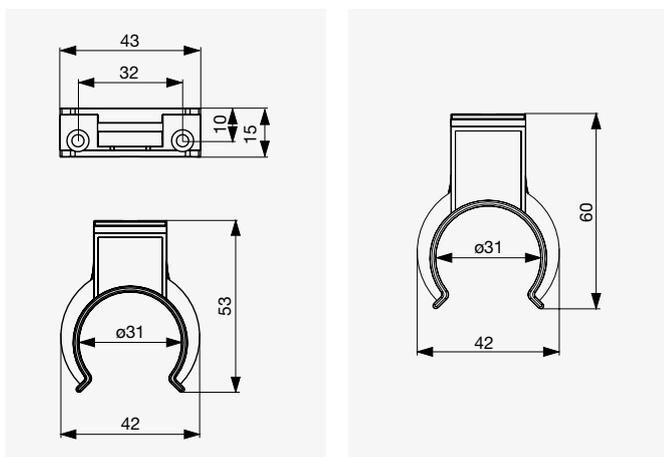

⊕ F000344

⊕ F002927

Prihvatnik cokla	Kod
Za vijak	F000344
Za plastičnu podlogu	F002927

## ● Koromač Samson Kuhinjske noge

05



① Vijčanje



① Sa klinovima



- Sklopiva konstrukcija – jednostavan transport i manipulacija ormaricom
- 2 visine
- Vrste veze
  - Za vijke
  - Brza montaža s klinom 2x ø8 mm i 1x ø10 mm
- Robustan dizajn
- Nosivost 350 kg po komadu

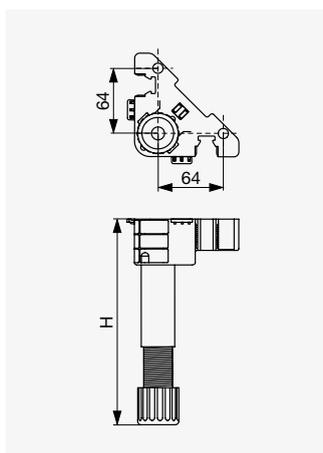

① F005027, F005028

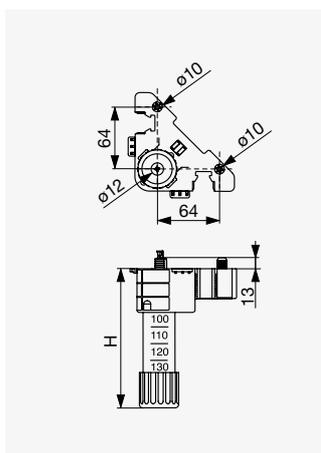

① F005029, F005030

Povezava vrsta	Visina H [mm]	Kod	Podešavanje visine [mm]
Uvrtanje	100	F005027	-10 / +65
	150	F005028	-10 / +60
S tiplama	100	F005029	-10 / +65
	150	F005030	-10 / +60

## ● Dodaci za Samson komorač



Vrsta	Kod
Brzi	F005031
Samoljepljiva	F005032

## ⊕ Riex GK40 Kuhinjske noge



- Sastoji se od tri dijela
- 4 visine
- Tanka konstrukcija s velikom nosivošću od 200 kg

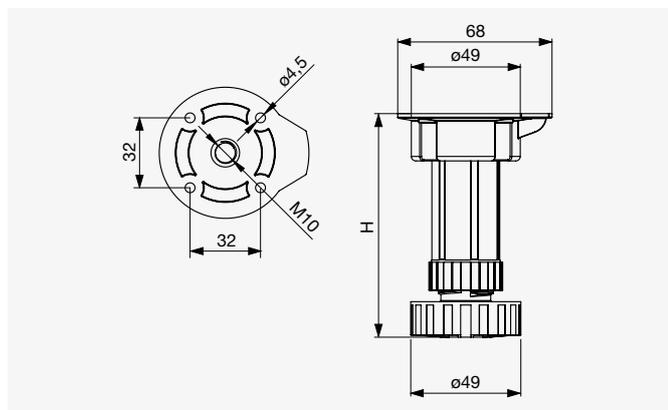

Visina H [mm]	Kod	Podšavanje visine [mm]
80	F002793	
100	F002794	
120	F002795	-5/+15
150	F002796	

## ⊕ Riex GK40 Dodaci za kuhinjske noge



⊕ F002798



⊕ F002797



⊕ F003099



⊕ F003100

Vrsta pribora	Kod
Vijčani prihvatnik	F002798
Prihvatnik za plastičnu bazu	F002797
Poklopac za vijak bijele boje	F003099
Metalni vijak M10 × 35*	F003100

\* Može se koristiti za stolove debljine do 25 mm.

01  
02  
03  
04  
05  
06  
07  
08  
09  
10  
11  
12  
13  
14  
15  
16  
17  
18

## ⊕ Riex GK33 Kuhinjske noge – cijev



- Za kombinaciju s bazama GK33
- Cijeli sklop čini 3 dijela noge
- 4 visine
- Nosivost 200 kg

05

⊕ F005499, F005500, F005501, F005502

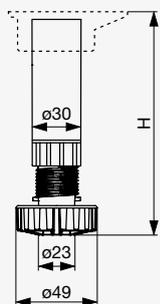

Visina H [mm]	Kod	Podešavanje visine [mm]
85	F005499	
100	F005500	
120	F005501	-5 / +15
150	F005502	

## ⊕ Riex GK33 Kuhinjske noge – podnožje



⊕ F005503



⊕ F005504

- Kombinacija s GK33 cijevima

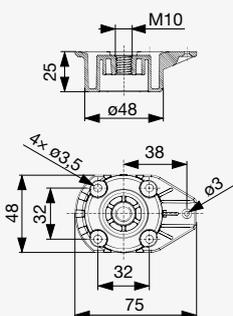

⊕ F005503

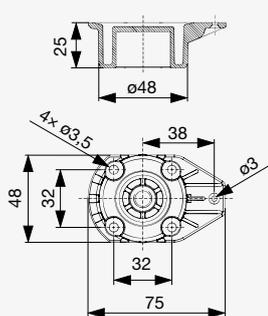

⊕ F005504

Osnovne vrste	Kod
S unutarnjim navojem M10	F005503
Ravna strana	F005504



## ⊕ Riex GK30 Kuhinjske noge



- Sastoji se od 2 dijela
- 3 visine
- Cjelokupni dizajn s velikom nosivošću od 200 kg

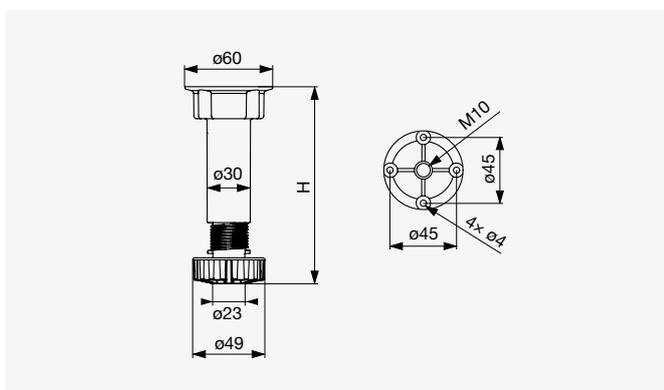

Visina H [mm]	Kod	Podešavanje visine [mm]
100	F000932	
120	F000933	-5 / +15
150	F000934	

## ⊕ Riex GK30 / 33 Dodaci za kuhinjske noge



⊕ F000938



⊕ F000937

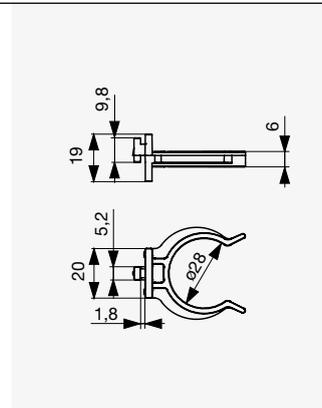
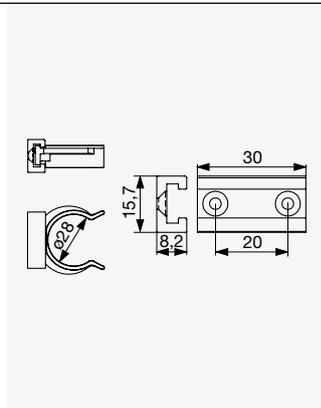

⊕ F004521

Vrsta pribora	Kod
Za vijak	F000938
Za plastičnu bazu	F000937
Vijak M10 × 38*	F004521

\* Može se koristiti za stolove debljine do 25 mm.

# Podesive noge i vodilice za namještaj

05

- Skriveno ili vidljivo rješenje
- Idealno za različite vrste namještaja

## ➤ Riex GL13 podesive noge

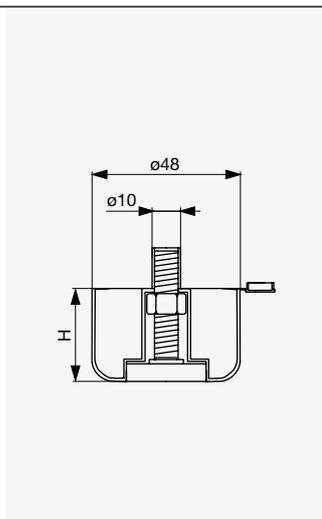

- 3 različite visine
- Poklopac s vijkom

Visina H [mm]	Kod	Podešavanje visine [mm]
17	F002003	
27	F002004	+11
44	F002005	

## ➤ Podesiva noga Riex GA40

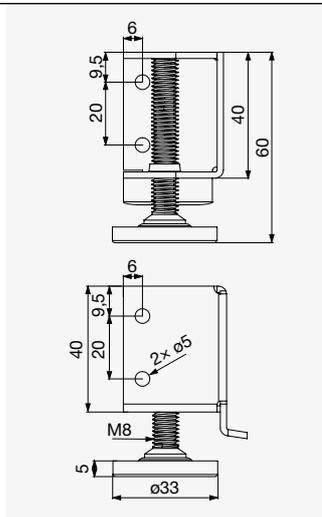

Visina [mm]	Kod	Podešavanje visine [mm]
60	F003043	+25

## ⊕ Riex GA20 podesiva kutna noga



- Za bočnu ploču 25 mm

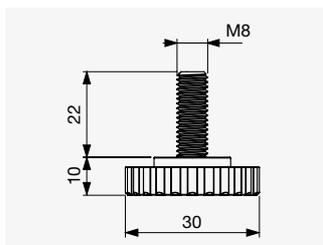
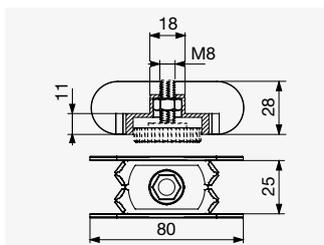

⊙ F002837

⊙ F002836

Tip	Kod	Podešavanje visine [mm]
Adapter za rub 25 mm	F002837	15
Vijak M8 × 22 mm	F002836	

## ⊕ Riex GA18 podesiva kutna noga



- Za bočnu ploču 18 mm

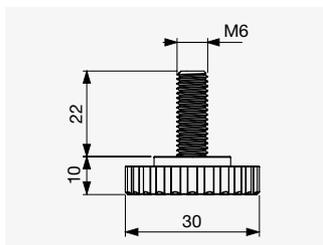
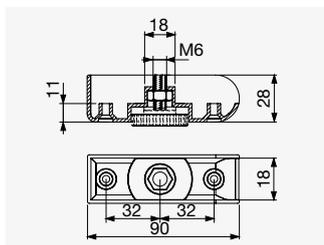

⊙ F002833

⊙ F002834

Tip	Kod	Podešavanje visine [mm]
Adapter za 18 mm	F002833	+10
Vijak M6 × 22 mm	F002834	

## ⊕ Riex GA25 podesiva kutna noga



- Za bočnu ploču 25 mm

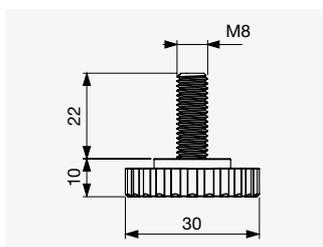
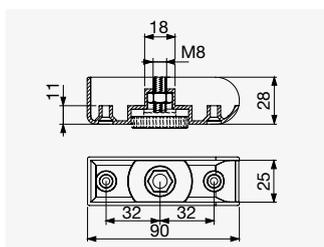

⊙ F002835

⊙ F002836

Tip	Kod	Podešavanje visine [mm]
Adapter za 25 mm	F002835	+15
Vijak M8 × 22	F002836	

### ⊕ Riex GA11 podesiva vijčana nogica

05

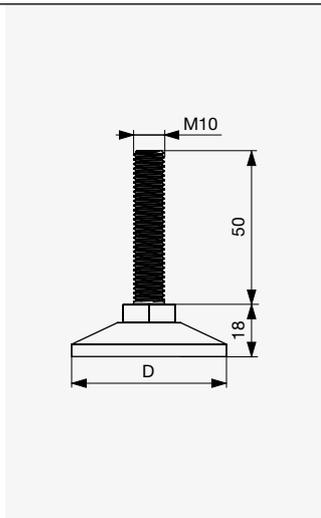

øD [mm]	Vijak [mm]	Kod	Veza za pomicanje
30	M10 × 50	F003561	Navedite
50		F003562	

### ⊕ Riex GA12 podesiva vijčana nogica

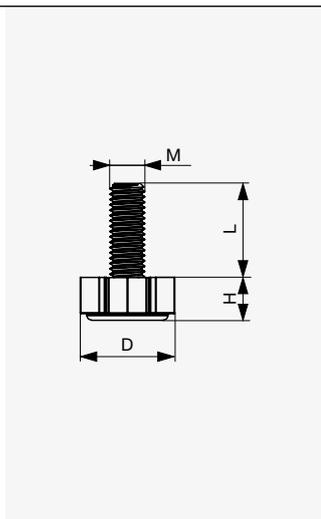

øD [mm]	Vijak [mm]	Kod	H [mm]	Veza za pomicanje
17	M6 × 22	F003564	8,5	Navedite
22	M8 × 22	F003565	10	
	M10 × 28	F003566		

### ⊕ Riex GA13 podesiva vijčana nogica

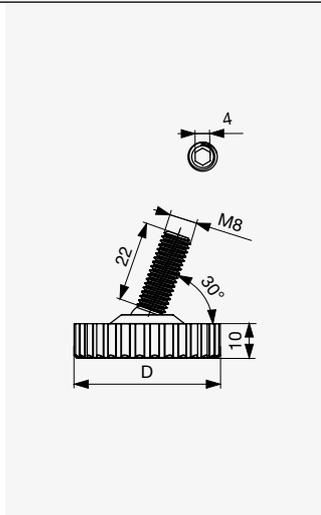

øD [mm]	Vijak [mm]	Kod	Veza za pomicanje
25	M8 × 22	F003567	Naginjući se
30		F003568	

### ⊕ Podesiva nogica Riex GA10

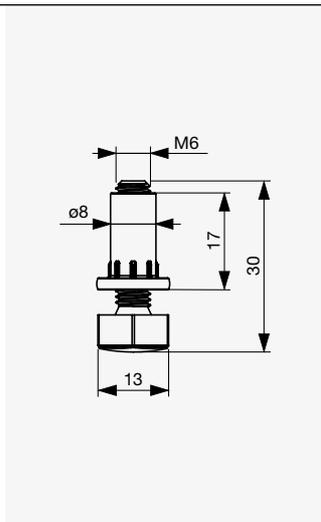

Vijak [mm]	Kod	Bušenja [mm]	Podešavanje visine [mm]
M6 × 30	F002832	D8 × 30	+15

### ⊕ Podesiva nogica Riex GA24

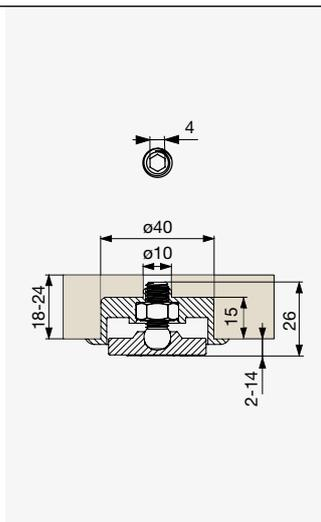

øD [mm]	Kod	Visina [mm]	Podešavanje visine [mm]	Nosivost [kg]
40	F003563	22	+12	150

### ● IF Record nivelir noga

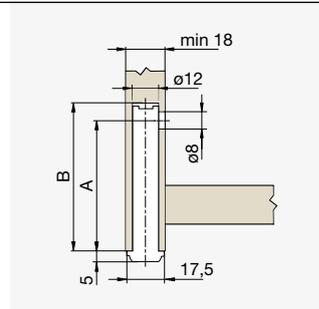
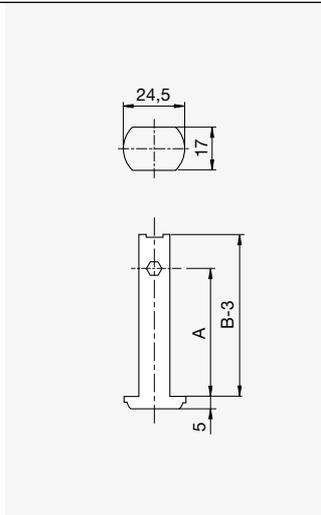

A [mm]	Kod	B [mm]	Podešavanje visine [mm]	Nosivost [kg]
52	F002722	65		
70	F002723	83	+12	150
96	F002724	109		

● IF Integrato G nivelir

05

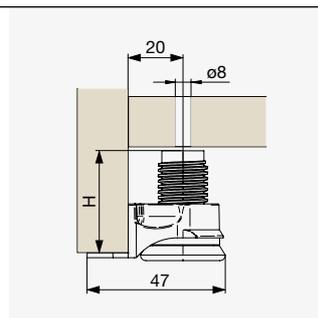
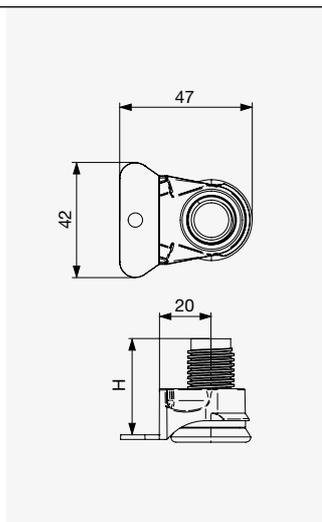

Visina H [mm]	Kod	Podešavanje visine [mm]	Nosivost [kg]
19	F002725	+12	175
37,5	F002726	+25	

● IF Integrato Z

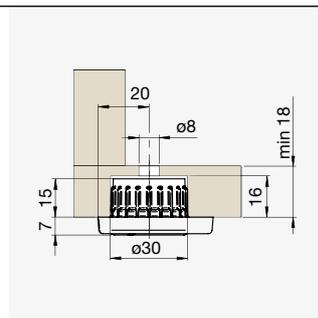
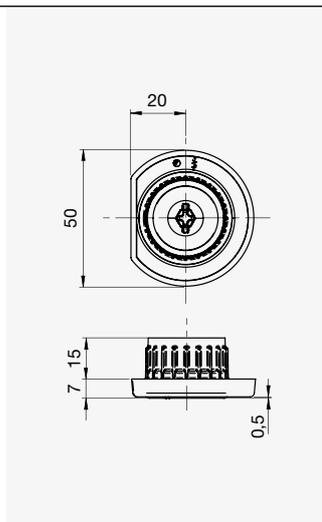

Promjer [mm]	Kod	Podešavanje visine [mm]	Nosivost [kg]
50	F002727	+10	175

● IF Ravni nivelir

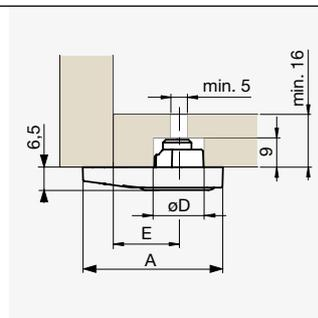
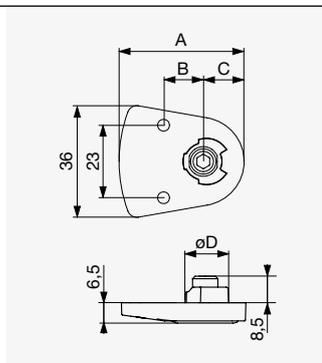

Duljina A [mm]	Kod	Podešavanje visine [mm]	Nosivost [kg]	B [mm]	C [mm]	D [mm]	E [mm]
48	F002728			20	13	12	28
40	F002729	+5	150	12,5	12	15	20

### ⊕ Riex GL10 podložak sa klinovima

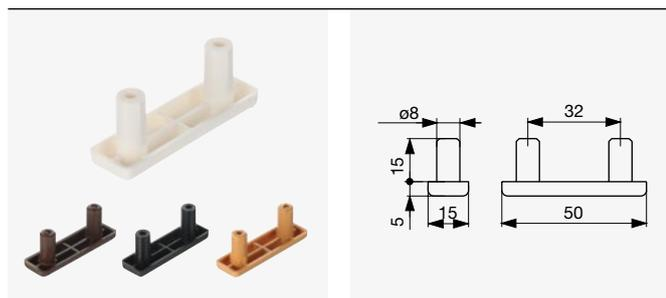

Boja	Kod
Bijela	F002953
Smeđa	F002954
Crno	F002955
Drvo bukve	F002956

### ⊕ Riex GL12 podložak za utor



Boja	Kod
Bijela	F002957
Smeđa	F002958
Crno	F002959
Drvo bukve	F002960

### ⊕ Riex GL14 podložak sa vijcima

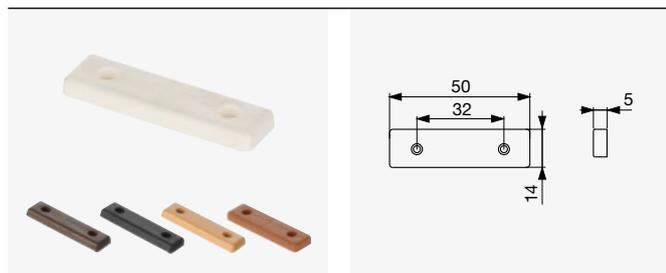

Boja	Kod
Bijela	F002961
Smeđa	F002962
Crna	F002963
Bukva	F002964
Joha	F002965

### ⊕ Riex GL15 podložak zakucavanjem

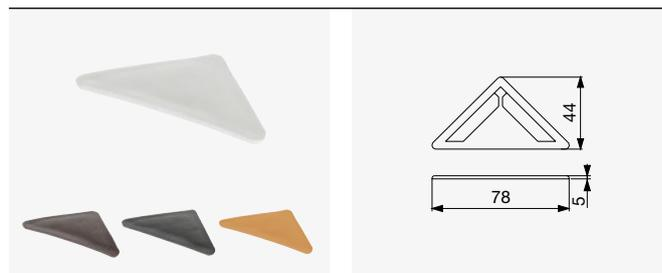

Boja	Kod
Bijela	F002980
Smeđa	F002981
Crna	F002982
Bukva	F002983

### ⊕ Riex GL16 podložak zakucavanjem

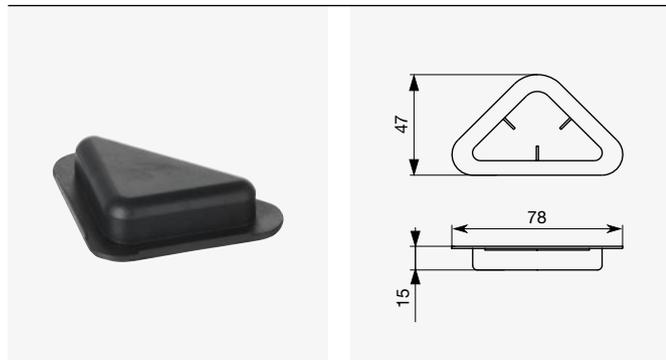

Visina [mm]	Boja	Kod
15	Crna	F002984

### ⊕ Riex GL21 nogica sa vijcima



Visina [mm]	Boja	Kod
20	Crno	F002989
35	Crno	F002991

05

### ⊕ Riex GL24 klizač sa vijcima

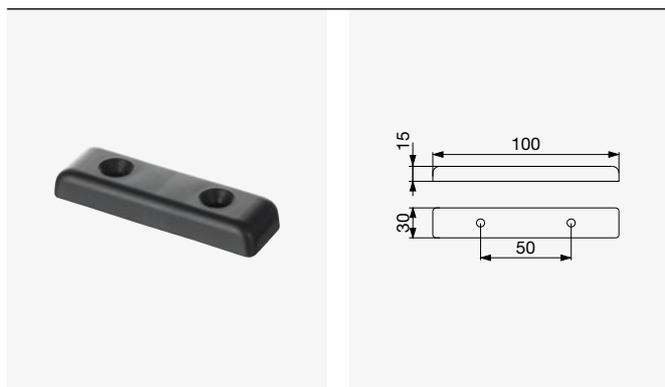

Visina [mm]	Boja	Kod
15	Crna	F002992

### ⊕ Riex GL26 klizač sa tiplom

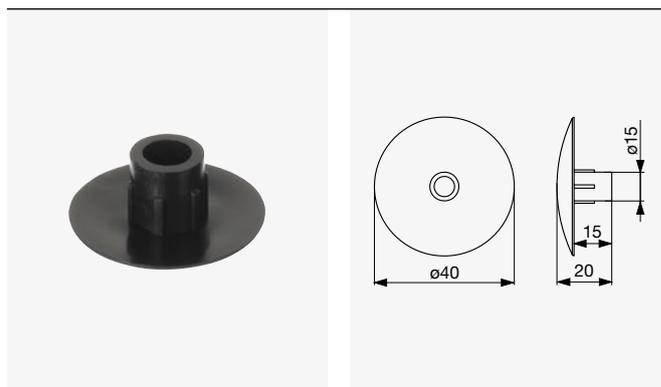

Visina [mm]	Boja	Promjer [mm]	Kod
5	Crna	40	F002993

### ⊕ Riex GL23 klizač sa tiplom



Visina [mm]	Boja	Kod
20	Crna	F002994

### ⊕ Riex GL18 klizač sa tiplom H15



Visina [mm]	Boja	Kod
15	Crna	F002996

### ⊕ Riex GL18 klizač sa tiplom



Visina [mm]	Boja	Kod
35	Crna	F002998



# Noge za namještaj

## ⊕ Riex GS52 noga za nameštaj

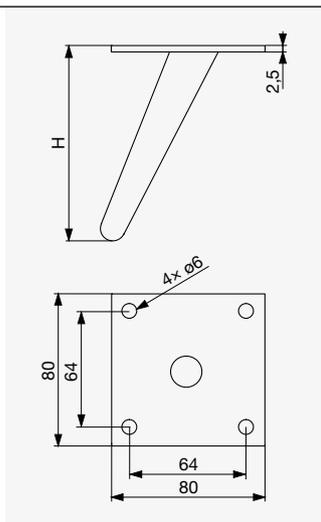

- Debljina ploče 2,5 mm

Visina H [mm]	Crna	Podšavanje visine [mm]
130	F002858	
170	F002859	x
210	F001990	

## ⊕ Riex GS53 noga za nameštaj

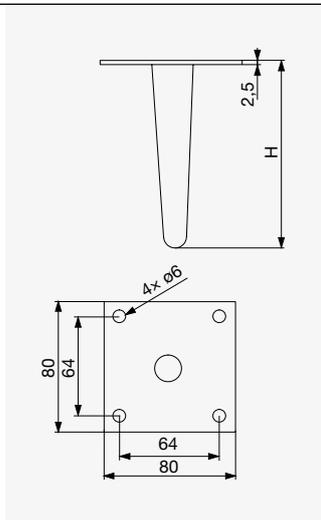

- Debljina ploče 2,5 mm

Visina H [mm]	Crna	Podšavanje visine [mm]
130	F002860	
170	F002861	x

05

### ⊕ Riex GS49 noga za nameštaj

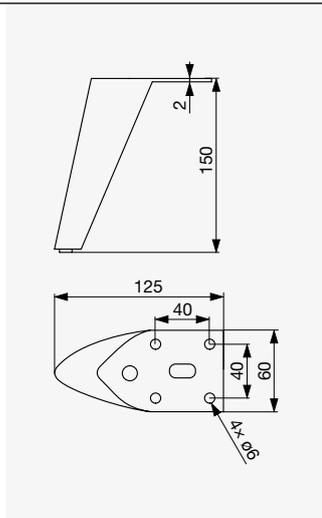

- Debljina ploče 2 mm

Visina H [mm]	Crna	Podlašavanje visine [mm]
150	F003048	x

### ⊕ Riex GS43 noga za nameštaj

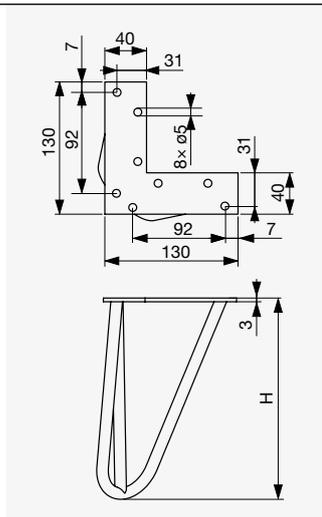

- ∅10 mm zavarena čelična žica
- Ploča od 3 mm

Visina H [mm]	Crna	Podlašavanje visine [mm]
130	F002845	
400	F002846	+2,5
710	F002847	

### ⊕ Riex GS44 noga za nameštaj

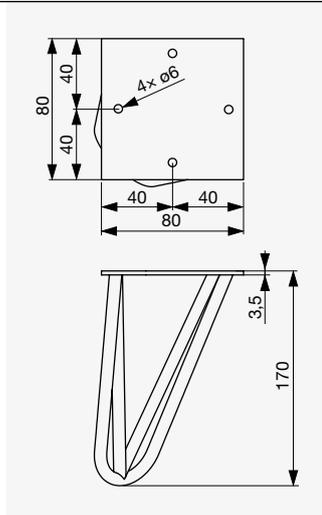

- ∅10 mm zavarena čelična žica
- Ploča od 3 mm

Visina H [mm]	Crna	Podlašavanje visine [mm]
170	F002849	+2,5

### ⊕ Riex GS42 noga za nameštaj

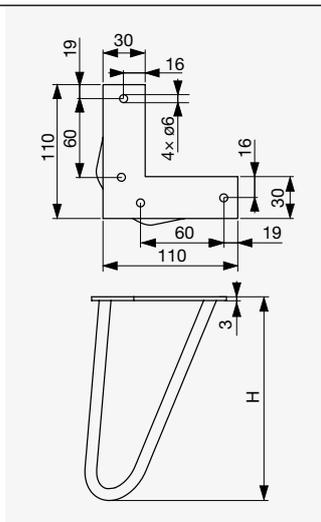

- $\varnothing 10$  mm zavarena čelična žica
- Ploča od 3 mm

Visina H [mm]	Crna	Podšavanje visine [mm]
130	F002850	
400	F002851	x
710	F002852	

### ⊕ Riex GS46 noga za nameštaj

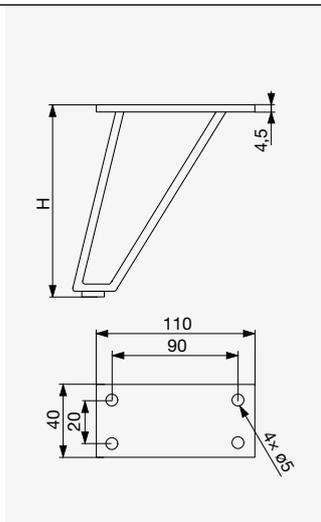

- Profil panela 40 x 4,5 mm

Visina H [mm]	Crna	Podšavanje visine [mm]
130	F002853	
170	F002854	x

### ⊕ Riex GS48 noga za nameštaj

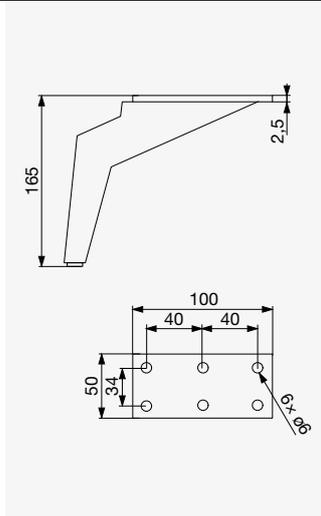

- Debljina profila ploče 2,5 mm

Visina [mm]	Crna	Podšavanje visine [mm]
165	F002857	+2,5

01  
02  
03  
04  
05  
06  
07  
08  
09  
10  
11  
12  
13  
14  
15  
16  
17  
18

05

### ⊕ Riex GS47 noga za nameštaj

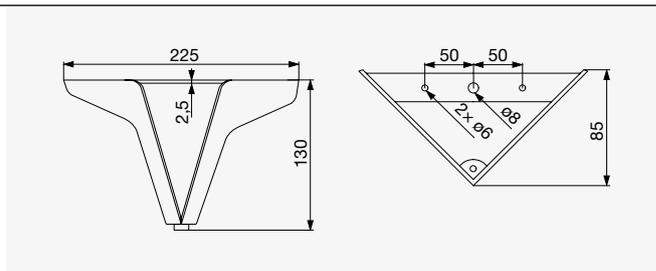

- Debljina lima 2,5 mm

Visina [mm]	Crna	Podешavanje visine [mm]
130	F002862	x

### ⊕ Riex GS36 noga za nameštaj



- Brušeni nikel
- Crni

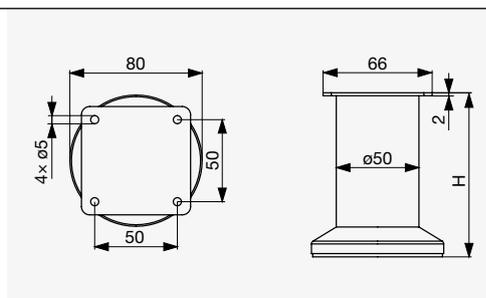

- Debljina stijenke cijevi 1 mm
- Debljina ploče 2 mm

- Krom

Visina H [mm]	Krom	Brušeni nikel	Crna	Podешavanje visine [mm]
80	F001966	F001971	F001976	+7
100	F001967	F001972	F001977	
120	F001968	F001973	F001978	
150	F001969	F001974	F001979	
200	F001970	F001975	F001980	

### ⊕ Riex GS32 noga za nameštaj



- Crno

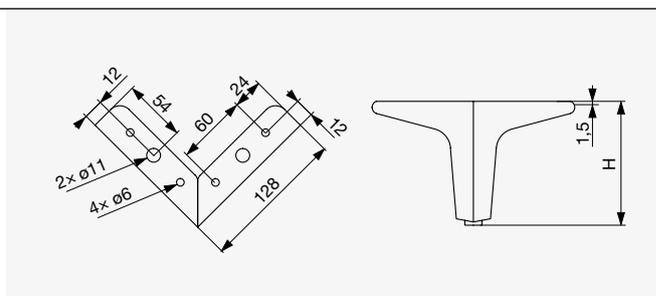

- Debljina lima 1,5 mm

- Krom

Visina H [mm]	Krom	Crna	Podешavanje visine [mm]
130	F001981	F001983	x

## ⊕ Riex GS25 noga za nameštaj



● Mat krom

● Crno

- Debljina materijala cijevi 0,8 mm
- Debljina ploče 2 mm

● Krom

Visina H [mm]	Krom	Mat krom	Crna	Podešavanje visine [mm]
50	F001939	F001940	F001941	+7
80	F001942	F001943	F001944	

## ⊕ Riex GS15 noga za nameštaj

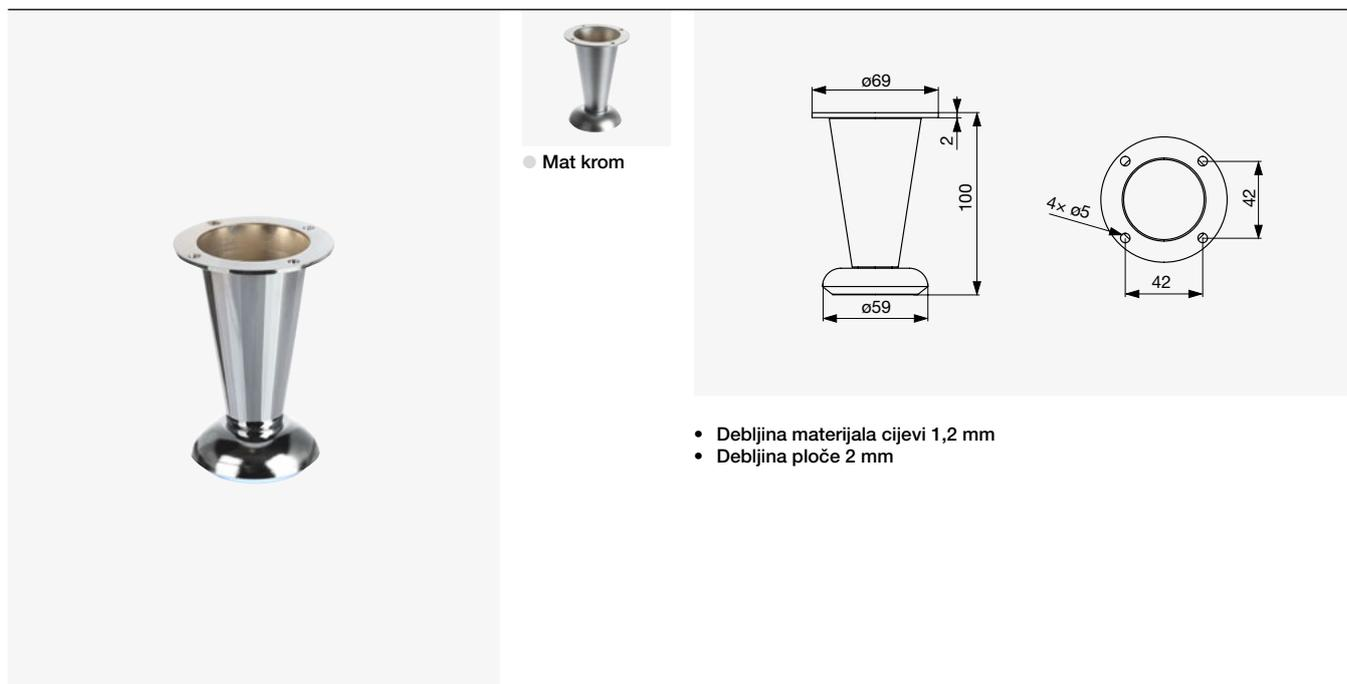

● Mat krom

- Debljina materijala cijevi 1,2 mm
- Debljina ploče 2 mm

● Krom

Visina H [mm]	Krom	Mat krom	Podešavanje visine [mm]
100	F001937	F001938	+7

### ⊕ Riex GS26 noga za namještaj

05

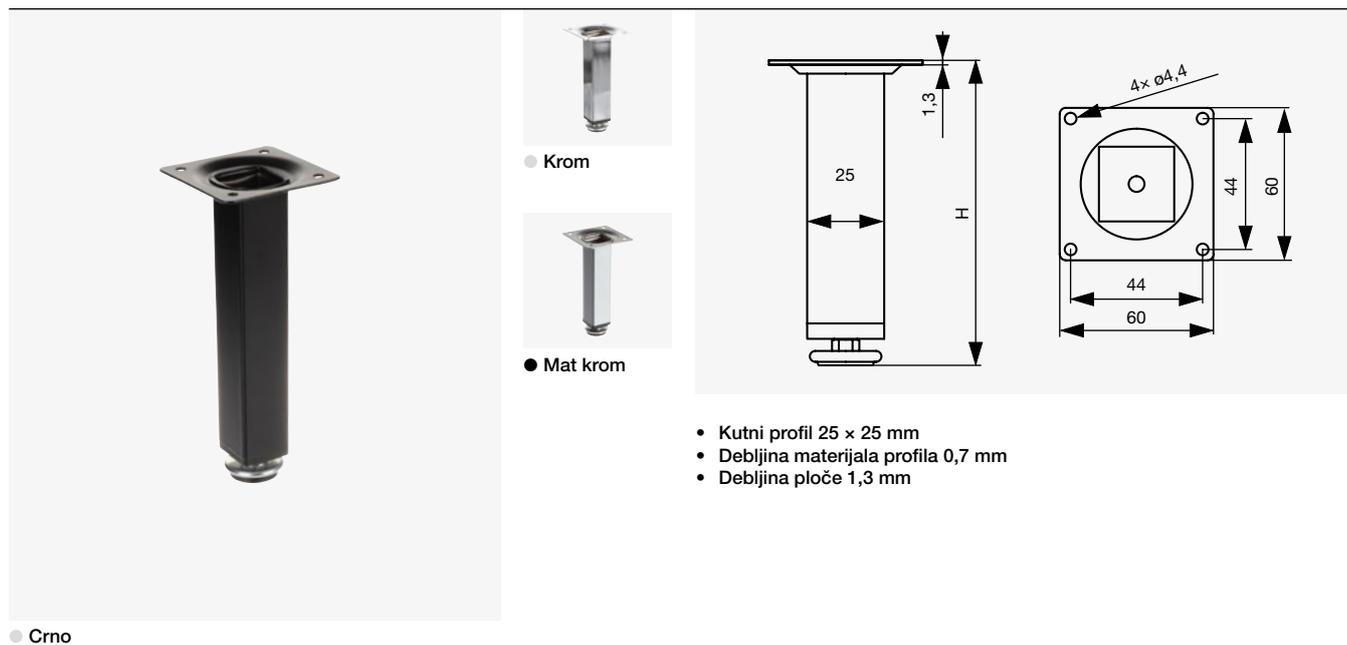

Visina H [mm]	Krom	Mat krom	Crna	Podešavanje visine [mm]
100	F001945	F001946	F003050	+7
120	F001947	F001948	F003051	
150	F001949	F001950	F003052	

### ⊕ Riex GS23 noga za namještaj

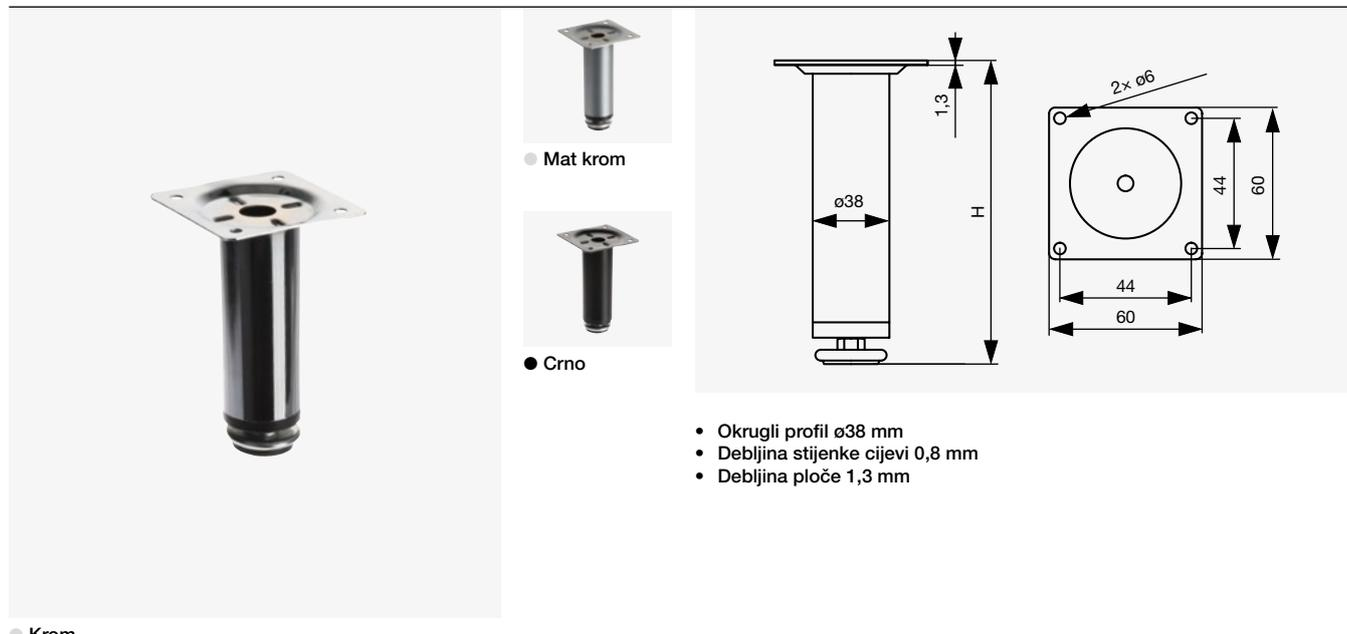

Visina H [mm]	Krom	Mat krom	Crna	Podešavanje visine [mm]
100	F001951	F001952	F003053	+7
120	F001953	F001954	F003054	
150	F001955	F001956	F003055	

### ⊕ Riex GS28 noga za namještaj

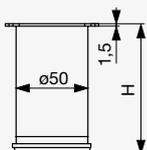
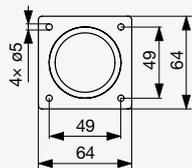

- Okrugli profil  $\varnothing 50$  mm
- Debljina stijenke cijevi 0,6 mm
- Debljina ploče 1,5 mm

Visina H [mm]	Imitacija nehrđajućeg čelika	Podšavanje visine [mm]
100	F001957	
120	F001958	+10
150	F001959	

### ⊕ Riex GS29 noga za namještaj

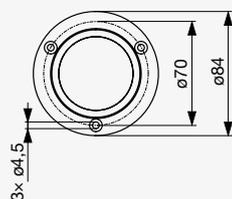
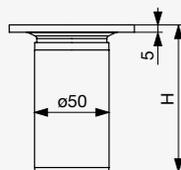

- Okrugli profil  $\varnothing 50$  mm
- Debljina stijenke cijevi 0,6 mm
- Debljina ploče [plastika] 5 mm

Visina H [mm]	Mat krom	Podšavanje visine [mm]
100	F001963	
120	F001964	+25
150	F001965	

### ⊕ Riex GS13 noga za namještaj

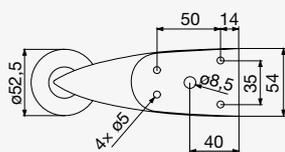
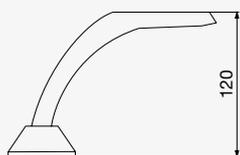

Visina [mm]	Krom	Podšavanje visine [mm]
120	F001895	x

05

### ⊕ Riex GA78 noga za namještaj

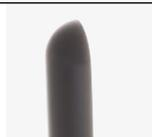

● Mat crna

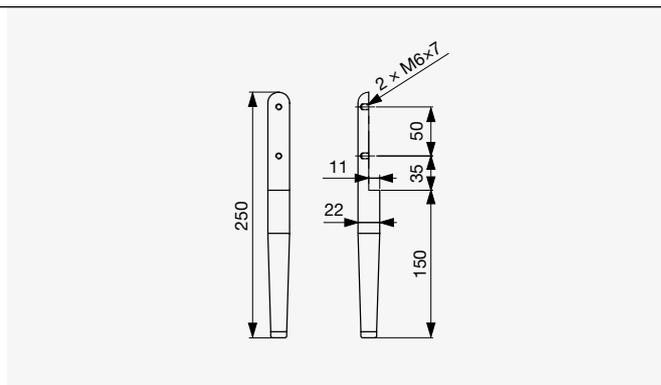

• Čvrsti aluminij

● Polirano zlato

Visina H [mm]	Brušeno zlato	Mat crna	Podešavanje visine [mm]
150	F003059	F003060	+5

### ⊕ Riex GA77 noga za namještaj



● Mat crna

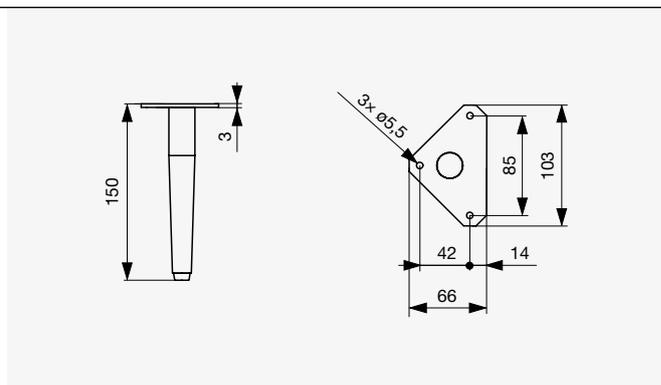

• Čvrsti aluminij  
• Debljina ploče 3 mm

● Polirano zlato

Visina H [mm]	Brušeno zlato	Mat crna	Podešavanje visine [mm]
150	F003057	F003058	+5



## ⊕ Riex GA88 noga za namještaj

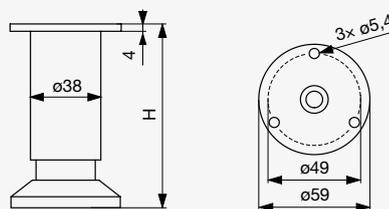

- Okrugli profil  $\varnothing 38$  mm
- Debljina stijenke cijevi 1 mm
- Debljina ploče 4 mm

Visina H [mm]	Brušeni niki	Podešavanje visine [mm]
80	F001902	
100	F001903	
120	F001904	+15
150	F001905	

## ⊕ Riex GA68 noga za nameštaj



● Mat crna boja

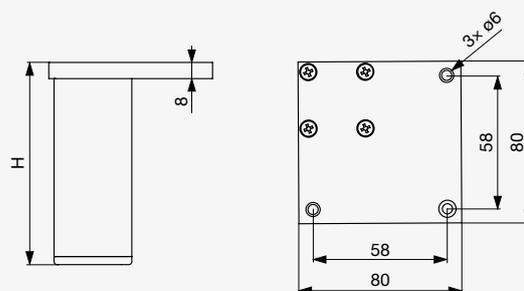

- Kutni profil  $38 \times 38$  mm
- Debljina materijala profila 1 mm
- Debljina ploče 8 mm

● Eloksirani aluminij

Visina H [mm]	Eloksirani aluminij	Mat crna	Podešavanje visine [mm]
80	F001909	F001910	
100	F001911	F001912	
120	F001913	F001914	
150	F001915	F001916	*
200	F001917	F001918	

05 **⊕ Riex GA60 noga za namještaj**

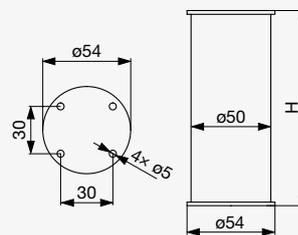

- Okrugli profil  $\varnothing 50$  mm
- Debljina stijenke cijevi 0,8 mm

Visina H [mm]	Eloksirani aluminij	Podešavanje visine [mm]
100	F001896	
120	F001897	+7
150	F001898	

**⊕ Riex GA63 noga za nameštaj**

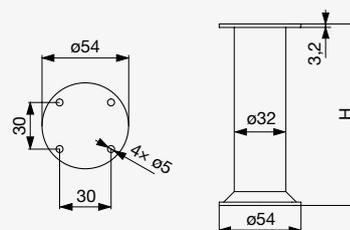

- Okrugli profil  $\varnothing 32$  mm
- Debljina stijenke cijevi 0,8 mm

Visina H [mm]	Eloksirani aluminij	Podešavanje visine [mm]
100	F001899	
120	F001900	+15
150	F001901	

## ⊕ Riex GA34 noga za namještaj $\varnothing 40$ mm

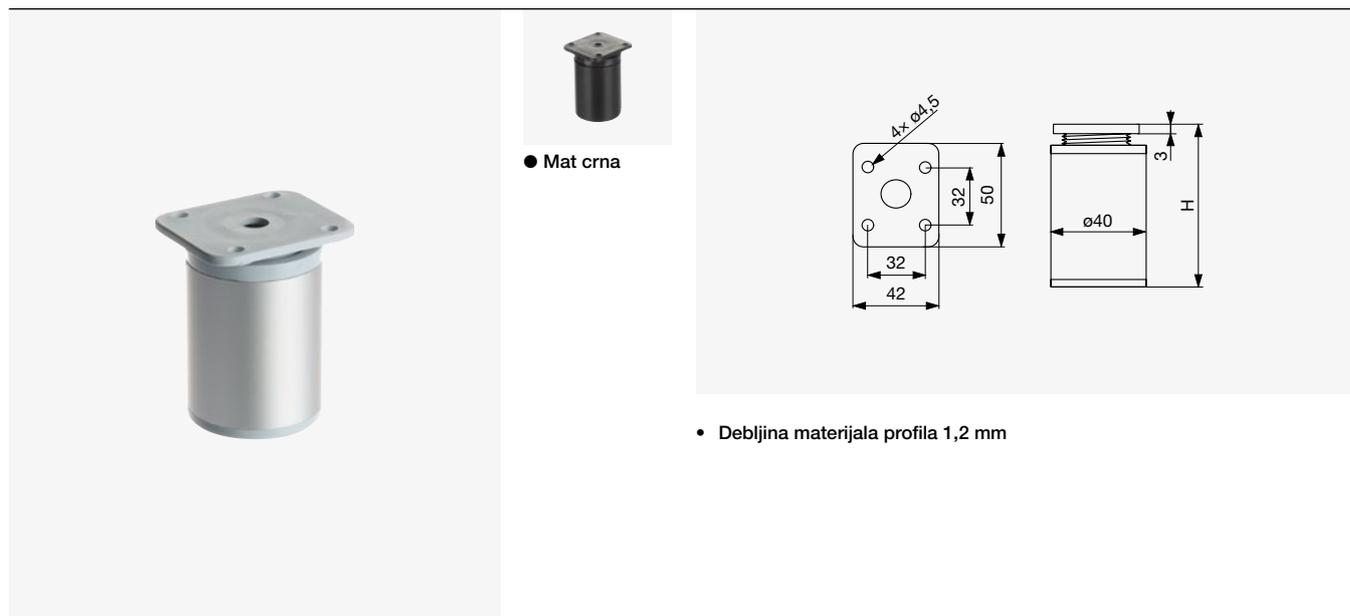

● Mat crna

• Debljina materijala profila 1,2 mm

● Elokisirani aluminij

Visina H [mm]	Elokisirani aluminij	Mat crna	Podešavanje visine [mm]
60	F002872	F002874	
100	F002873	F002875	+15
150	F003027	F003028	

## ⊕ Riex GA33 noga za namještaj $\varnothing 60$ mm

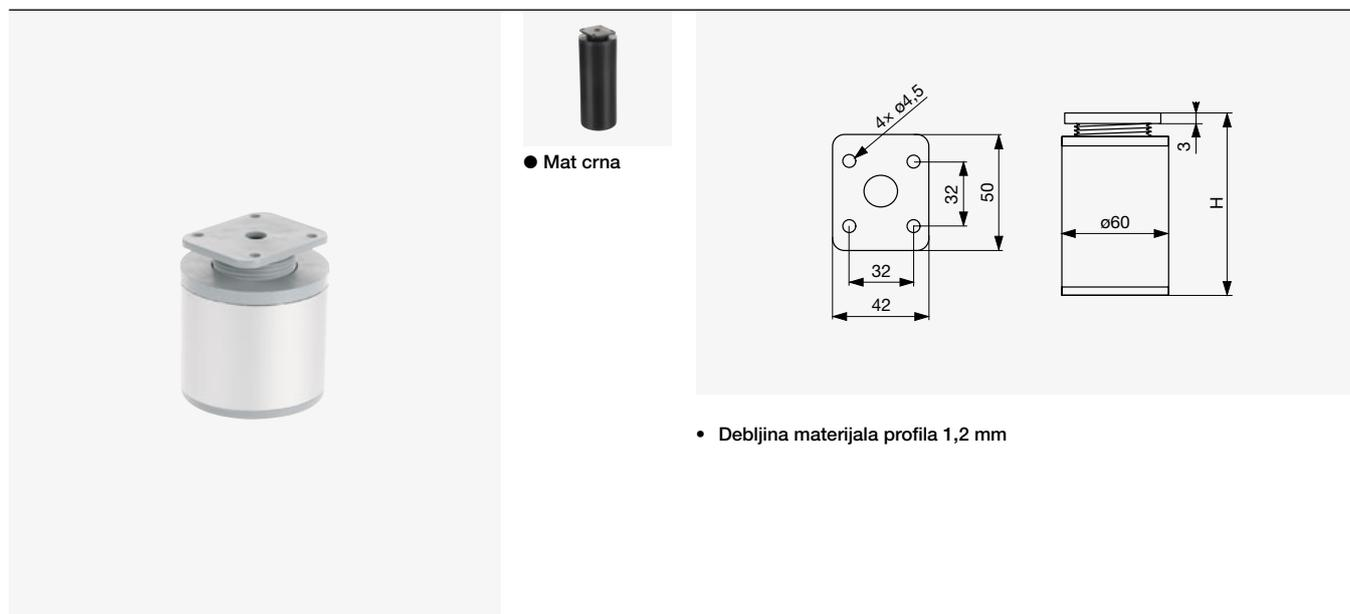

● Mat crna

• Debljina materijala profila 1,2 mm

● Elokisirani aluminij

Visina H [mm]	Elokisirani aluminij	Mat crna	Podešavanje visine [mm]
60	F002876	F002878	
100	F002877	F002879	+15
150	F003029	F003030	

### ⊕ Riex GA35 noga za namještaj 40 × 40 mm

05

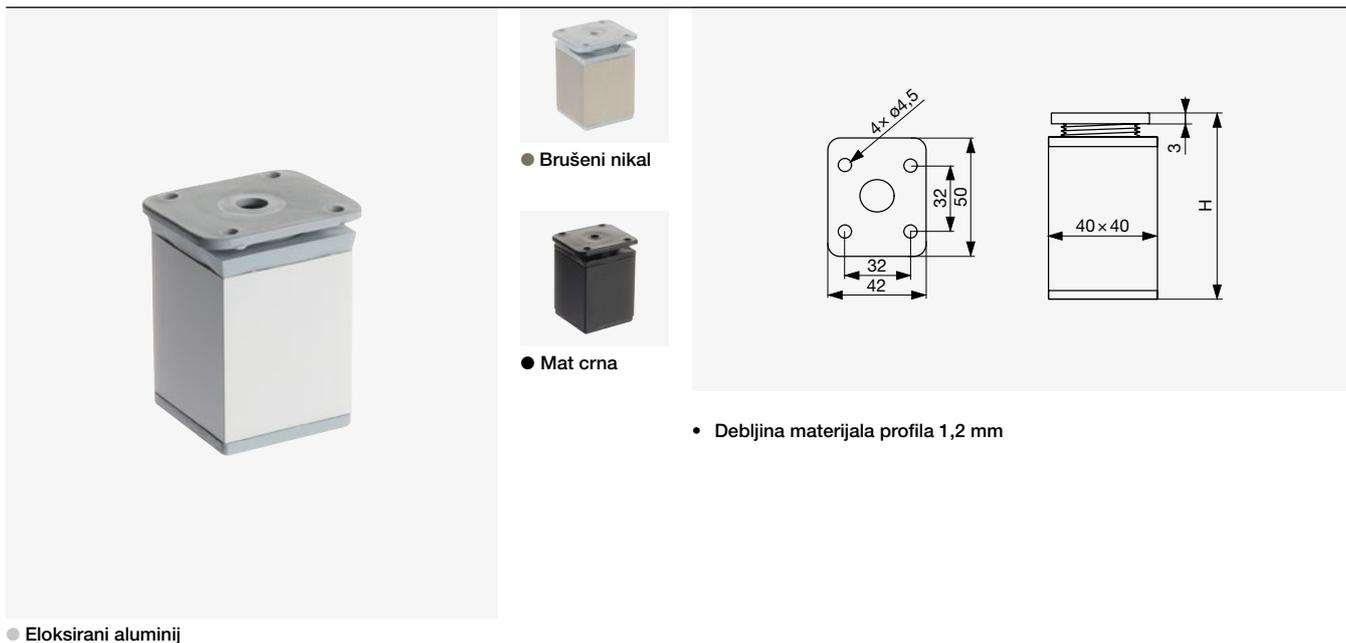

● Elokirani aluminij

• Debljina materijala profila 1,2 mm

Visina H [mm]	Elokirani aluminij	Brušeni nikel	Mat crna	Podšavanje visine [mm]
60	F002880	F002883	F002885	
100	F002881	F002884	F002886	+15
150	F002882	F003023	F003024	

### ⊕ Riex GA36 noga za namještaj 60 × 60 mm

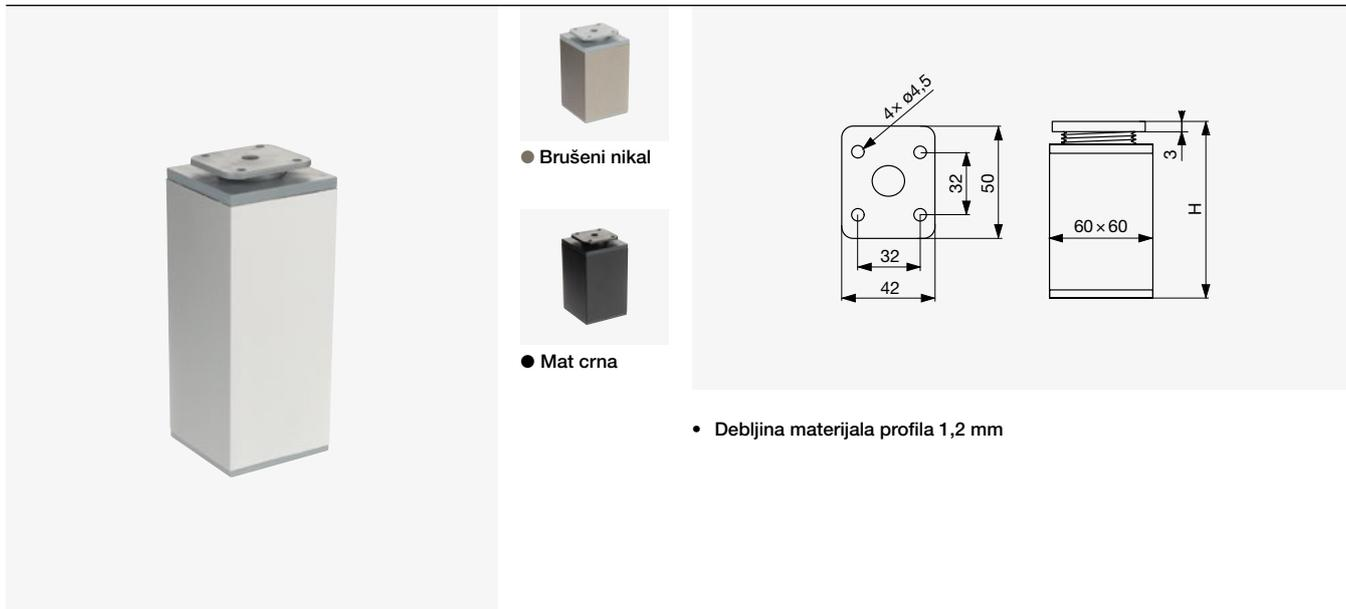

● Elokirani aluminij

• Debljina materijala profila 1,2 mm

Visina H [mm]	Elokirani aluminij	Brušeni nikel	Mat crna	Podšavanje visine [mm]
60	F002887	F002889	F002891	
100	F002888	F002890	F002892	+15
150	F003025	F003026	×	

## ⊕ Riex GA38 noga za namještaj 80 × 80 mm

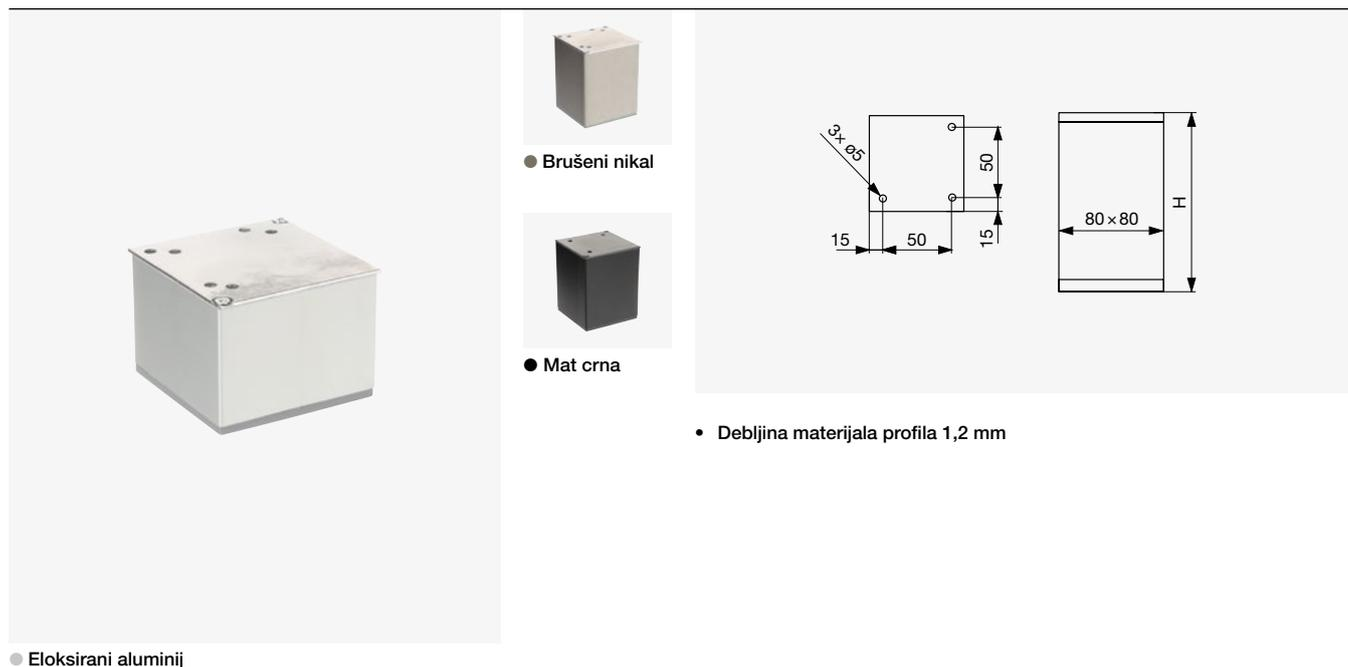

Visina H [mm]	Eloksirani aluminij	Brušeni nikel	Mat crna
60	F002893	F002895	F002897
100	F002894	F002896	F002898

# Plastične noge za namještaj

05

- Jednostavne i stabilne noge
- Različite visine i oblici

## ➤ Riex GR70 noga za nameštaj

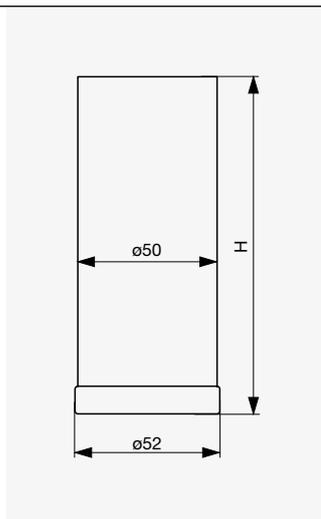

- 3 različite visine
- Nosivost 500 kg

Visina H [mm]	Srebro	Podlašavanje visine [mm]
100	F003589	
150	F003590	+10
200	F003591	

## ➤ Riex GR70 spojna pločica

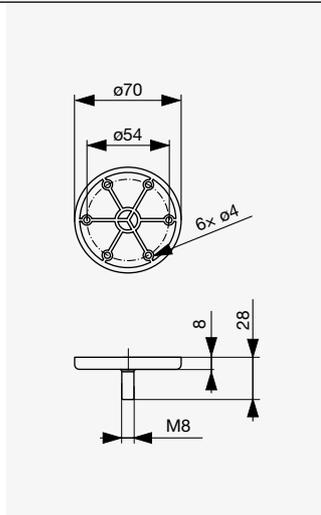

- Tipa GR70

Boja	Kod
Siva	F003592

## ⊕ Riex GR77 noga za namještaj

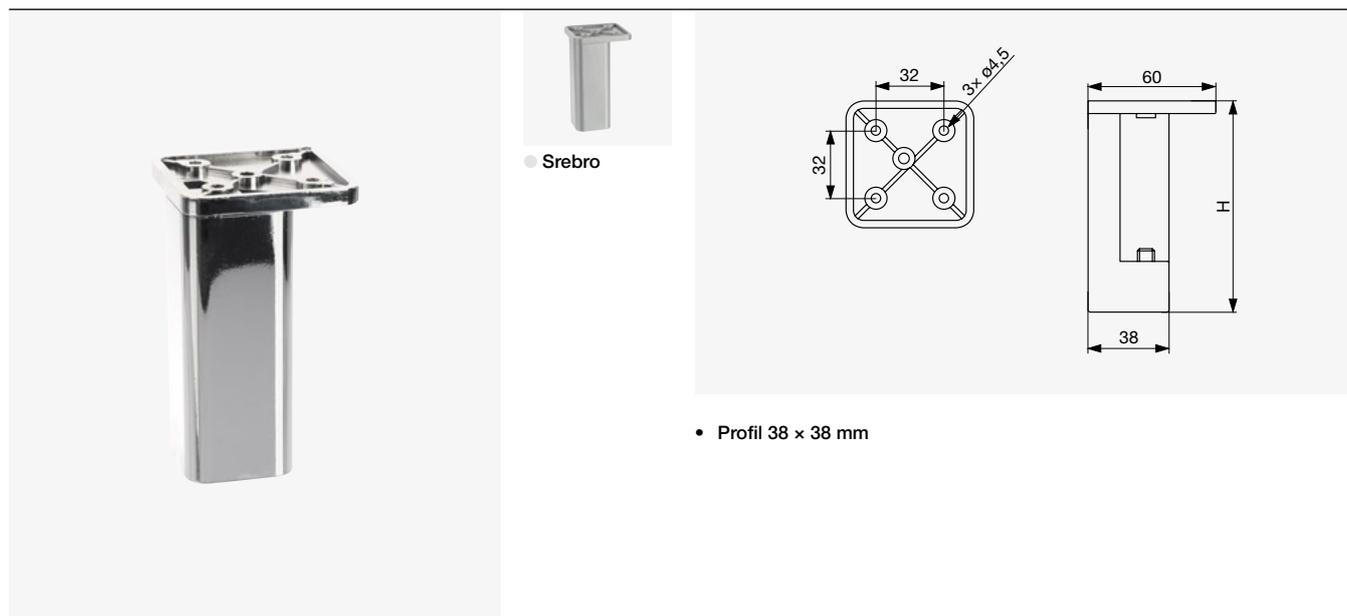

● Srebro

• Profil 38 x 38 mm

● Krom

Visina H [mm]	Krom	Srebro	Podešavanje visine [mm]
100	F003596	F003599	
150	F003597	F003600	+10
180	F003598	F003601	

## ⊕ Riex GR76 noga za namještaj

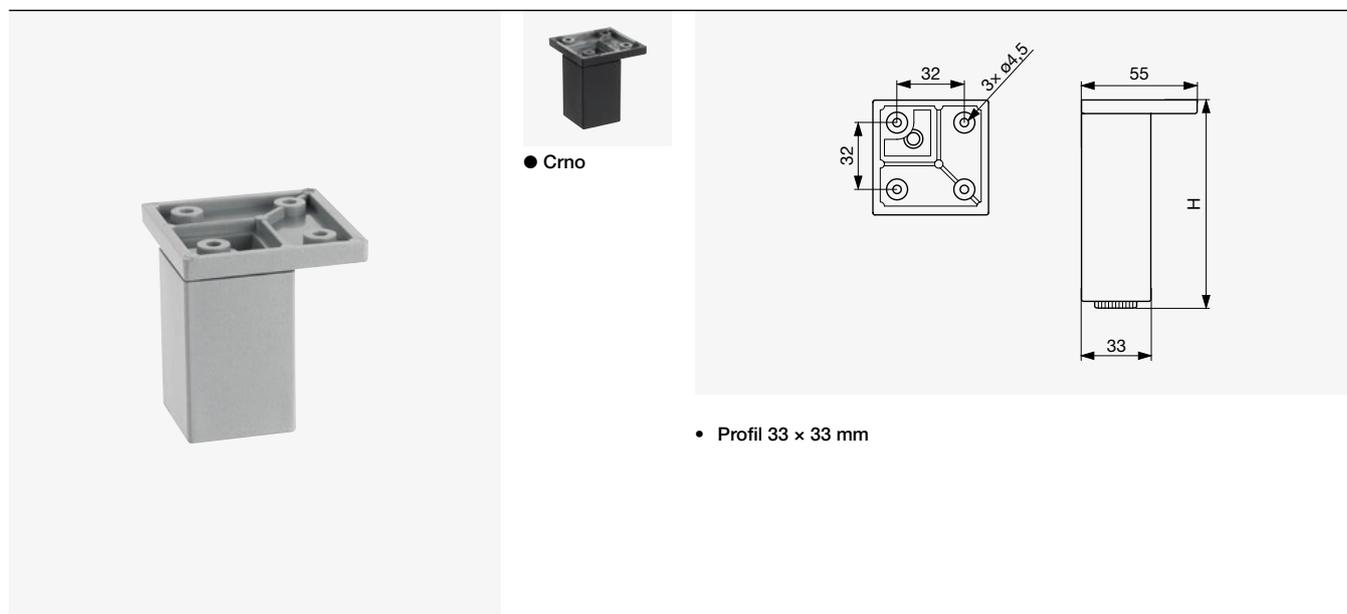

● Crno

• Profil 33 x 33 mm

● Srebro

Visina H [mm]	Srebro	Crna	Podešavanje visine [mm]
60	F003609	F003612	
100	F003607	F003610	+10
150	F003608	F003611	

05

### ⊕ Riex GR79 noga za namještaj



● Crno

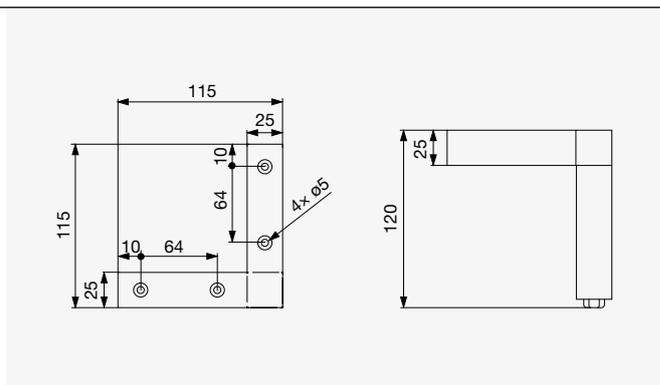

• Profil 25 x 25 mm

● Srebro

Visina H [mm]	Srebro	Crna	Podšavanje visine [mm]
120	F004310	F004311	+7

### ⊕ Riex GR75 noga za namještaj



● Crno

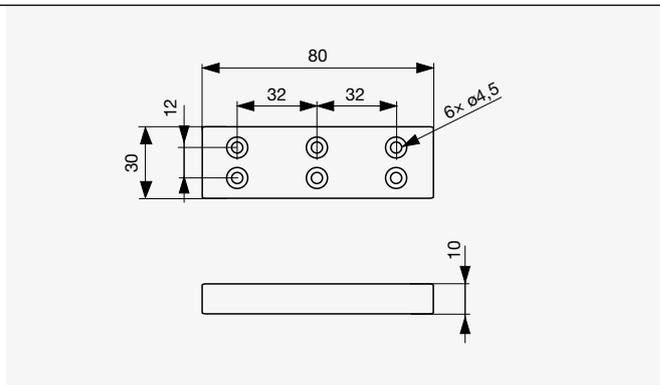

• Veličina 80 x 30 x 10 mm

● Srebro

Visina H [mm]	Srebro	Crna
10	F003605	F003606



## ⊕ Riex GR72 noga za namještaj



● Srebro



● Krom

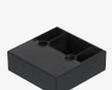

● Crno

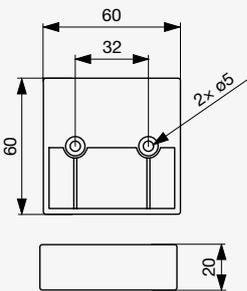

• Veličina 60 × 60 × 20 mm

Visina H [mm]	Krom	Srebro	Crna
20	F003595	F003593	F003594

## ⊕ Riex GR73 noga za namještaj



● Srebro

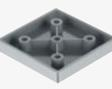

● Krom



● Crno

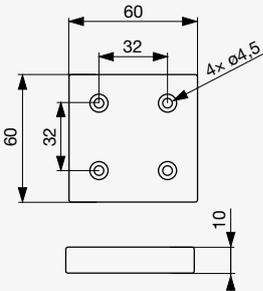

• Veličina 60 × 60 × 10 mm

Visina H [mm]	Krom	Srebro	Crna
10	F003603	F003602	F003604

05

**⊕ Riex GP20 noga za namještaj**

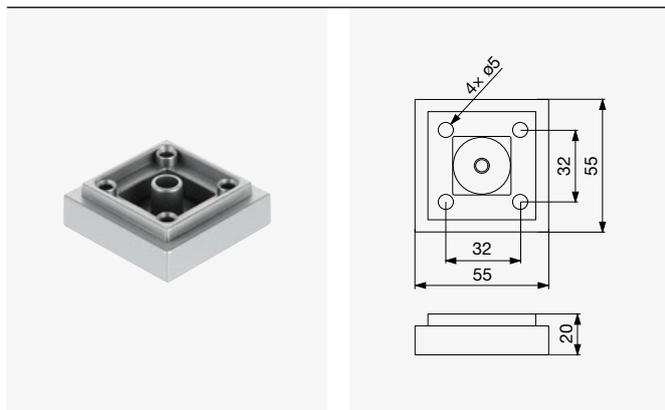

Boja	Visina [mm]	Mjera [mm]	Kod
Srebro	20	55 × 55	F003624

**⊕ Riex GP10 noga za namještaj**

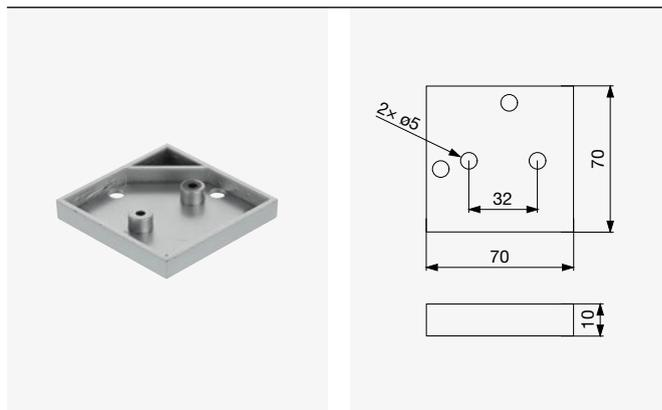

Boja	Visina [mm]	Mjera [mm]	Kod
Srebro	10	70 × 70	F003625

**⊕ Riex GP21 noga za namještaj**

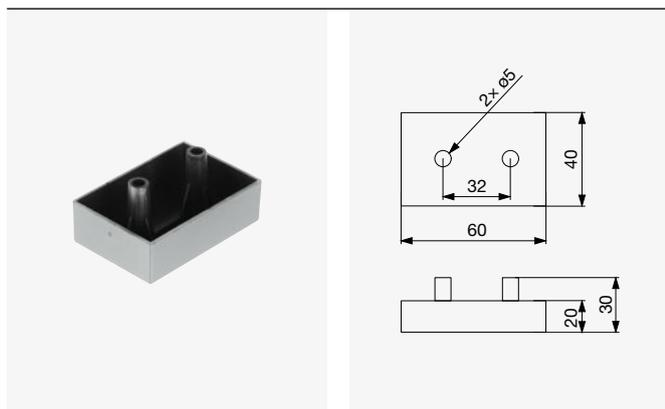

Boja	Visina [mm]	Mjera [mm]	Kod
Srebro	20	60 × 40	F003626

**⊕ Riex GP22 noga za namještaj**

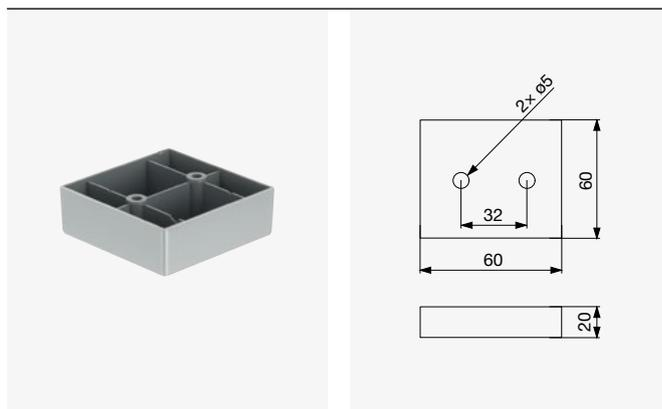

Boja	Visina [mm]	Mjera [mm]	Kod
Srebro	20	60 × 60	F003627

**⊕ Riex GP23 noga za namještaj**

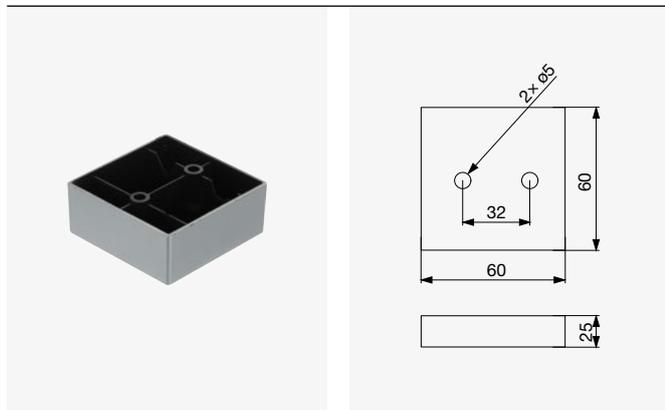

Boja	Visina [mm]	Mjera [mm]	Kod
Srebro	25	60 × 60	F003628

**⊕ Riex GP25 noga za namještaj**

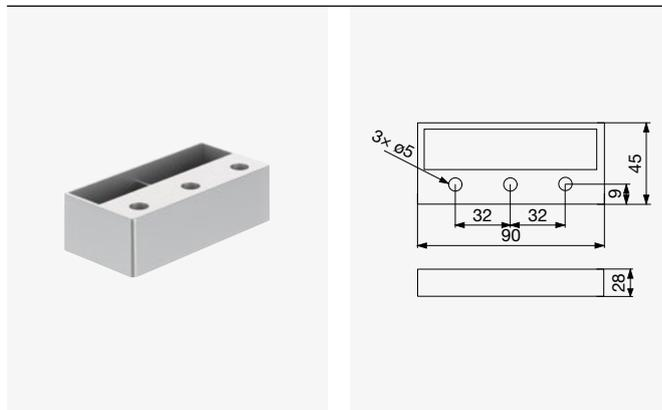

Boja	Visina [mm]	Mjera [mm]	Kod
Srebro	28	90 × 45	F003629

### ⊕ Riex GP24 noga za namještaj

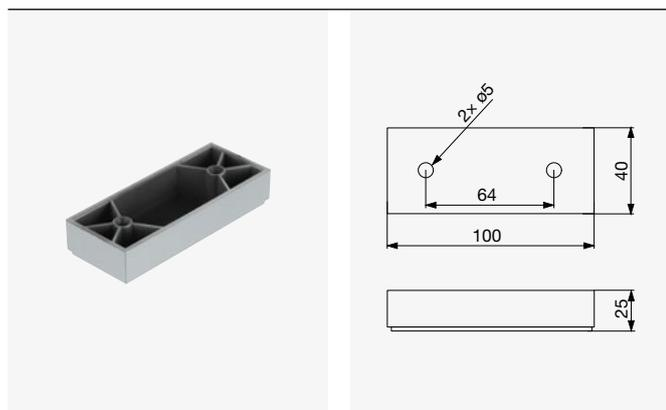

Boja	Visina [mm]	Mjera [mm]	Kod
Srebro	25	100 × 40	F003630

### ⊕ Riex GP15 noga za namještaj

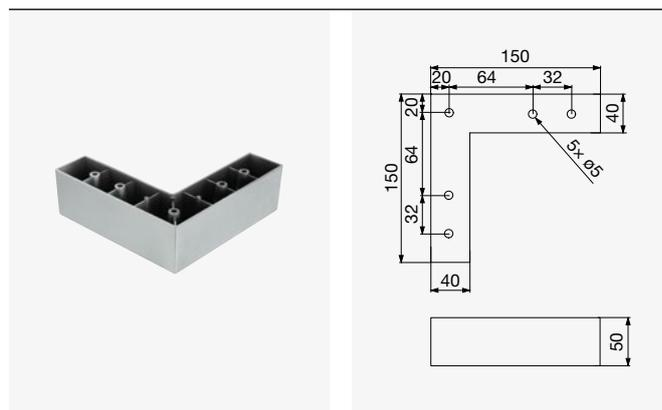

Boja	Visina [mm]	Mjera [mm]	Kod
Srebro	50	150 × 150	F003631

### ⊕ Riex GP13 noga za namještaj

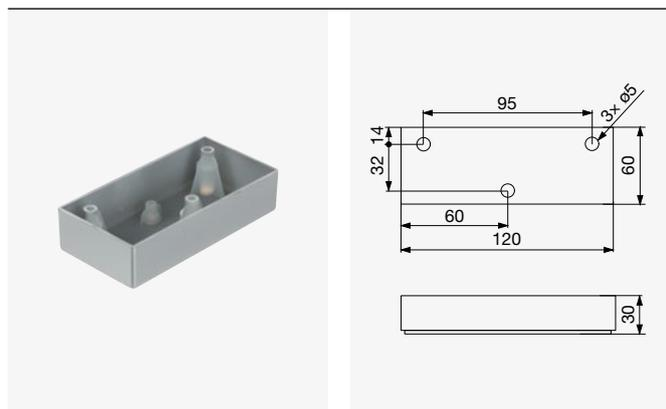

Boja	Visina [mm]	Mjera [mm]	Kod
Srebro	30	120 × 60	F003632

### ⊕ Riex GP11 noga za namještaj

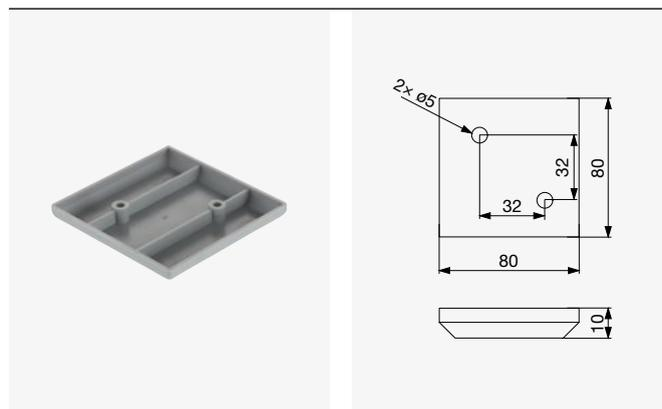

Boja	Visina [mm]	Mjera [mm]	Kod
Srebro	10	80 × 80	F003633

### ⊕ Riex GP19 noga za namještaj

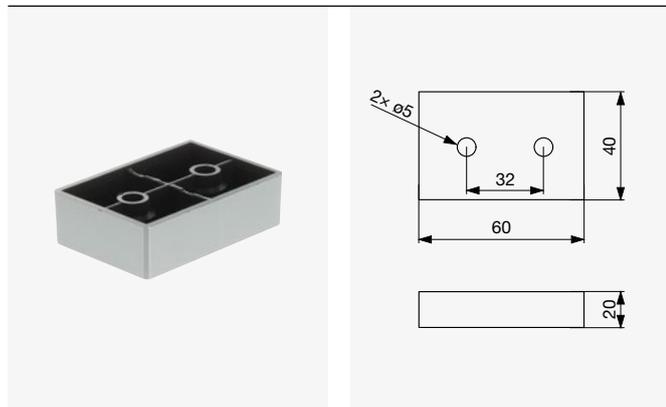

Boja	Visina [mm]	Mjera [mm]	Kod
Srebro	20	60 × 40	F004309

01  
02  
03  
04  
05  
06  
07  
08  
09  
10  
11  
12  
13  
14  
15  
16  
17  
18

# Drvene noge za namještaj

05



## ● Riex GW20 drvena noga za namještaj

● Nelakiran prirodni hrast

● Lakirani prirodni hrast

● Nelakirana prirodna bukva

● Nepremazan prirodni bor

Preporučena kombinacija s drvenim ručkama str. 4.69.

- Stožasti stan
- S pločicom, vijkom i toboganom od filca
- Pakirano po 4 komada
- Prirodno drvo
- Lakirano / nelakirano

● Nelakiran prirodni hrast

Visina H [mm]	Nelakiran prirodni hrast	Lakiran prirodni hrast	Nelakirana prirodna bukva	Nelakirani prirodni bor	Podšavanje visine [mm]
100	F004992	F004995	F004991	F004990	×
150	F004998	F005001	F004997	F004996	

## ⊕ Riex GW22 drvena noga za namještaj





● Nelakirani prirodni hrast



● Lakirani prirodni hrast

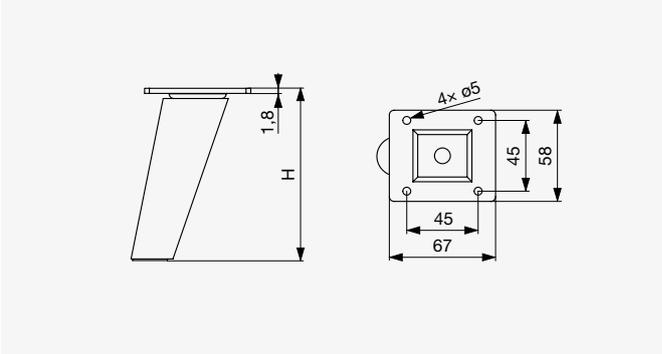

● Nelakirani prirodni bor



Preporučena kombinacija s drvenim ručkama str. 4.69.

- Stožasti nagib
- S pločicom, vijkom i toboganom od filca
- Pakirano po 4 komada
- Prirodno drvo
- Lakirano / nelakirano

● Nelakirana prirodna bukva

Visina H [mm]	Nelakiran prirodni hrast	Lakiran prirodni hrast	Nelakirana prirodna bukva	Nelakirani prirodni bor	Podešavanje visine [mm]
100	F005004	F005007	F005003	F005002	x
150	F005010	F005013	F005009	F005008	

## ⊕ Riex GW25 drvena noga za namještaj



● Nelakirani prirodni hrast



● Nelakirani prirodni bor

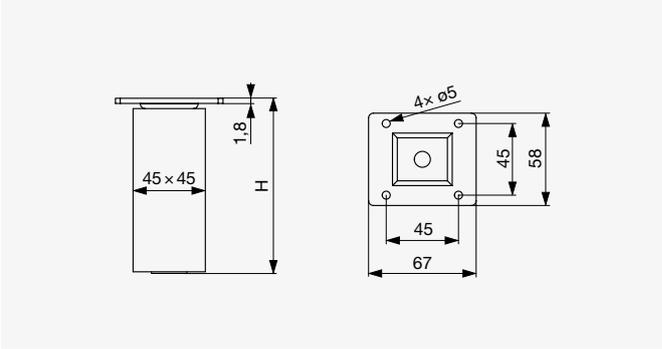

Preporučena kombinacija s drvenim ručkama str. 4.69.

- Kvadrat
- S pločicom, vijkom i toboganom od filca
- Pakirano po 4 komada
- Prirodno drvo
- Nije lakiran

● Nelakirana prirodna bukva

Visina H [mm]	Nelakiran prirodni hrast	Nelakirana prirodna bukva	Nelakirani prirodni bor	Podešavanje visine [mm]
100	F005016	F005015	F005014	x
150	F005022	F005021	F005020	

# Kotačići za namještaj

05

- Za razne primjene
- Elegantly dizajnirani modeli kotačića, rješenja visokih performansi, kotačići za tehnička rješenja itd.
- Nosivost kotačića za namještaj navedenih u katalogu rezultat je statičkih mjerenja.



## ● Riex GC10 kotačići za namještaj

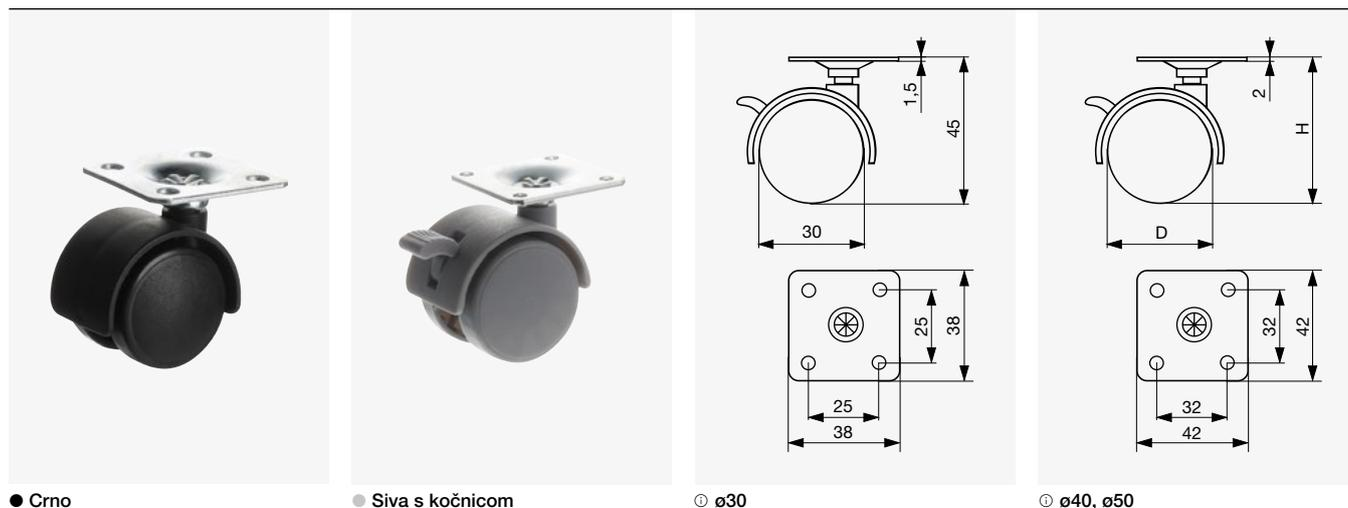

øD [mm]	Boja	Kočnice	Kod	Nosivost [kg]	Visina H [mm]	Širina kotača [mm]	Ploča [mm]
30	Crno	Ne	F000838	25	45	32	38 × 38 × 1,5
		Da	F000841				
40	Crno	Ne	F000839	30	55	38	42 × 42 × 2
		Da	F000842				
	Sivo	Ne	F002325				
		Da	F002327				
50	Crno	Ne	F000840	40	65	45	42 × 42 × 2
		Da	F000843				
	Sivo	Ne	F002326				
		Da	F002328				

## ● Riex GT05 kotačići za namještaj **ECONOMY**



øD [mm]	Boja	Kočnice	Kod	Nosivost [kg]	Visina H [mm]	Širina kotača [mm]	Ploča [mm]
40	Crno	Ne	F000848	20	54	37	38 × 38 × 1,5
		Da	F000850				
50	Crno	Ne	F000849	30	63	44	38 × 38 × 1,5
		Da	F000851				

## ● Riex GC12 kotačići za namještaj

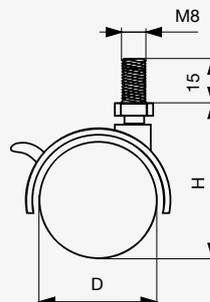

● Crno

● Crno s kočnicom

øD [mm]	Boja	Kočnice	Kod	Nosivost [kg]	Vijak [mm]	Visina H [mm]	Širina kotača [mm]
40	Crna	No	F000844	30	M8 × 15	50	38
		Da	F000846				
50	Crna	No	F000845	40	M8 × 15	60	45
		Da	F000847				

## ● Riex GF30 kotačići za namještaj s mekim gazistem

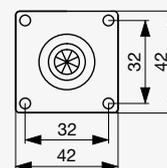
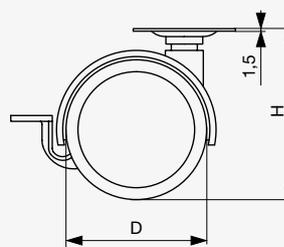

● Crno

● Crno s kočnicom

øD [mm]	Boja	Kočnice	Kod	Nosivost [kg]	Visina H [mm]	Širina kotača [mm]	Ploča [mm]
40	Crna	Ne	F000852	20	56	39	42 × 42 × 1,5
		Da	F000854				
50	Crna	Ne	F000853	40	69	54	
		Da	F000855				



## ● Riex GC70 kotačići za namještaj s mekim klizačem

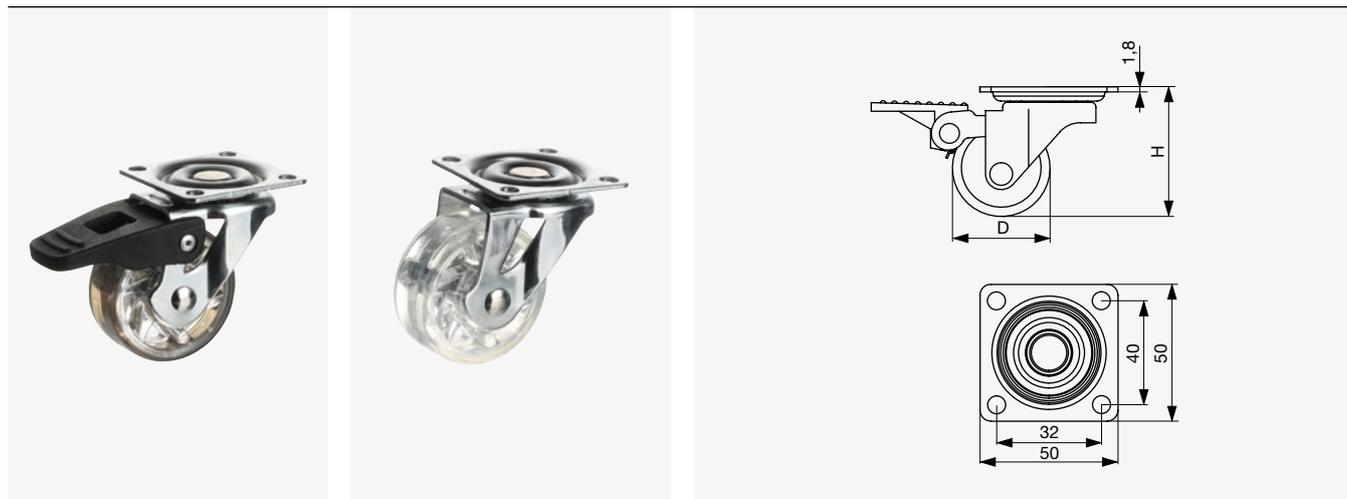

● Prozirno smeđa s kočnicom

○ Prozirno bijela

øD [mm]	Boja	Kočnice	Kod	Nosivost [kg]	Visina H [mm]	Širina gazišta [mm]	Ploča [mm]
35	Prozirno smeđa	Ne	F000881	25	52	20	
		Da	F000880				
	Prozirno bijela	Ne	F000871				
		Da	F000870				
50	Prozirno smeđa	Ne	F000887	35	65	20	50 × 50
		Da	F000886				
	Prozirno bijela	Ne	F000877				
		Da	F000876				
75	Prozirno smeđa	Ne	F000889	45	90	24	
		Da	F000888				
	Prozirno bijela	Ne	F000879				
		Da	F000878				

## ● Riex GB88 kotačići za namještaj s mekim vodilicama

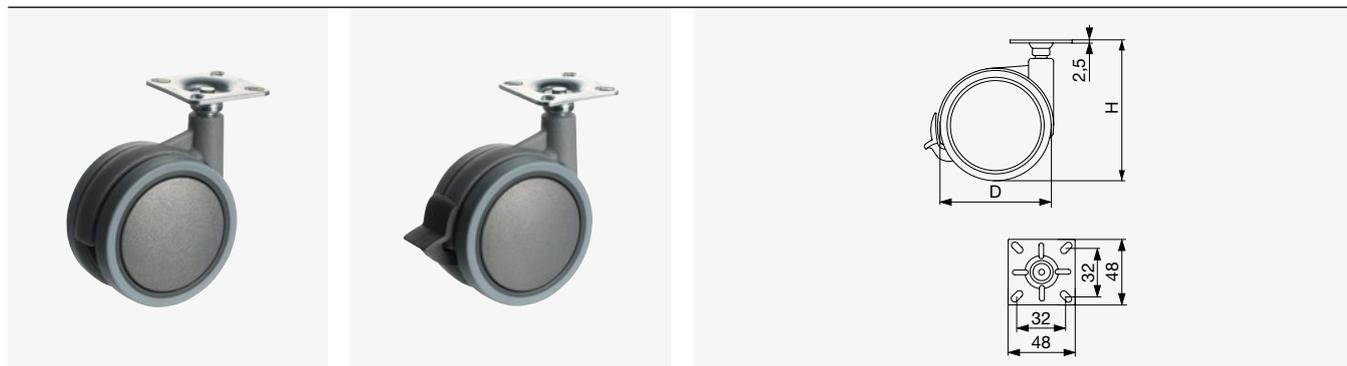

● Tamno siva

● Tamno siva s kočnicom

øD [mm]	Boja	Kočnice	Kod	Nosivost [kg]	Visina H [mm]	Širina kotača [mm]	Ploča [mm]
60	Tamno siva	Ne	F000864	50	87	42	48 × 48 × 2,5
		Da	F000867				
75	Tamno siva	Ne	F000865	60	105	48	
		Da	F000868				

## ● Tente Stylea kotačići za namještaj s mekom vodilicom

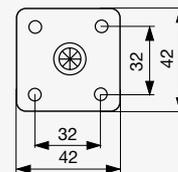
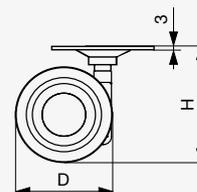

● Crno

● Crno s kočnicom

øD [mm]	Boja	Kočnice	Kod	Nosivost [kg]	Visina H [mm]	Širina kotača [mm]	Ploča [mm]
40	Crna	Ne	F003579	80	44	52	42 × 42 × 3
		Da	F003580				
65	Crna	Ne	F003497	100	78	46	
		Da	F003498				
75	Crna	Ne	F003499		87	53	
		Da	F003500				

## ● Tende Lumina kotačići za namještaj

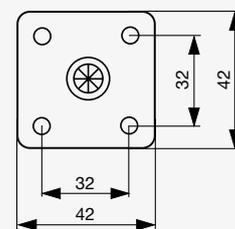
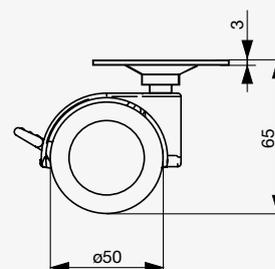

● Crno

● Crno s kočnicom

Promjer [mm]	Boja	Kočnice	Kod	Nosivost [kg]	Visina [mm]	Širina kotača [mm]	Ploča [mm]
50	Crna	Ne	F003501	80	65	55	42 × 42 × 3
		Da	F003502				

## ● Tente Lumina kotačići za namještaj s mekom vodilicom



● Crno

● Crno s kočnicom

Promjer [mm]	Boja	Kočnice	Kod	Nosivost [kg]	Visina [mm]	Širina kotača [mm]	Ploča [mm]
50	Black	No	F003503	80	65	55	42 × 42 × 3
		Da	F003504				

## ● Tente Linea lagani kotačići za namještaj s mekom vodilicom



● Siva

● Svijetlo siva

øD [mm]	Boja	Kočnice	Kod	Nosivost [kg]	Visina [mm]	Širina kotača [mm]	Ploča [mm]
50	Siva	Ne	F003505	100	61	48	42 × 42 × 3
		Da	F003506				
	Svijetlo siva	Ne	F003507				
		Da	F003508				

## ● Tente Linea kotačić za namještaj s mekim gazištem

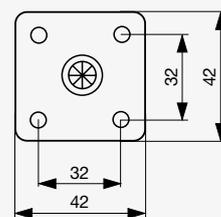
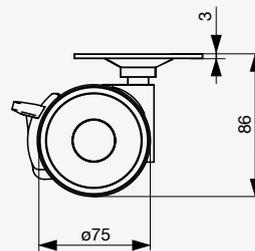

● Svijetlo siva

● Svijetlo siva s kočnicom

Promjer [mm]	Boja	Kočnice	Kod	Nosivost [kg]	Visina [mm]	Širina kotača [mm]	Ploča [mm]
75	Svijetlo siva	Ne	F003509	180	86	55	42 x 42 x 3
		Da	F003510				

## ● Tente Levina kotačić za namještaj s mekom vodilicom

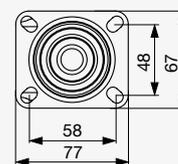
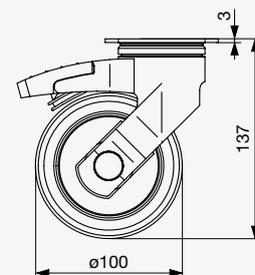
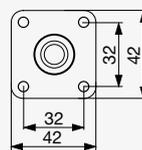
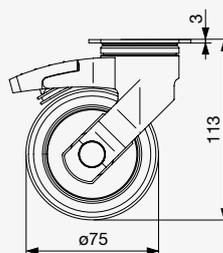

● ø75 Siva

● ø100 Siva s kočnicom

Ⓢ F003512

Ⓢ F003514

Promjer [mm]	Boja	Kočnice	Kod	Nosivost [kg]	Visina [mm]	Širina kotača [mm]	Ploča [mm]
75	Siva	No	F003511	150	113	25	42 x 42 x 3
		Da	F003512				
100	Siva	No	F003513	200	137	32	77 x 67 x 3
		Da	F003514				

### ⊕ Riex GC42 kotačić za namještaj s mekim gazištem

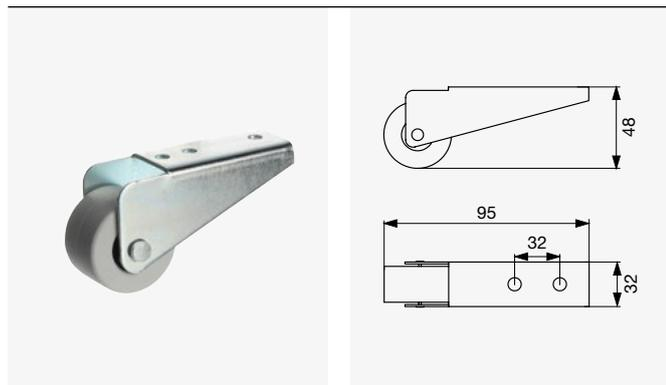

Promjer [mm]	Boja	Izgradnja	Kod	Nosivost [kg]	Visina [mm]	Širina kotača [mm]
40	Sivo	Odlučan	F002999	100	48	32

### ⊕ Riex GC44 kotačić za namještaj s mekim gazištem

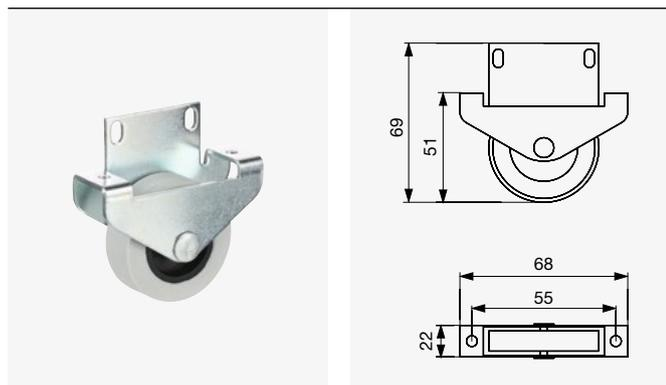

Promjer [mm]	Boja	Izgradnja	Kod	Nosivost [kg]	Visina [mm]	Širina kotača [mm]
45	Siva	Fiksna	F003000	90	51	22

### ⊕ Riex GC46 kotačić za namještaj s mekim klizačem

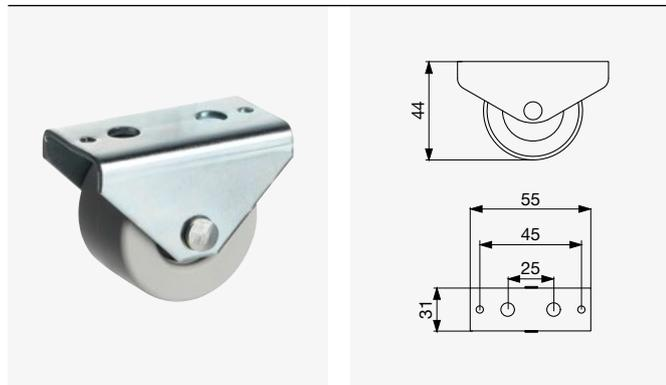

Promjer [mm]	Boja	Izgradnja	Kod	Nosivost [kg]	Visina [mm]	Širina kotača [mm]
40	Siva	Odlučan	F003001	95	44	31

05

### ⊕ Riex GC47 kotačič za namještaj s mekim klizačem

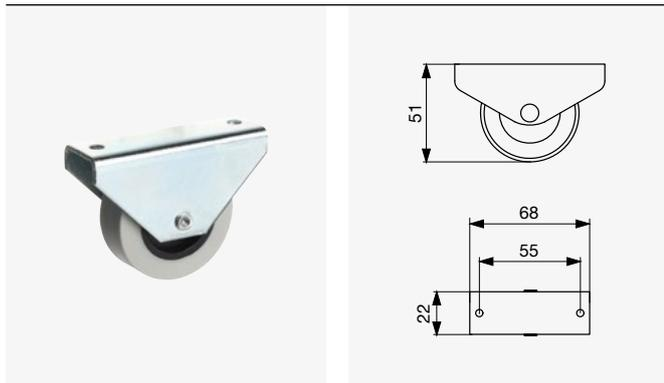

Promjer [mm]	Boja	Izgradnja	Kod	Nosivost [kg]	Visina [mm]	Širina kotača [mm]
45	Siva	Fiksna	F003002	90	51	22

### ⊕ Riex GC48 kotačič za namještaj

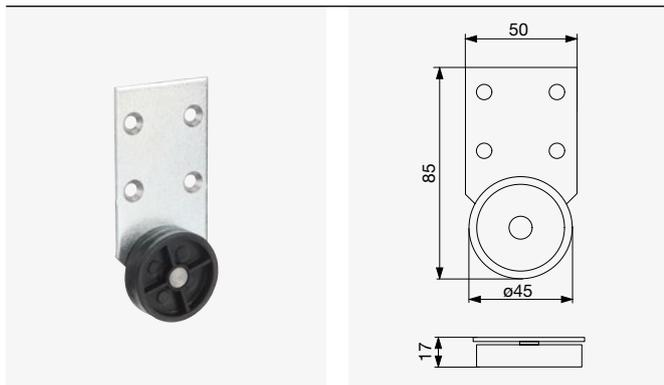

Promjer [mm]	Boja	Tip	Kod	Nosivost [kg]	Visina [mm]	Širina kotača [mm]
45	Sivo	Fiksno	F003007	60	85	17

### ⊕ Riex GC50 kotačič za namještaj

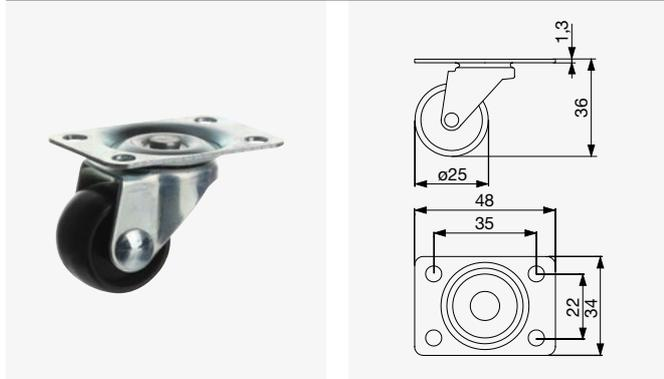

Promjer [mm]	Boja	Izrada	Kod	Nosivost [kg]	Visina [mm]	Širina gazišta [mm]	Ploča [mm]
25	Crno	Okretanje	F001697	12	36	15	48 × 34 × 1,3

## ⊕ Riex GC51 kotačić za namještaj s mekim navojem

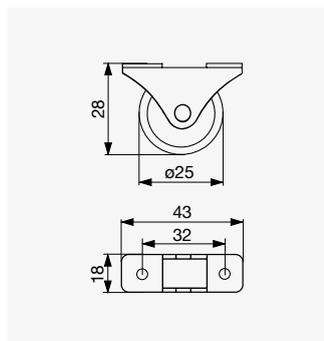

⊕ F000856

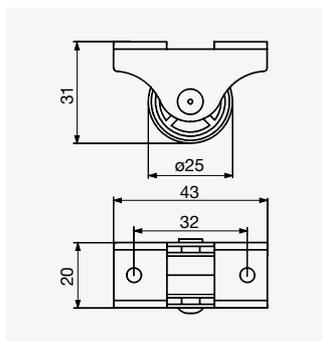

⊕ F000857

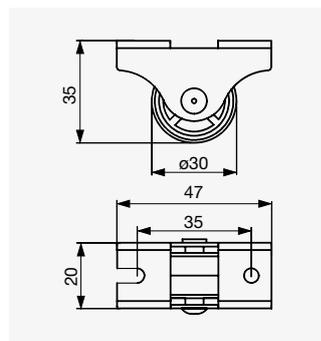

⊕ F000858

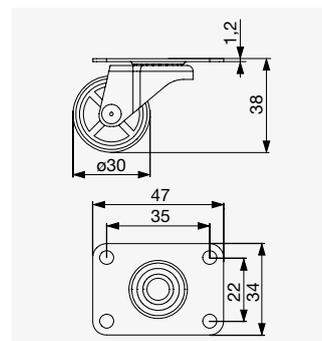

⊕ F000859

Promjer [mm]	Boja	Izgradnja	Kod	Nosivost [kg]	Visina [mm]	Širina kotača [mm]	Ploča [mm]
25	Crna	Fiksni	F000856	25	28	18	43 × 18
	Siva	Fiksni	F000857		31	20	43 × 20
30	Siva	Fiksni	F000858	30	35	20	47 × 20
		Tokarenje	F000859		38	20	47 × 34

## ⊕ Riex GC52 kotačić za namještaj s mekim gazištem



● Siva



● Siva s kočnicom

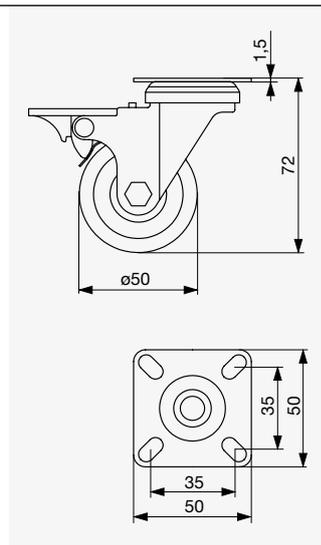

⊕ ø50

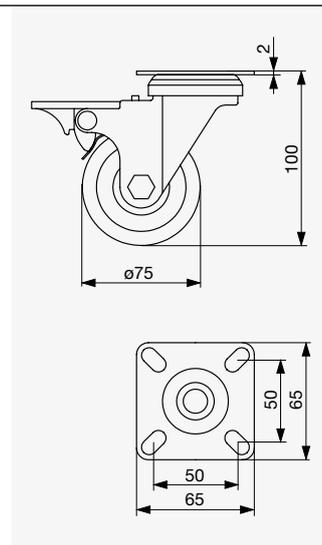

⊕ ø75

Promjer [mm]	Boja	Kočnice	Kod	Nosivost [kg]	Visina [mm]	Širina gazišta [mm]	Ploča [mm]
50	Siva	Ne	F001680	30	72	16,5	50 × 50 × 1,6
		Da	F001681				
75	Siva	Ne	F001682	60	100	23	65 × 65 × 1,8
		Da	F001683				

05

## ⊕ Riex GC53 kotačić za namještaj s mekim gazištem

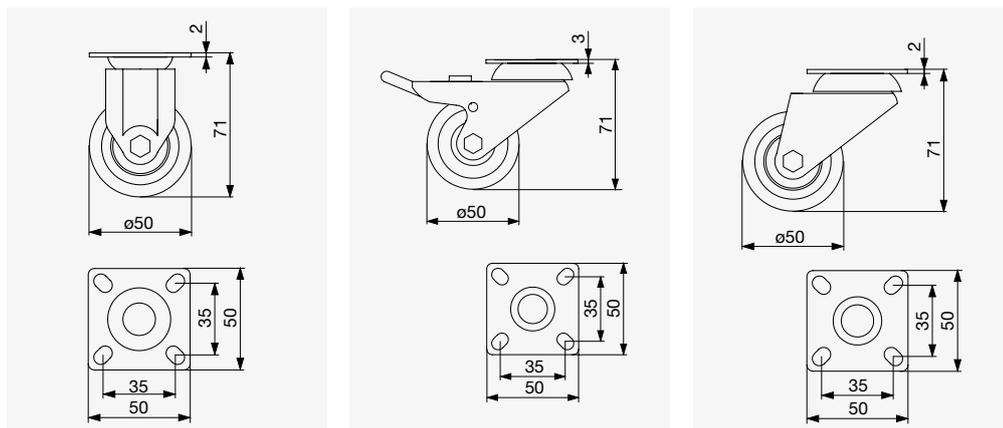

⊕ F001686

⊕ F001685

⊕ F001684

Promjer [mm]	Boja	Izgradnja	Kočnice	Kod	Nosivost [kg]	Visina [mm]	Širina gazišta [mm]	Ploča [mm]
50	Siva	Določeno	No	F001684	50	71	19	50 × 50 × 1,8
			Da	F001685				
		Okretanje	No	F001686				

## ⊕ Riex GC62 kotačić za namještaj s mekim gazištem



● Siva

● Siva s kočnicom

Promjer [mm]	Boja	Kočnice	Kod	Nosivost [kg]	Visina [mm]	Širina gazišta [mm]	Ploča [mm]
75	Siva	Ne	F001692	70	124	32	60 × 95 × 3,5
		Da	F001693				



## ● Riex GC64 kotačić za namještaj s mekim gazištem



● Siva

● Siva s kočnicom

Promjer [mm]	Boja	Kočnice	Kod	Nosivost [kg]	Visina [mm]	Širina gazišta [mm]	Ploča [mm]
100	Siva	Ne	<b>F001690</b>	60	125	24	70 × 58 × 2,5
		Da	<b>F001691</b>				

## ● Tente Alpha kotačić za namještaj s mekim gazištem

TENTE

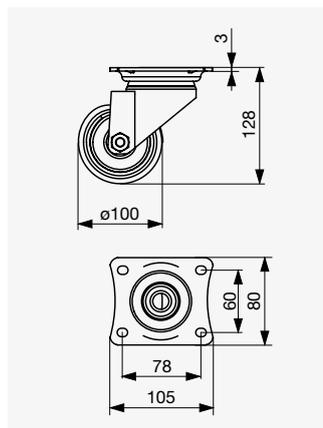

① F003515

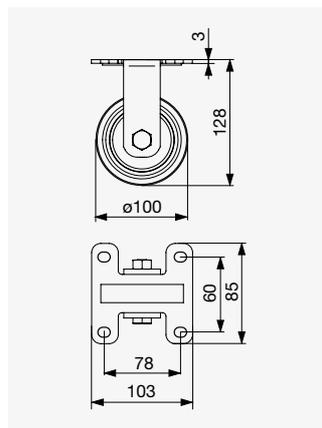

① F003516

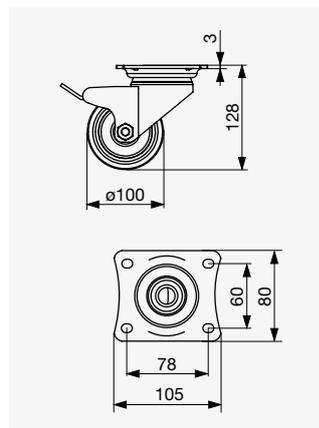

① F003517

Promjer [mm]	Boja	Izgradnja	Kočnice	Kod	Nosivost [kg]	Visina [mm]	Širina gazišta [mm]	Ploča [mm]
100	Sivo	Okretanje	Ne	<b>F003515</b>	220	128	28	80 × 60 × 3
		Odlučan	Ne	<b>F003516</b>				
		Okretanje	Da	<b>F003517</b>				

05

## ● Tente Agila kotačić za namještaj s mekim gazištem

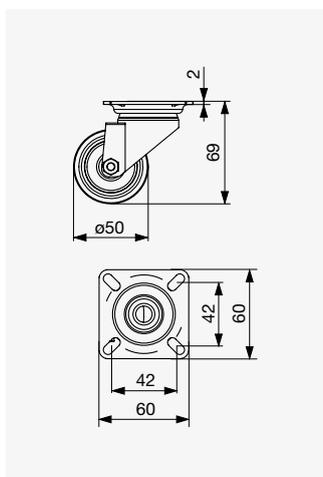
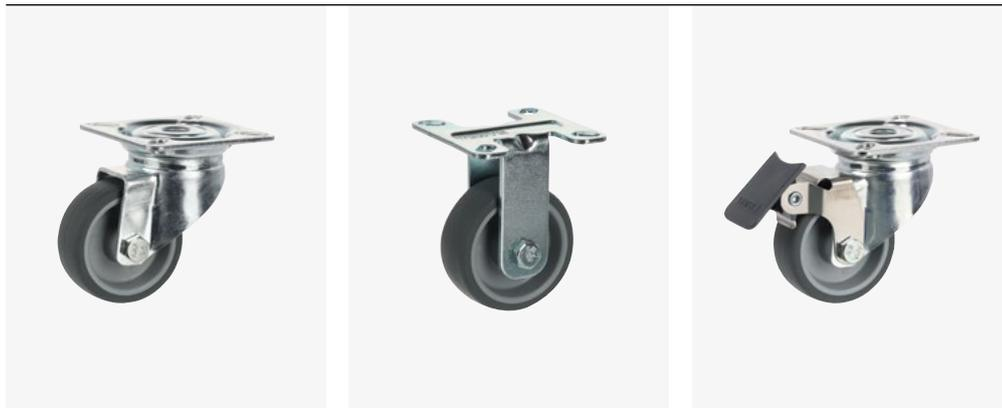

① F003573

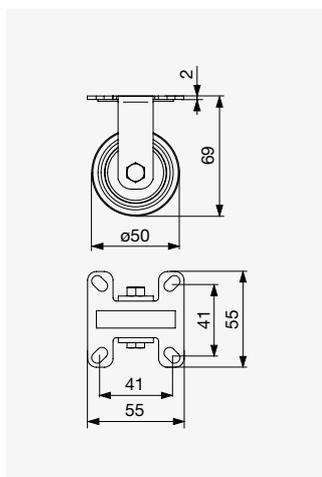

① F003574

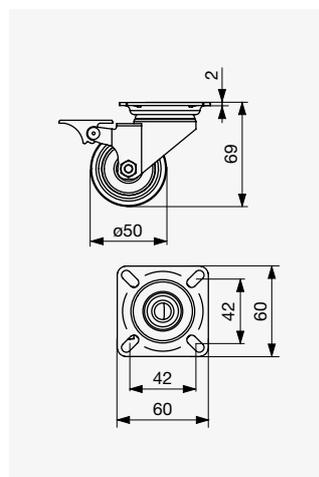

① F003575

Promjer [mm]	Boja	Izgradnja	Kočnice	Kod	Nosivost [kg]	Visina [mm]	Širina gazišta [mm]	Ploča [mm]
50	Sivo	Okretanje	Ne	F003573	80	69	19	60 × 60 × 2
		Fiksna	Ne	F003574				55 × 55 × 2
		Okretanje	Da	F003575				60 × 60 × 2

## ● Tente Agila kotačić za namještaj s mekim gazištem

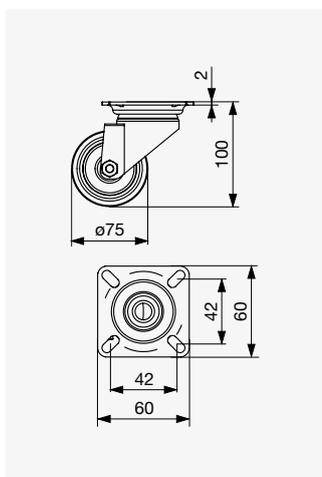
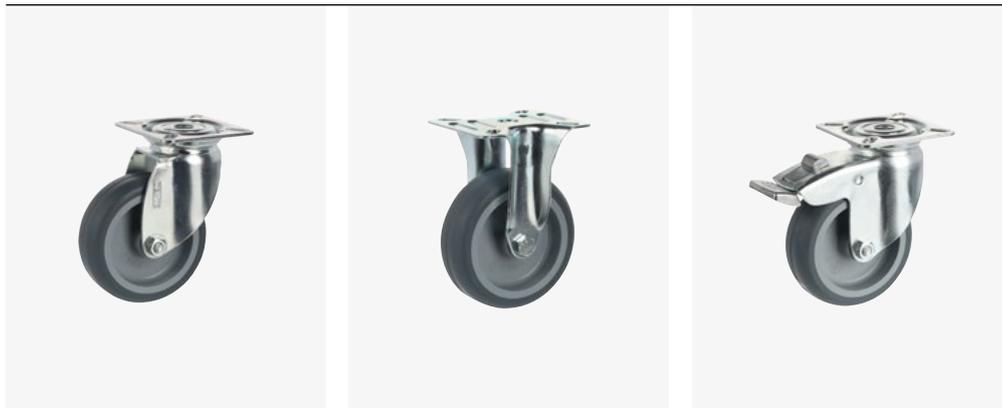

① F003576

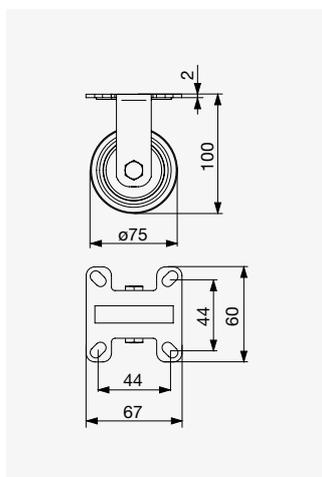

① F003577

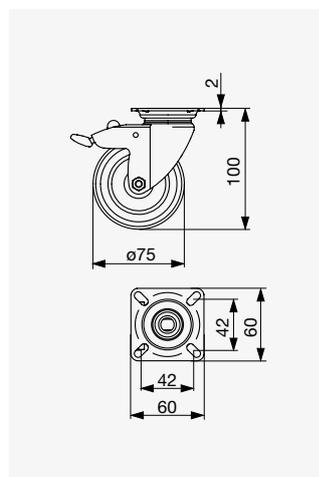

① F003578

Promjer [mm]	Boja	Izgradnja	Kočnice	Kod	Nosivost [kg]	Visina [mm]	Širina gazišta [mm]	Ploča [mm]
75	Sivo	Okretanje	Ne	F003576	150	100	25	60 × 60 × 2
		Fiksni	Ne	F003577				60 × 67 × 2
		Okretanje	Da	F003578				60 × 60 × 2

01  
02  
03  
04  
05  
06  
07  
08  
09  
10  
11  
12  
13  
14  
15  
16  
17  
18

# Noge i vodilice za stolove

U ovom poglavlju usredotočit ćemo se na elemente namještaja za proizvodnju različitih vrsta stolova. Kvalitetne noge ključne su za stabilnost svakog stola i za tu potrebu preporučujemo ER60 noge za stolove s izvrsnom bočnom stabilnošću. Asortiman je dodatno nadopunjen drugim vrstama nogu za stolove u različitim materijalima, završnim obradama ili visinama, širokim rasponom okova za proizvodnju stolova na razvlačenje i specifičnih spojnica za stolove.



---

● Noge za stol	6.3
● Poettker Sustavi vodilica za stolove	6.7
Poettker Okovi	6.8
za sklopive stolove	6.10

---

# Noge za stolove

06

- ER40 – Okrugla metalna noga kao ekonomično rješenje
- ER60 – Najbolje rješenje među okruglim metalnim nogama. Patentirani dizajn i jedinstvena bočna stabilnost.
- EA60 i EA80 – aluminijske noge kvadratnog profila
- GS42 i GS43 – dizajnerski model u atraktivnoj crnoj boji, napravljen od žica debljine 10 mm. Također su dostupne kao noge za namještaj i male stolove.

## ➔ Riex ER40 noga za stolove **ECONOMY**



● Krom

- Ekonomično rješenje noge za stolove
- Obična ploča od materijala debljine 1,5 mm
- Dostupna u 6 završnih površinskih obrada



● Mat krom ● Mat crna ● Siva ○ Sjajno bijela



● Imitacija nehrđajućeg čelika

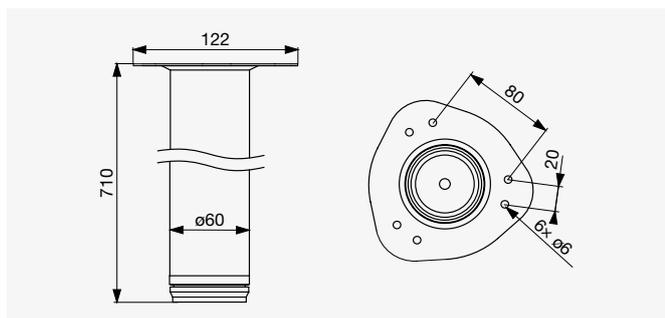

Boja	Visina [mm]	Kod	Podešavanje visine [mm]
Krom	710	F000922	+15
Mat krom		F003049	
Mat crna		F000924	
Siva		F000926	
Sjajno bijela		F000925	
Imitacija nehrđajućeg čelika		F000923	

## ● Riex ER60 noga za stol



● Imitacija nehrđajućeg čelika

ER60 je najbolji izbor kada su u pitanju noge za stolove.

### Glavne prednosti obuhvataju:

- Izvrsna bočna stabilnost [više od 80% veća od konvencionalnih tipova]
- Jedinstveno patentirano i vrlo čvrsto spajanje na ploču
- Nema postupnog popuštanja tijekom vremena kao kod drugih vrsta
- Visokokvalitetni čelik debljine 1,1 mm za nogu, visokokvalitetni materijal za plastični element za rektifikaciju tj ispravljanje].
- Širok raspon [7 završnih obrada i 3 visine]

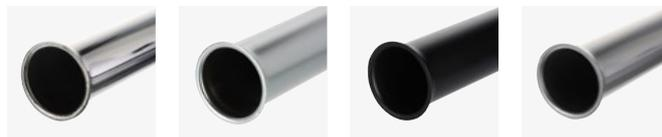

● Krom

● Mat krom

● Mat crna

● Srebrna



○ Sjajno bijela

● Siva

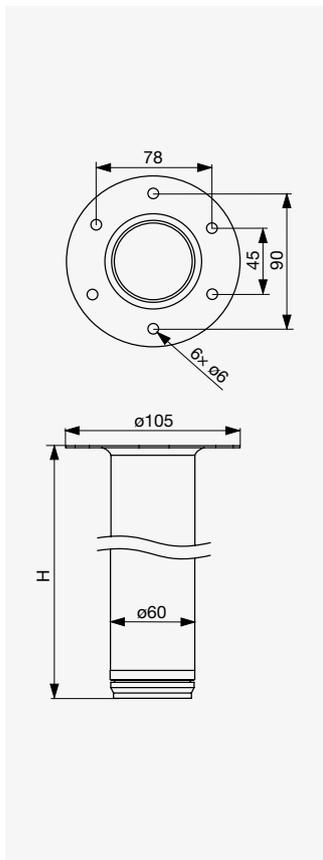

Boja	Visina H [mm]	Kod	Podešavanje visine [mm]
Imitacija nehrđajućeg čelika	710	F000903	+25
	820	F000904	
	1100	F000905	
Krom	710	F000891	
	820	F000892	
	1100	F000893	
Mat krom	710	F003616	
	820	F003617	
	1100	F003618	
Mat crna	710	F000894	
	820	F000895	
	1100	F000896	
Srebrna	710	F000897	
	820	F000898	
	1100	F000899	
Sjajno bijela	710	F000900	
	820	F000901	
	1100	F000902	
Siva	710	F000890	

### ⊕ Riex EA60 noga za stolove

06

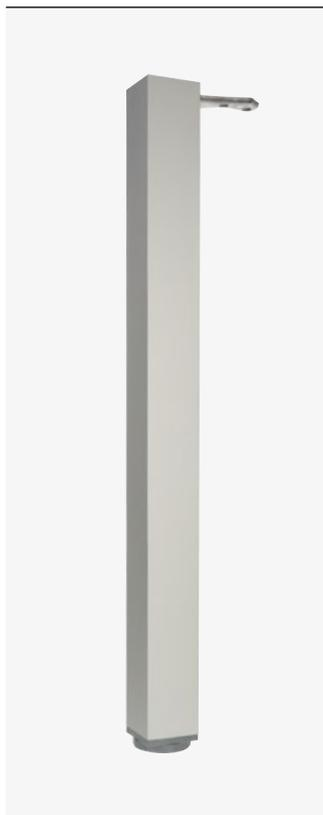

● Anodizovani aluminij

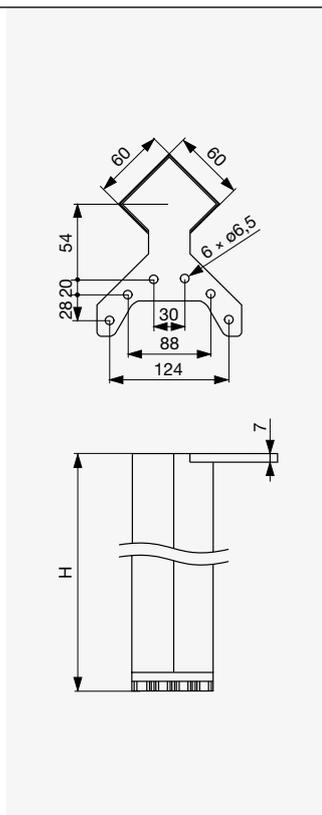

● Imitacija nehrđajućeg čelika

● Mat crna

○ Sjajno bijela

- Materijal od aluminija
- Nevidljivi spoj
- Profil 60 x 60 mm
- Dostupno u 4 završne obrade
- Čvrsti lijevani nosač od legure cinka

Boja	Visina H [mm]	Kod	Podešavanje visine [mm]
Anodizovani aluminij	710	F000910	+20
	820	F000911	
	1100	F000912	
Imitacija nehrđajućeg čelika	710	F000913	
	820	F000914	
	1100	F000915	
Mat crna	710	F000916	
Sjajno bijela	710	F000917	

### ⊕ Riex EA80 noga za stolove



● Mat crna

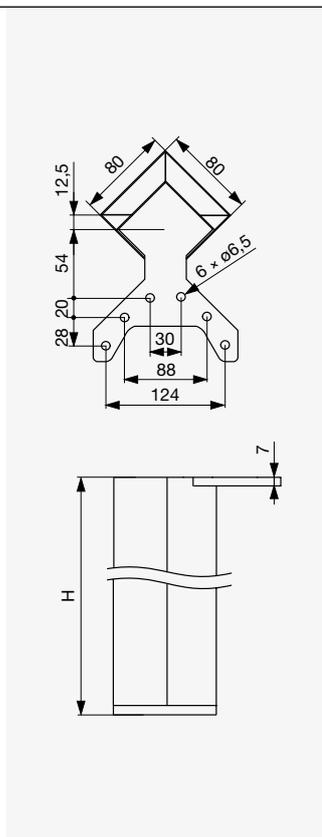

● Anodizovani aluminij

● Imitacija nehrđajućeg čelika

○ Sjajno bijela

- Materijal od aluminija
- Nevidljivi spoj
- Profil 60 x 60 mm
- Dostupno u 4 završne obrade
- Čvrsti lijevani nosač od legure cinka

Boja	Visina [mm]	Kod	Podešavanje visine [mm]
Anodizovani aluminij	710	F000918	+20
Imitacija nehrđajućeg čelika	710	F000919	
Mat crna	710	F000920	
Sjajno bijela	710	F000921	



## ⦿ Riex GS43 noga za stol i namještaj

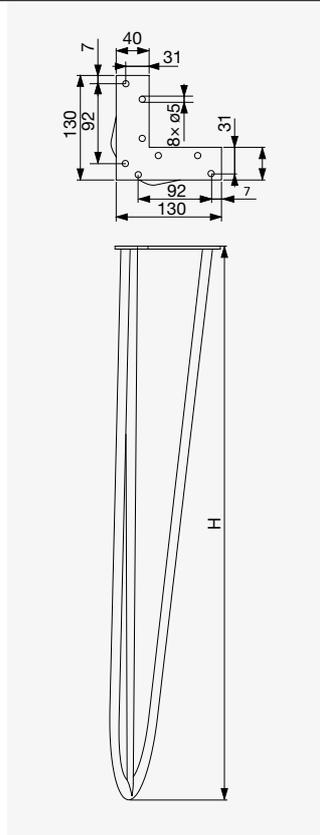

- ø10 mm zavarena čelična žica
- 3 mm debljina montažne ploče

Boja	Visina H [mm]	Kod	Podešavanje visine [mm]
Black	710	F002847	
	400	F002846	+2
	130	F002845	

## ⦿ Riex GS42 noga za stolove i namještaj

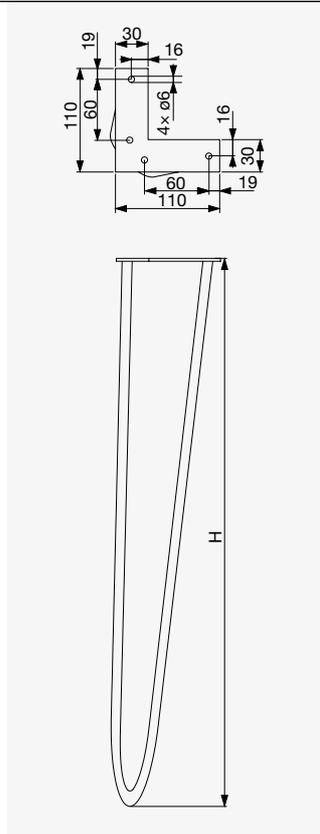

- ø10 mm zavarena čelična žica
- 3 mm debljina montažne ploče

Boja	Visina H [mm]	Kod	Podešavanje visine [mm]
Black	710	F002852	
	400	F002851	×
	130	F002850	

# Poettker Sustavi vodilica za stolove

06

- Poettker – klasična marka u svijetu stolnih produžetaka
- Cjelovito rešenje – vodilice + dodatna oprema
- Moguće je poručiti bilo koje posebno rješenje



## ● Poettker klasični vodilice za stolove



- Rješenje za ekstra dugačak stolove
- Visoka nosivost zahvaljujući debljini materijala od 1,75 i 2 mm
- Set vodilica za stolove [par]

### Primjer kompleta:

- Vodilice za stolove
- Preklopni mehanizam – eg. F004788
- Poettker spojnice za stolove – eg. F004842
- Metalne tiple F004844
- Bravica sa zateznom oprugom F004846

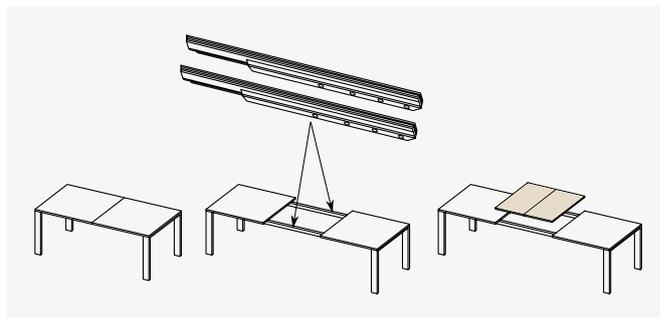

Duljina vodilica [mm]	Umetci	Kod	Kočnica	Sinkro	Kapacitet [kg]
650	4× 500 mm	F004781	No	No	90
740	3× 500 mm	F004782			

## ● Poettker kombinirani vodilice za stolove



- Kombinacija aluminijskih i čeličnih profila
- Set vodilica za stolove [par]

### Primjer kompleta:

- Vodilice za stolove
- Preklopni mehanizam – eg. F004788
- Poettker spojnice za stolove – eg. F004842
- Metalne tiple F004844

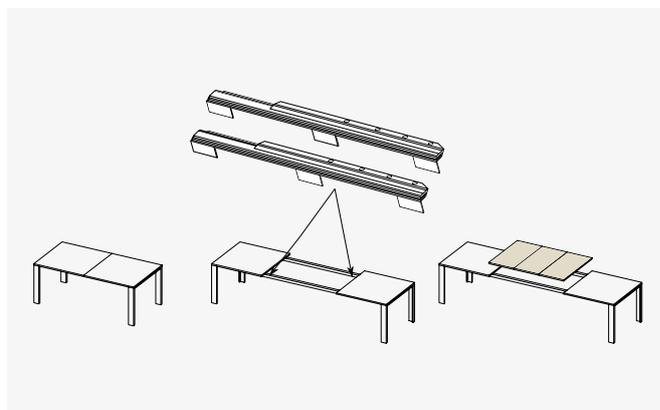

Duljina vodilica [mm]	Umetci	Kod	Kočnica	Sinkro	Kapacitet [kg]
980	3× 500 mm	F004786	Yes	Yes	90

## ● Poettker osnovni napredni vodicice za stolove

06



- Svi modeli sa kočnicama i sa sinkronizacijom
- Set vodicica za stolove [par]

Idealno za komplet:

- Vodicice za stolove
- Preklopni mehanizam – eg. F004788
- Poettker spojnice za stolove – eg. F004842
- Metalne tiple F004844

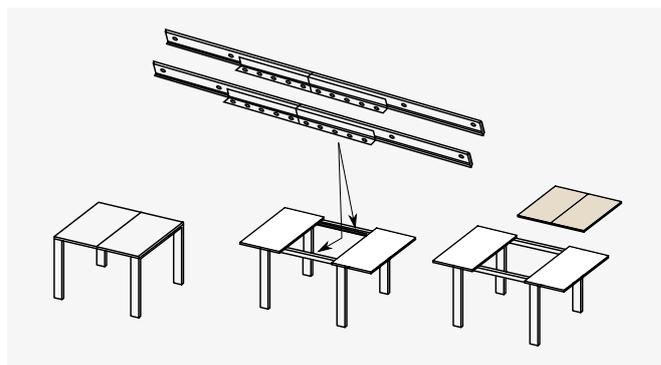

Duljina vodicica [mm]	Umetci	Kod	Kočnica	Sinkro	Kapacitet [kg]
850	1 × 500 mm	F004785			
1150	2 × 400 mm	F004784	yes	yes	90
1350	2 × 500 mm	F004783			

## ● Poettker osnovni vodicice za stolove



- Osnovno rješenje bez kočnice i bez sinkronizacije
- Set vodicica za stolove [par]

Idealno za komplet:

- Vodicice za stolove
- Preklopni mehanizam – eg. F004788
- Poettker spojnice za stolove – eg. F004842
- Metalne tiple F004844
- Bravica sa zateznom oprugom F004846



Model na video snimci je sa kočnicom i sa sinkronizacijom.

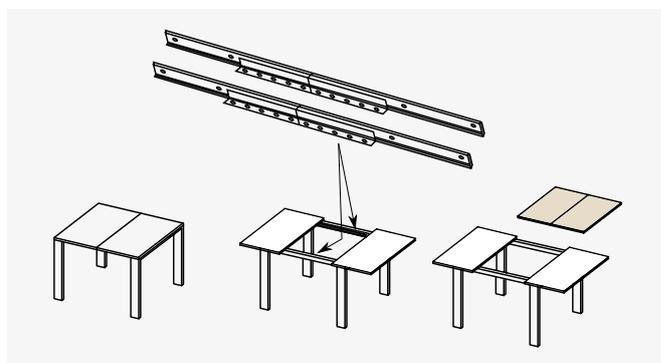

Duljina vodicica [mm]	Umetci	Kod	Kočnica	Sinkro	Kapacitet [kg]
680	1 × 500 mm	F004847	no	no	60

## ● Poettker SFM preklopni mehanizam



- Jednostavno rješenje i laka ugradnja

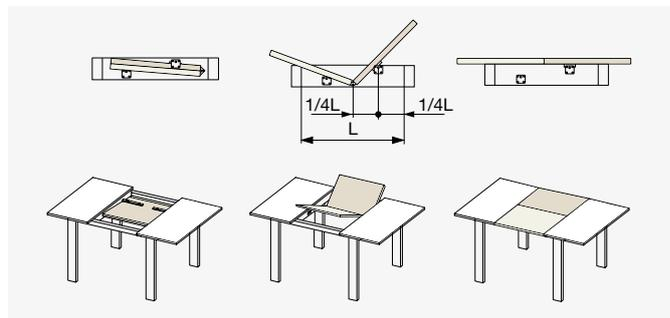

Type

Kod

Set od 4 komada

F004787

## ● Poettker FM – preklopna šipka za zaustavljanje



- Preklopni mehanizam sa kočnicom
- Idealno za uporabu sa F004841 [L plastična klackalica]



Primjer uporabe FM preklopne šipke za zaustavljanje

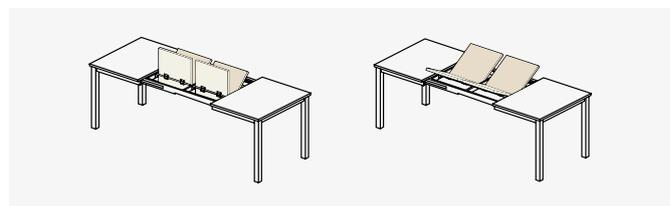

Duljina šipke [mm]

Kod

1 000

F004789

## ● Poettker preklopna šipka



- Otvaranje 180°
- Lijevani cink pod pritiskom
- Idealno za uporabu sa F004841 [L plastična klackalica]
- Mogućnost rezanja
- Slično rješenje sa F004789

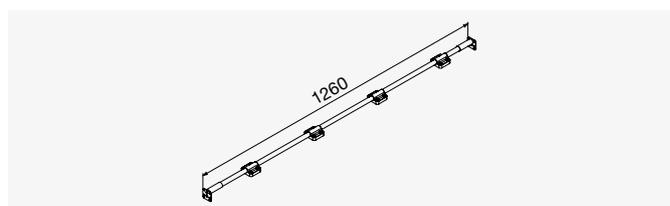

Duljina šipke [mm]

Kod

1 260

F004788

## ● Poettker spojnice za stolove



- Otvaranje 180°
- Lijevani cink pod pritiskom

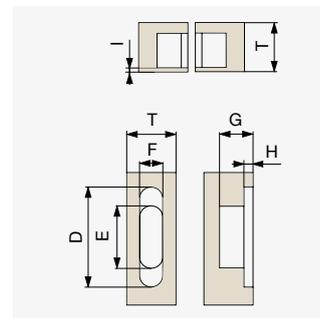
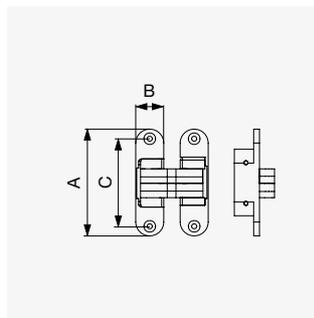

Debljina ploče [mm]	Kod
18-25	F004843
22-30	F004842
28-40	F004887
35-50	F004888

① F004843

	A	B	C	D	E	F	G	H	I	T
F004843	44,3	13	31	44,5	19	13,5	19	5	2,8	18-25
F004842	60,7	12,6	46,5	61,5	32	13,5	19	6,5	2,8	22-30
F004887	69,9	15,7	51	70	34	16	24	7,5	2,8	28-40
F004888	95	17,8	73,6	94,3	54,6	19	28,5	9,5	2,8	35-50

● Riex EZ01  
Kutni spoj za stolove

RiEX



① F004848

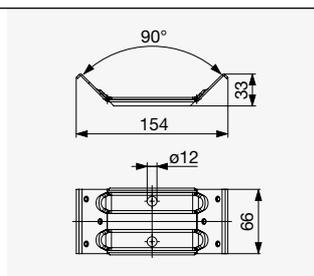

① F004848

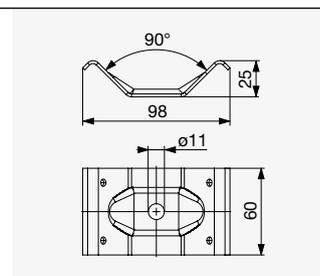

① F004849



① F004849



① F004850

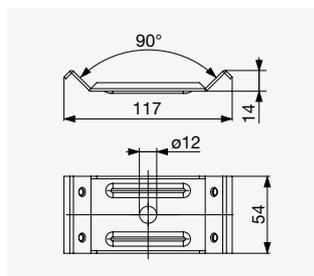

① F004850

Visina [mm]	Duljina [mm]	Kod	Spojni otvor [mm]
66	154	F004848	2 × ø12 mm
60	98	F004849	1 × ø11 mm
54	117	F004850	1 × ø12 mm

● Poettker dodatna oprema



① F004841

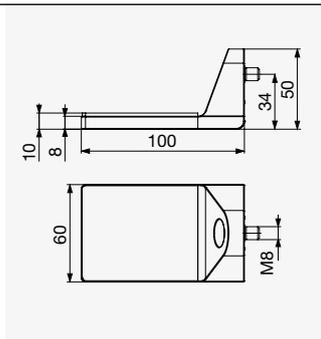

① F004841



① F004844

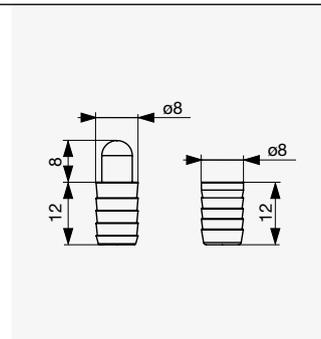

① F004844



① F004845

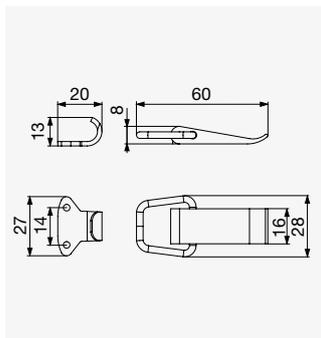

① F004845



① F004846

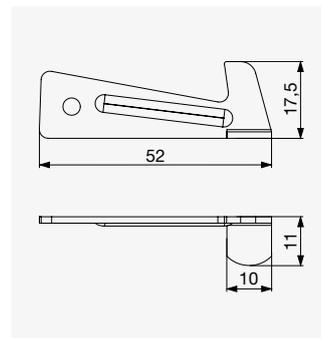

① F004846



① F004889

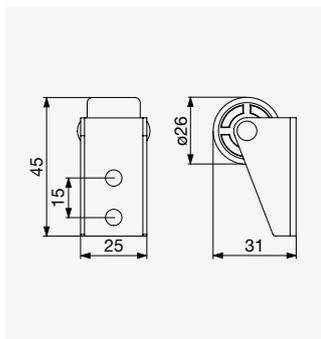

① F004889

Tip	Kod
L plastična klackalica	F004841
Metalne tiple / izolator	F004844
Zatezač sa zateznom oprugom	F004845
Kukasti vijak	F004846
Vertikalni spojni kotačić	F004889

# Brave, cilindri i magneti

U ovom poglavlju nudimo veliki izbor brava za namještaj, magneta i zasuna za učvršćivanje vrata u zatvorenom položaju. Naći ćete brave za različite vrste vrata, npr. za jednokrilna i dvokrilna vrata, klizna vrata, staklena vrata itd. Najopsežniji dio ovog poglavlja posvećen je bravama serije EP sa izmjenjivim cilindričnim jezgrama. Ove brave omogućuju kupcu da dizajnira projekte s mnogo kombinacija ključeva, a zahvaljujući posebnim vrstama ključeva s unutarnjim valovitim utorom i bočnim udubljenjima [serija EP20] nude visoku sigurnost.





---

● Riex EP Brave za namještaj	7.3
Riex EP Brave za namještaj	7.4
Riex EP20 Jezgra cilindara	7.11
Riex EP10 Jezgra cilindara	7.13
Dodaci za jezgre cilindara	7.14

---

● Riex EZ20 Brave za namještaj	7.15
--------------------------------	------

---

● Vijci, magnetski zasuni i dodaci	7.19
------------------------------------	------

---

# Riex EP Brave za namještaj

- Zamjenjive jezgre cilindara
- Mnogo mogućnosti kombiniranja umetaka i ključeva
- 2 razine cilindričnih jezgri EP10 i EP20
- Cilindarske jezgre kompatibilne sa svim tijelima brava

07



## ⊕ Riex EP50 Brava za ladicu

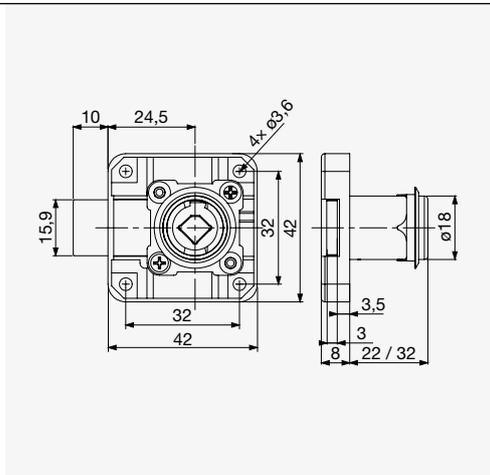

Duljina cilindra [mm]	Strana primjene	Kod
22	Desna	F002081
	Lijeva	F002082
	Gore / Dolje	F002083
32	Gore / Dolje	F002868

- Poniklano
- Uključuje rozetu
- Za potpuni set upotrijebite profil pločicu F002092
- Za kompletan set dodajte jezgru cilindra str. 7.11

## ⊕ Riex EP52 Brava za ladice s plastičnim tijelom

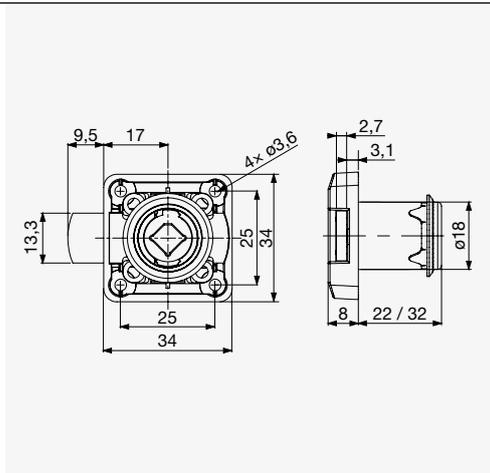

Duljina cilindra [mm]	Strana primjene	Kod
22	Desna	F002085
	Lijeva	F002086
	Gore / Dolje	F002084
32	Gore / Dolje	F002869

- Poniklano / plastično tijelo
- Uključuje rozetu
- Za potpuni set upotrijebite protuudarnu ploču F002092
- Za kompletan set dodajte jezgru cilindra str. 7.11

## ⊕ Riex EP55 Brava s automatskim zaključavanjem

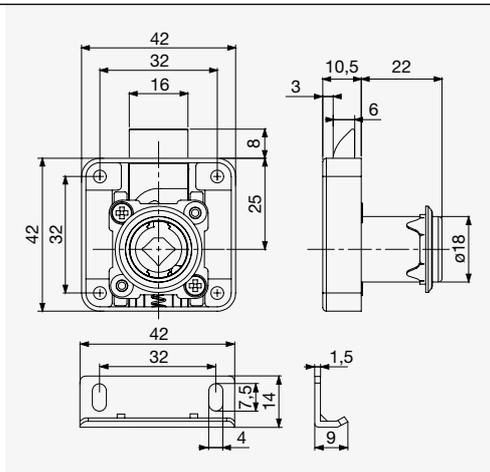

Strana primjene	Kod
Gore / Dolje	F002087

- Poniklano
- Uključuje rozetu i protuudarnu ploču
- Za kompletan set dodajte jezgru cilindra str. 7.11

## ⊕ Riex EP60 Brava za prednju središnju prečku

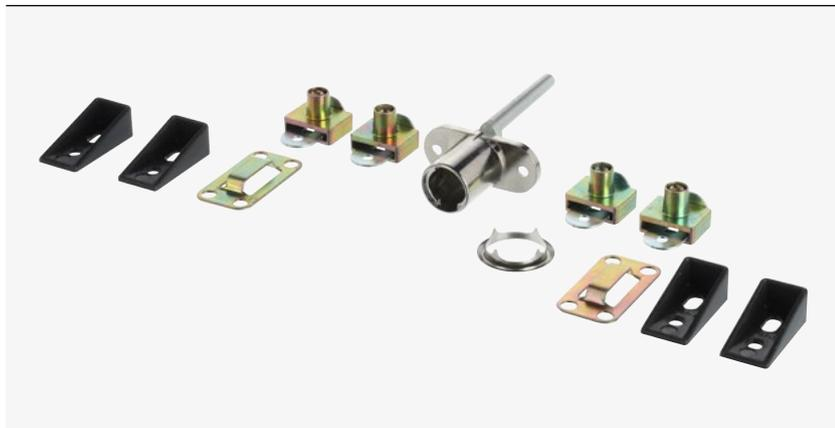

Tip	Kod
Za 4 ladice [bez prečke]	F002088

07

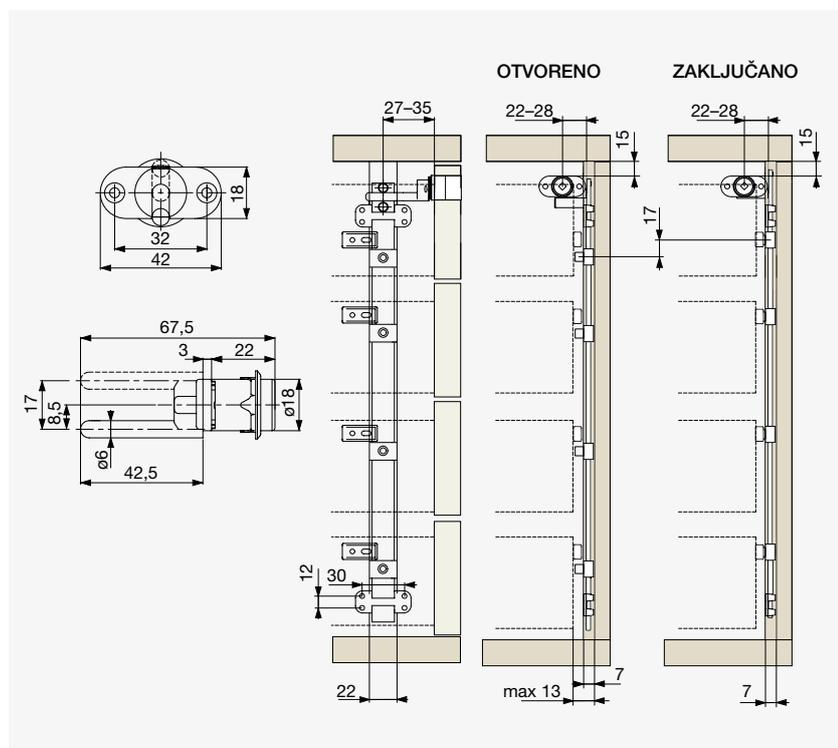

- Poniklano
- Uključuje rozetu i protuudarnu ploču
- Za kompletan set dodajte jezgru cilindra str. 7.11

## ⊕ Riex EP60 Profil za središnju bravu

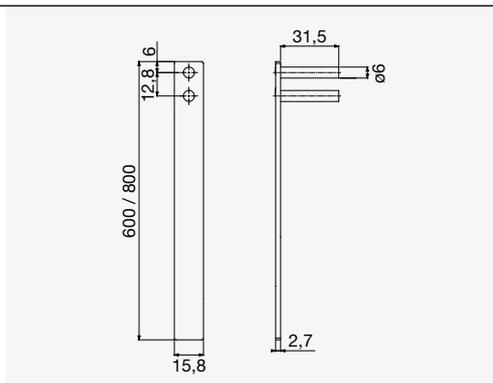

Duljina [mm]	Kod
600	F002089
800	F002090

## ⊕ Riex EP60

### Dodaci za središnju bravu

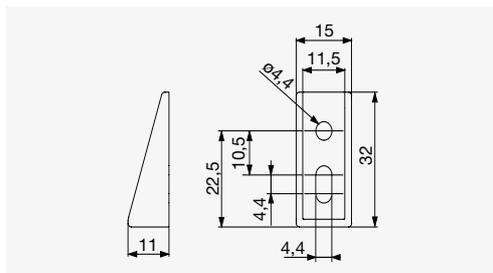
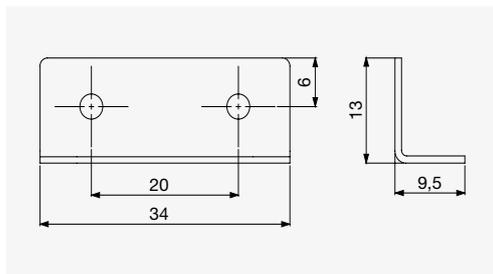
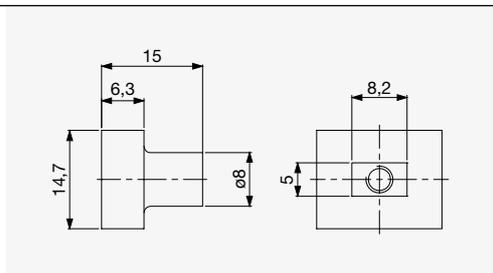

Tip	Kod
Dodatna igla	F002091
L pločasti nosač*	F002092
Nosač za blokiranje	F002093

\* Drugi model udarne ploče F002043 – videti p. 7.19

## ⊕ Riex EP59

### Brava sa polugom

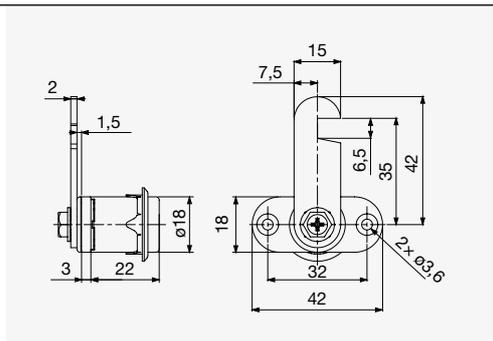

Tip	Kod
Sa kukom [51 mm]	F002096
Sa pločicom [49 mm]	F002097

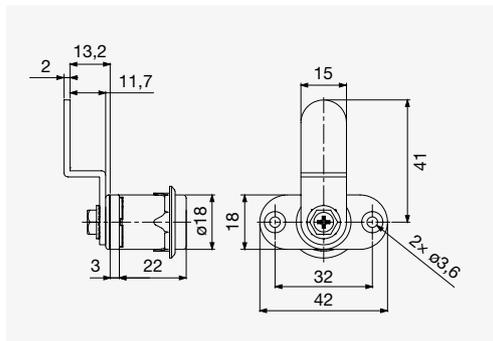

- Poniklano
- Uključuje rozetu i protuudarnu ploču
- Za kompletan set dodajte jezgru cilindra str. 7.11

**⊕ Riex EP58**  
**Brava**

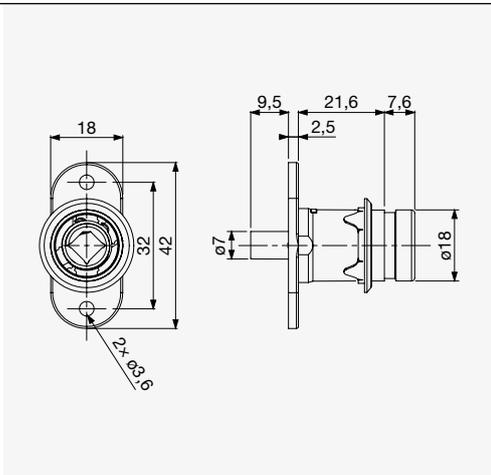

Tip	Kod
Brava	F002094

- Poniklano
- Uključuje rozetu
- Primjenjuje se na kliznim vratima
- Za kompletan set dodajte jezgru cilindra str. 7.11

07

**⊕ Riex EP58**  
**Brava sa L pločicom**

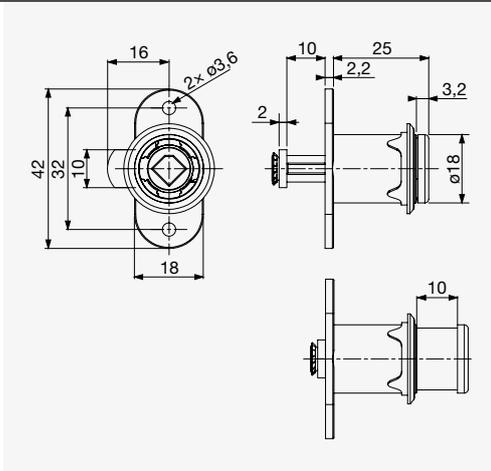

Tip	Kod
Brava	F002095

- Poniklano
- Uključuje rozetu
- Primjenjuje se na kliznim vratima
- Za kompletan set dodajte jezgru cilindra str. 7.11

**⊕ Riex EP57**  
**Brava i kuka**

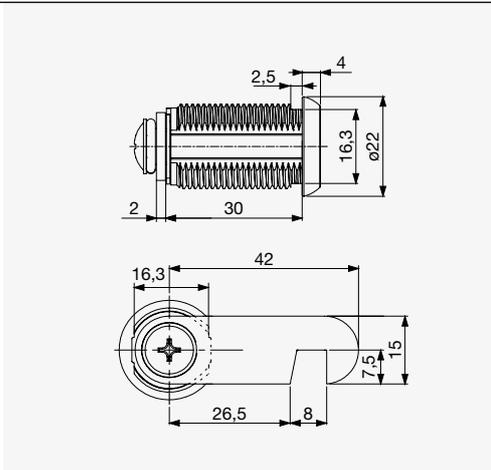

Tip	Kod
S kukom [30 mm]	F002098

- Poniklano
- Za kompletan set dodajte jezgru cilindra str. 7.11







## ⊕ Riex EP71

### Brava za staklena vrata bez bušenja

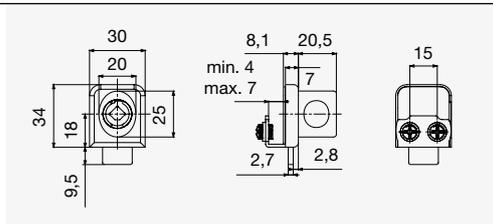

Debljina stakla [mm]	Broj krila	Kod
4-7	1	F002099
	2	F002100

⊕ F002099

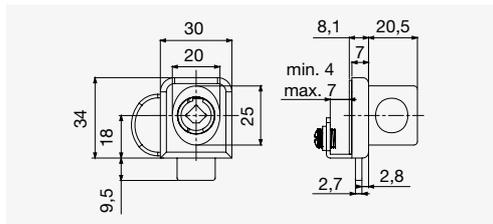

- Poniklano
- Za kompletan set dodajte jezgru cilindra str. 7.11

⊕ F002100

## ⊕ Riex EP73

### Brava za bušena staklena vrata

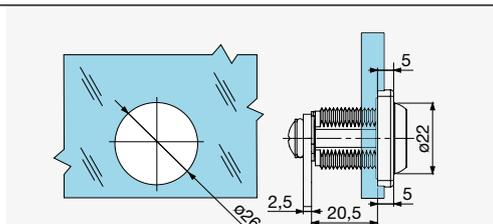

Debljina stakla [mm]	Broj krila	Kod
4-14	1	F002102
	2	F002103

⊕ F002102

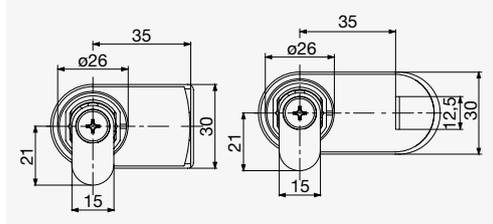

- Poniklano
- Neophodno izbušiti rupu  $\varnothing 22$  mm
- Za kompletan set dodajte jezgru cilindra str. 7.11

⊕ F002103

## ⊕ Riex EP72

### Brava za staklena klizna vrata bez bušenja

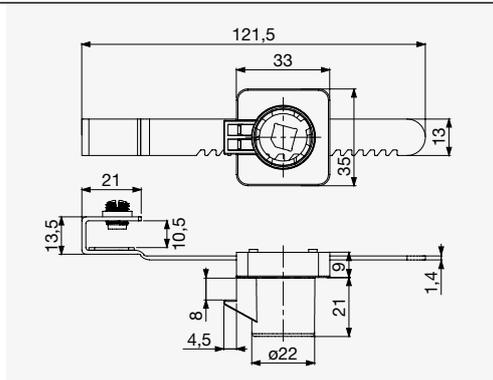

Debljina stakla [mm]	Kod
4-9	F002101

- Poniklano
- Uključuje rozetu
- Za kompletan set dodajte jezgru cilindra str. 7.11

# Riex EP 20 Jezgre cilindara

- Poboljšane jezgre cilindara i ključevi s unutarnjim valovitim utorom i bočnim udubljenjima
- Visoka razina sigurnosti – zaštita od otvaranja s ključem koji nije odgovarajući ključ
- Više od 3000 kombinacija
- 3 master grupe A, B i X
- Glavna grupa X je bez glavnog ključa

07

## ➔ Riex EP20 Jezgra cilindra s različitim kombinacijama

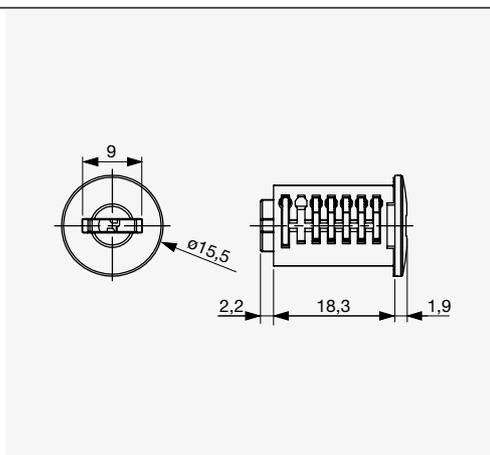
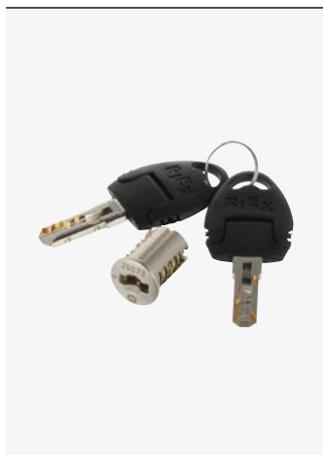

- Više od 3000 različitih kombinacija
- Više kombinacija za projekte na zahtjev
- 2 grupe s različitim glavnim ključevima
- Master grupa X
  - Bez glavnog ključa
  - Rizik od nemogućnosti otključavanja brave ako se ključevi izgube

Master grupa	Cilindar br.	Kod
A	1–100	F002046
	101–200	F002047
	201–300	F002048
	301–400	F002049
	401–500	F002050
B	501–700	F002051
	701–900	F002052
	901–1100	F002053
	1101–1300	F002054
X	2001–4000	F002055

\* Ako kupite 10 komada F002046 dobit ćete 10 različitih jezgri cilindra iz linije A0001–A0100.

\* Ako trebate 150 komada različitih jezgri, trebate kupiti 100 komada F002046 i 50 komada F002047 ili 150 komada F002051.

\* Ako ne želite imati Master grupu, morate je dobiti F002055 – bez mogućnosti otvaranja u nuždi.

## ⊕ Riex EP20 Jezgra cilindra s istim kombinacijama

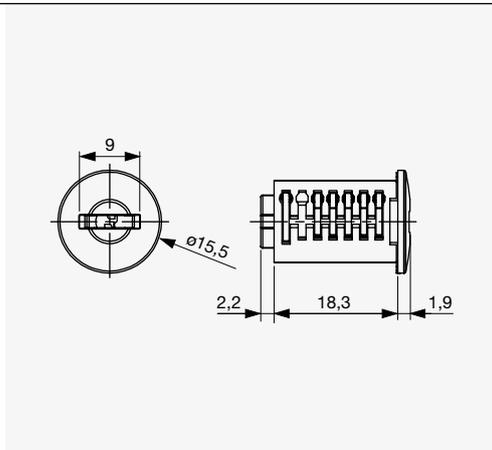

- Moguće naručiti 20 različitih grupa s istim kombinacijama

Master grupa	Cilinder br.	Kod
	5001	F002056
	5002	F002057
	5003	F002058
	5004	F002059
	5005	F002060
	5006	F002061
	5007	F002062
	5008	F002063
	5009	F002064
A	5010	F002065
	5011	F002066
	5012	F002067
	5013	F002068
	5014	F002069
	5015	F002070
	5016	F002071
	5017	F002072
	5018	F002073
	5019	F002074
	5020	F002075

- \* Desna cilindrična jezgra za ured s više brava koje se otvaraju jednim ključem.
- \* Ako imate 5 brava u uredu, kupit ćete 5 komada F002056 i svi će ključevi biti isti.
- \* Provjerite i uzorak situacije na str. 7.14

## ⊕ Riex EP20 Ključ za uklanjanje i glavni ključevi



⊕ Ključ za uklanjanje

⊕ Master

- Ključ za uklanjanje – za uklanjanje jezgre cilindra iz tijela brave. Brava mora biti u otključanom položaju
- Glavni ključ – može se otvoriti svaka brava s cilindričnom jezgrom iz iste glavne grupe

Tip ključa	Master Grupa	Kod
Master	A	F002079
	B	F002080
Ključ za uklanjanje	A+B+X	F002077

# Riex EP 10 Jezgre cilindara

- Osnovna jezgra cilindra sa standardnim ključem
- Ekonomična verzija s 200 kombinacija
- Nije moguće odabrati određenu kombinaciju
- Jedna glavna grupa M1

07

## ⊕ Riex EP10 Jezgra cilindra

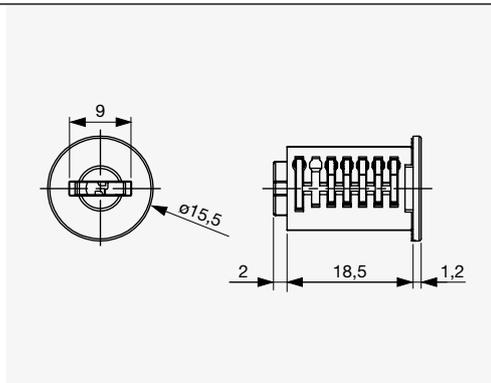

- 200 kombinacija ključeva
- Jednostavan ključ
- Jedna master grupa

Master Grupa	Cilinder br.	Kod
M1	1-200	F002044

## ⊕ Riex EP10 Ključ za uklanjanje i glavni ključevi



- Ključ za uklanjanje – za uklanjanje jezgre cilindra iz tijela brave. Brava mora biti u otključanom položaju
- Glavni ključ – može se otvoriti svaka brava s cilindričnom jezgrom iz iste glavne grupe

Tip ključa	Master Grupa	Kod
Master		F002078
Ključ za uklanjanje	M1	F002076

⊕ Ključ za uklanjanje

⊕ Master

# Dodaci za jezgre cilindara

## ⊕ Riex EP20 / EP10 Ovalni gumb

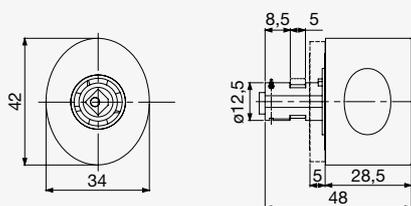

Tip	Kod
Gumb na zaključavanje	F002110

- Poniklano
- Za kompletan set dodajte jezgru cilindra str. 7.11

## Moguća rješenja upotrebom zamjenjivih cilindara EP20 u uredima:

- Kontrola nad kombinacijama tipki – laka zamjenjivost, npr. prilikom premještanja namještaja [također za EP10]
- Mogućnost posjedovanja istog ključa za više brava – prednost posjedovanja jednog ključa za više brava [za stakleni ormar, za ladice stola ili za ormare itd.]

## Primjer:

- Svaki ured sadrži nekoliko ormarića
- Uredski korisnik ima samo jedan ključ za sve ormariće
- Ključevi između ureda su nekompatibilni

Ured 1 – 4x kod F002056  
 Ured 2 – 4x kod F002057  
 Ured 3 – 5x kod F002065  
 Ured 4 – 4x kod F002066



# Riex EZ20 Brave za namještaj

- Osnovna grupa brava za namještaj
- Integrirana jezgra cilindra
- Nema opcije za definiranje kombinacija cilindra / ključeva

## ➤ Riex EZ20 **ECONOMY**

### Brava za ladicu

07

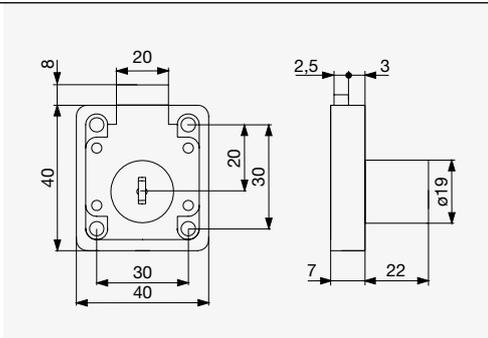

Tip	Kod
Tijelo od cinka	F002030
Tijelo od željeza	F002031

- Uključuje 2 ključa i rozetu

## ➤ Riex EZ20 **ECONOMY**

### Brava na guranje

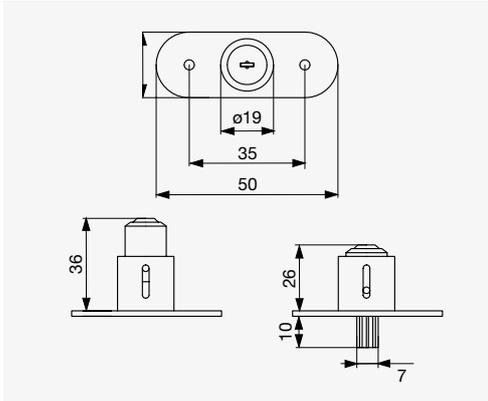

Tip	Kod
Brava	F002042

- Primjena na kliznim vratima
- Uključuje 2 ključa i rozetu

## ➤ Riex EZ20 **ECONOMY**

### Brava za staklena vrata

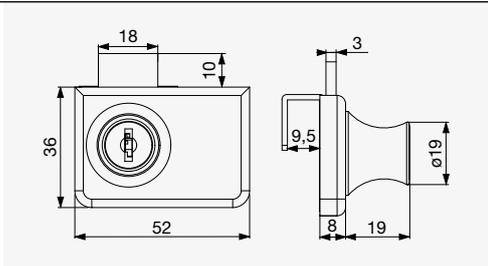

Tip	Kod
Kromirana brava	F002041

- Za debljinu stakla 4–8 mm

## ⊕ Riex EZ20 **ECONOMY**

### Centralna brava

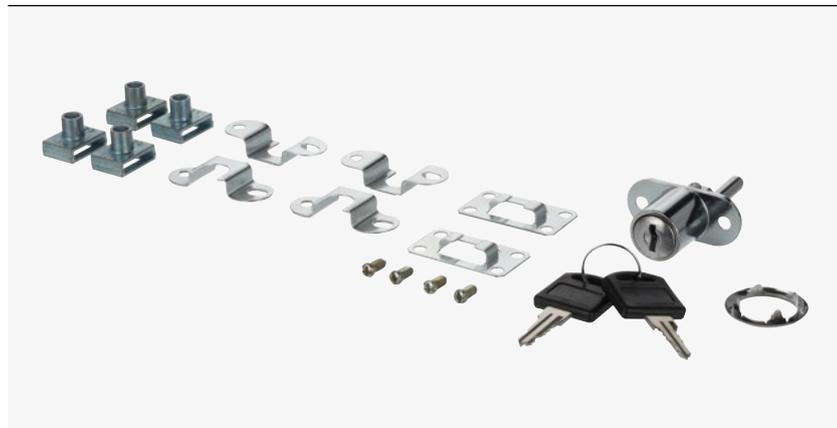

Tip	Kod
Brava bez prečke	F002035

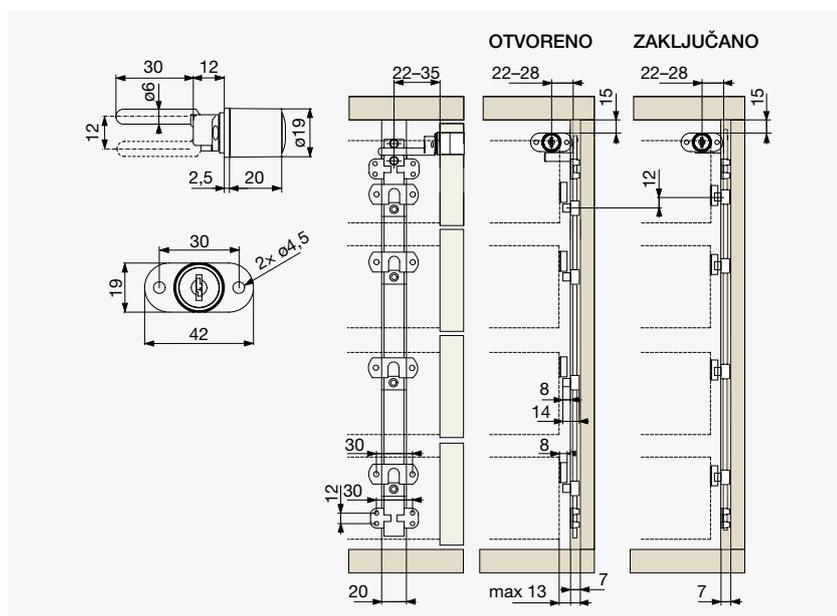

#### Sadrži:

- Bravu
- 2 Ključa
- Rozetu
- Kontraploča [samo s željeznim modelom]

## ⊕ Riex EZ20 **ECONOMY**

### Profil za centralnu bravu

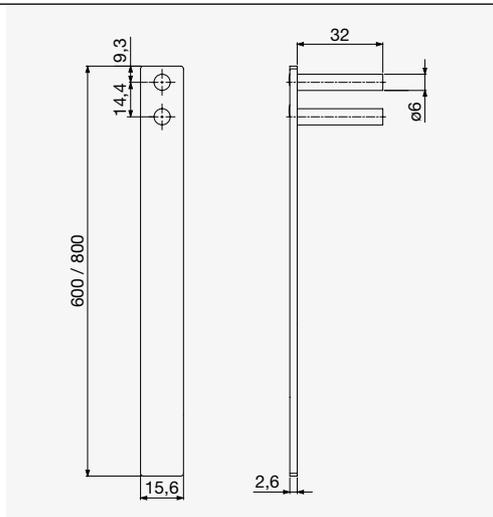

Duljina [mm]	Kod
600	F002036
800	F003039

- Za kombinaciju sa bravom za centralnu šipku

**+** Riex EZ20 **ECONOMY**

**Brava sa ekspandirajućim rezom**



Tip	Kod
Brava bez reza	F002037

07

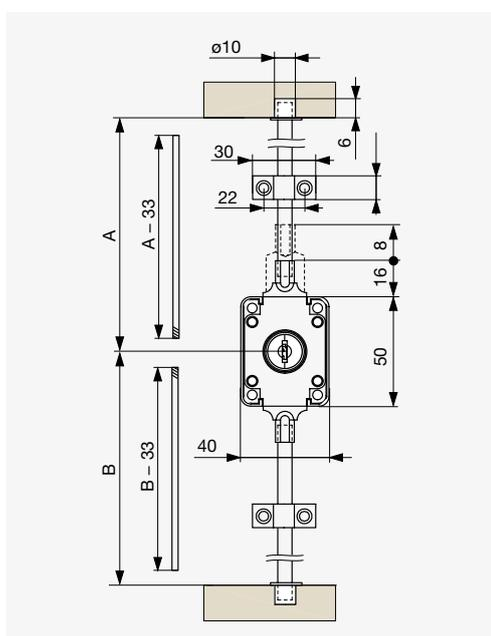
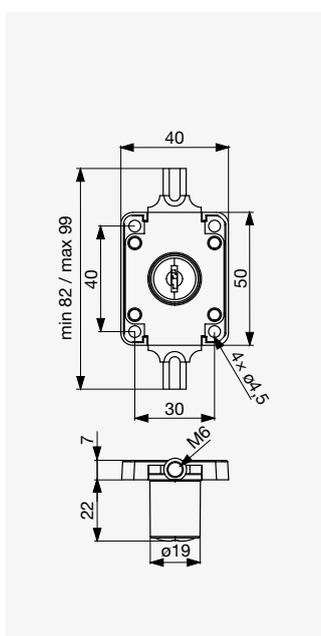

- Uključuje 2 ključa i rozetu
- Opremiti sa dvije reze da se dobije kompletan set

**+** Riex EZ20 **ECONOMY**

**Cijev za bravu sa ekspandirajućim rezom**

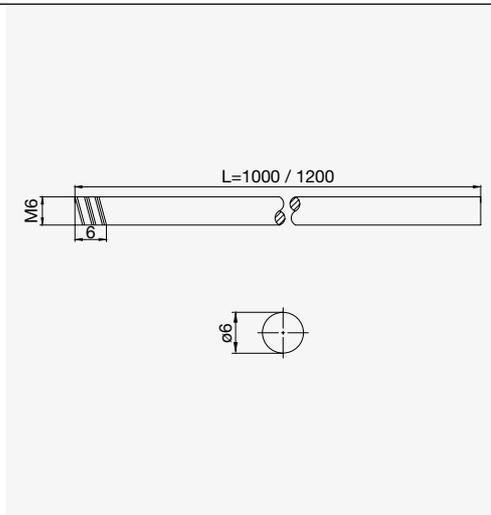

Duljina [mm]	Kod
1000	F002899
1200	F002900



## ⊕ Riex EZ20 **ECONOMY**

### Španjolet brava



Tip	Kod
Brava bez reza	F002039

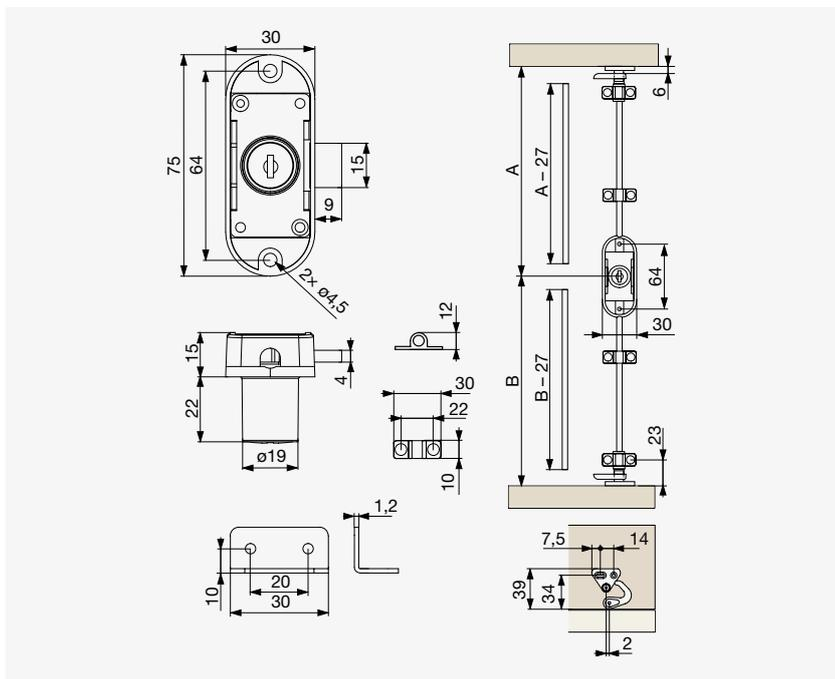

- Uključuje 2 ključa i rozetu
- Opremiti sa dvije cijevi da se dobije kompletan set

## ⊕ Riex EZ20 **ECONOMY**

### Cijev za španjolet bravu

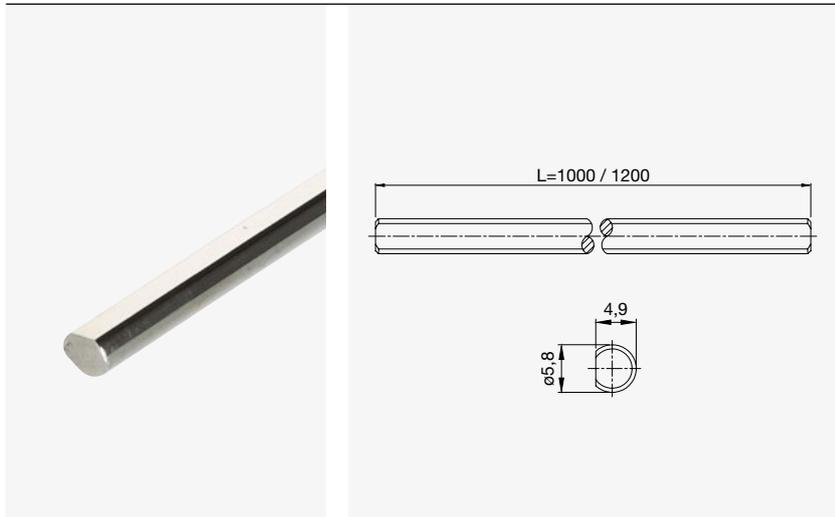

Duljina [mm]	Kod
1000	F002901
1200	F002902

# Vijci, magnetski zasuni i dodaci

## ⊕ Riex EZ05 Zasun za namještaj

07

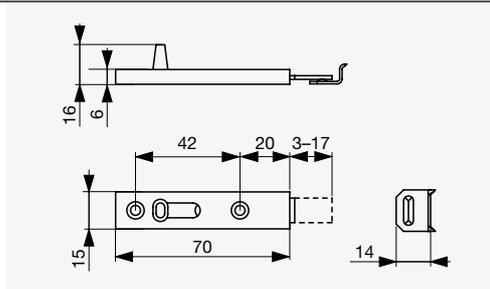

Boja	Kod
Nikal	F003570

## ⊕ Riex EZ20 Profil za bravu

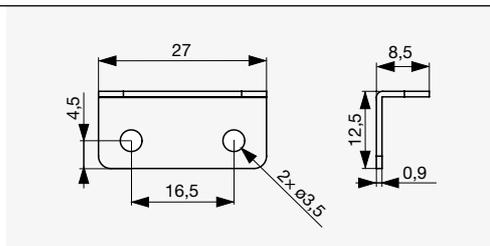

Boja	Kod
Cink	F002043

• Drugi model udarne ploče F002092 – vidi stranicu 7.6

## ⊕ Riex ER15 Zatvarač za dvokrilna vrata

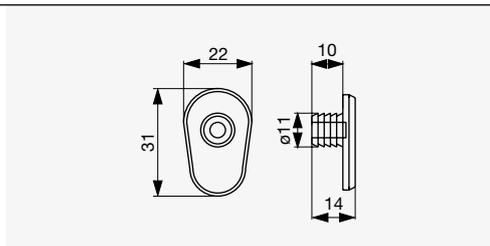

Boja	Kod
Bijela	F002944
Smeđa	F002945
Crna	F002946
Bež	F002947
Siva	F002948

○ Bijela



● Smeđa



● Crna



● Bež



● Siva

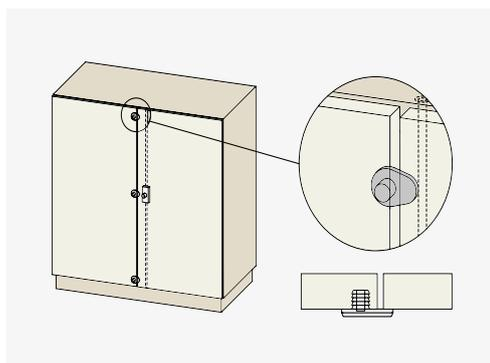

## ⊕ Riex EG20 Magnetski zasun za vrata 4 kg



○ Bijela

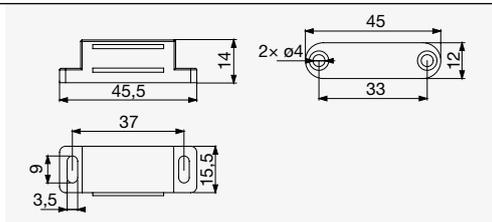

Boja	Kod
Bijela	F002149
Smeđa	F002148

- Sa metalnom udarnom pločom



● Smeđa

## ⊕ Riex EG60 Magnetski zasun za vrata 8 kg



○ Bijela

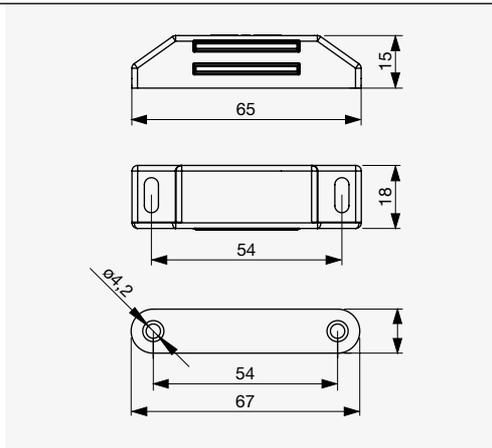

Boja	Kod
Bijela	F003003
Smeđa	F003004

- Sa metalnom udarnom pločom



● Smeđa

## ⊕ Riex EG80 Magnetski zasun za vrata 12 kg



○ Bijela

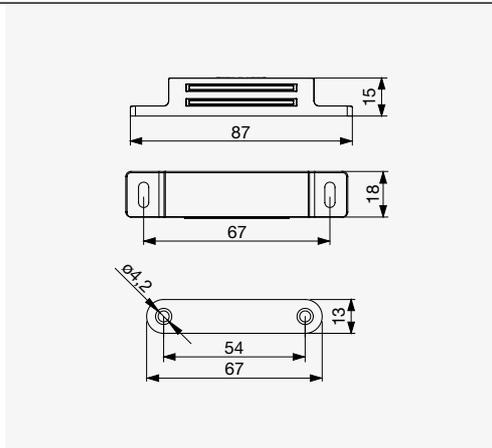

Boja	Kod
Bijela	F003005
Smeđa	F003006

- Sa metalnom udarnom pločom



● Smeđa

# Uredska oprema

Veće kableske uticnice obično su izrađene od visokokvalitetnog aluminija i dostupne su u raznim popularnim bojama. Manje uticnice su najčešće izrađene od cinka, dok su osnovni tipovi, izrađeni od plastike, ponuđeni u više boja. Nastavićemo brisi i dalje značajno siriti naš asortiman, stoga pomno pratite našu online trgovinu.



---

● <b>Utičnice za kabele</b>	<b>8.3</b>
Utičnice za kabele – aluminij	8.4
Utičnice za kabele – lijevani cink	8.6
Utičnice za kabele – plastika	8.7

# Utičnice za kabele

08



## ● ASA Jednostruki kabelski izlaz [Cable Exit Mono] 2.0 Kabelski izlaz od aluminija



○ Bijela



● Crna

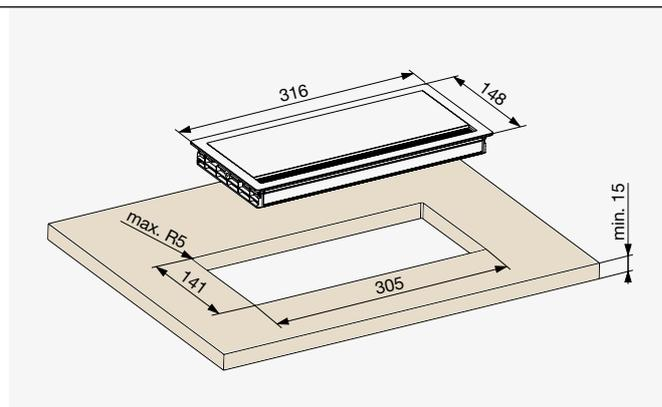

- Gornja ploča je izrađena od čvrstog aluminija
- Mehanizam za lagano zatvaranje

Boja	Kod	Dimenzije [mm]	Visina ugradnje [mm]
Bijela	F005556	316 x 148	25
Crna	F005557		

## ● ASA Dvostruki kabelski izlaz [Cable Exit Dual] Kabelski izlaz od aluminija



● Crna



○ Bijela

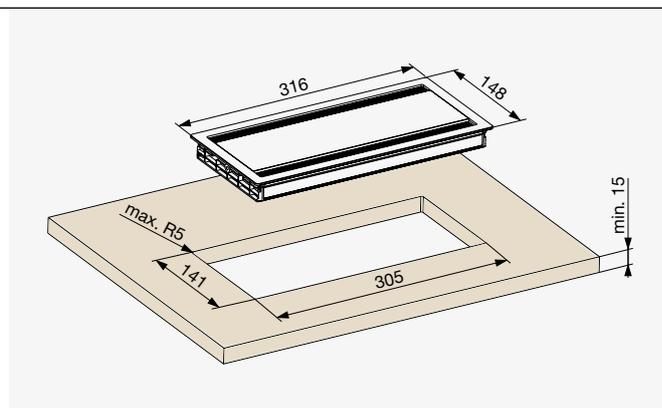

- Gornja ploča je izrađena od čvrstog aluminija
- Obje strane otvora

Boja	Kod	Dimenzije [mm]	Visina ugradnje [mm]
Bijela	F005558	316 x 148	25
Crna	F005559		

**⊕ Riex EK13 Izlazni rub 100 × 100 mm**  
**[Exit Edge 100 × 100 mm] Kabelski izlaz**

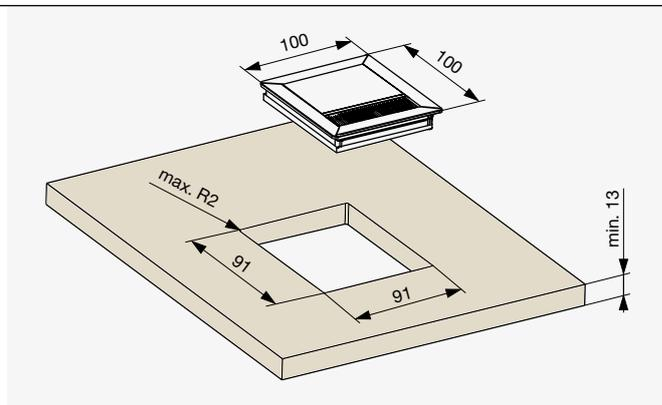

- Profil od aluminija

08

Boja	Kod	Dimenzije [mm]	Visina ugradnje [mm]
Eloksirani aluminij	F005560	100 × 100	13

**⊕ Riex EK13 Izlazni rub 240 × 100 mm**  
**[Exit Edge 240 × 100 mm] Kabelski izlaz**

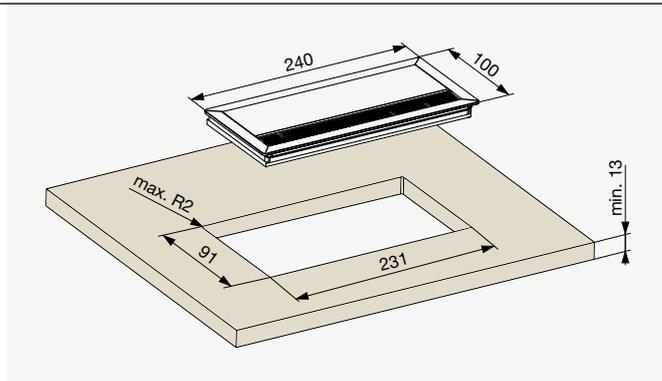

- Profil od aluminija

Boja	Kod	Dimenzije [mm]	Visina ugradnje [mm]
Eloksirani aluminij	F005561	240 × 100	13



## ● ASA Okrugli kabel prečnika 80 mm [Cable Round ø80 mm] Kabelski izlaz od lijevanog cinka



● Krom

Boja	Kod	Visina ugradnje [mm]
Krom	F005562	22
Imitacija nehrđajućeg čelika	F005563	

## ● Riex EK60 ø60 mm Kabelski izlaz od lijevanog cinka

R<sub>I</sub>E<sub>X</sub>

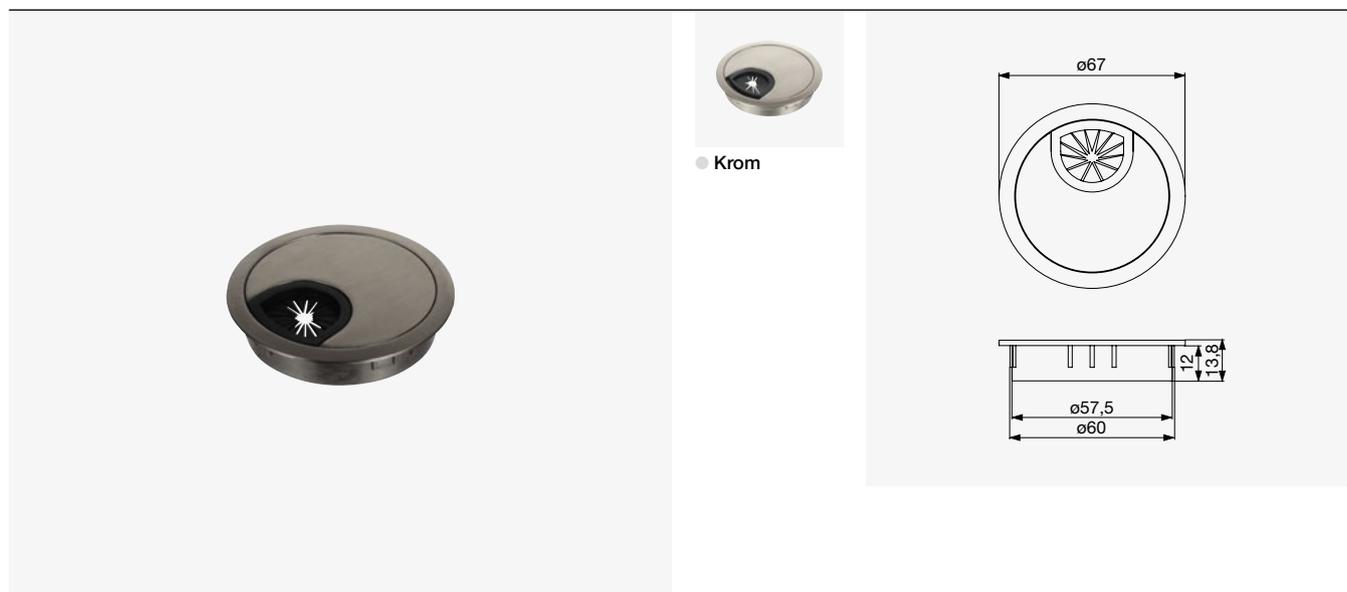

● Brušeni nikel

Boja	Kod	Visina ugradnje [mm]
Brušeni nikel	F003045	12
Krom	F003046	

### ⊕ Riex EK62 ø60 mm Plastični kabelski izlaz

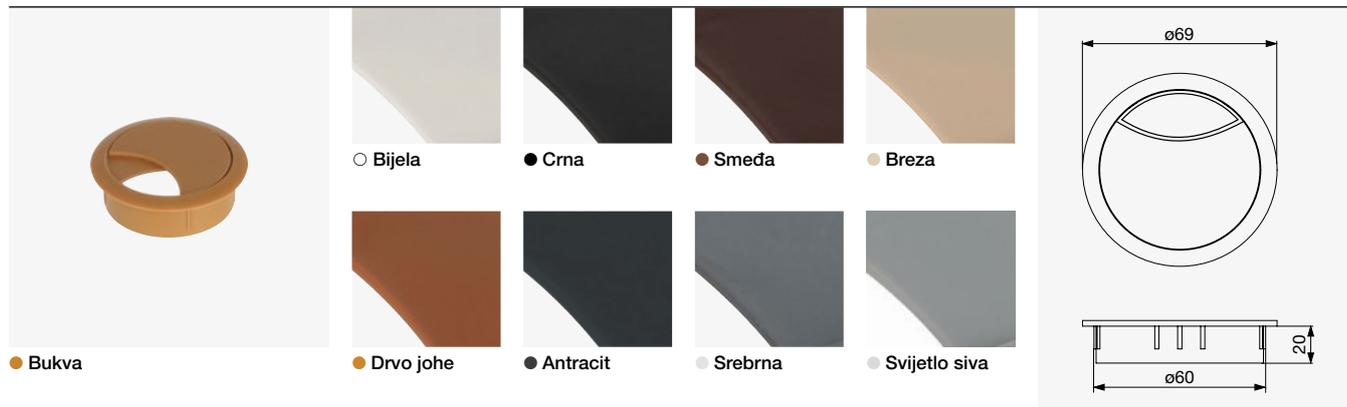

Boja	Kod	Visina ugradnje [mm]
Bijela	F005515	20
Bukva	F005517	
Crna	F005518	
Smeđa	F005519	
Breza	F005521	
Drvo johe	F005522	
Antracit	F005523	
Srebrna	F005524	
Svijetlo siva	F005525	

08

### ⊕ Riex EK72 ø70 mm Plastični kabelski izlaz

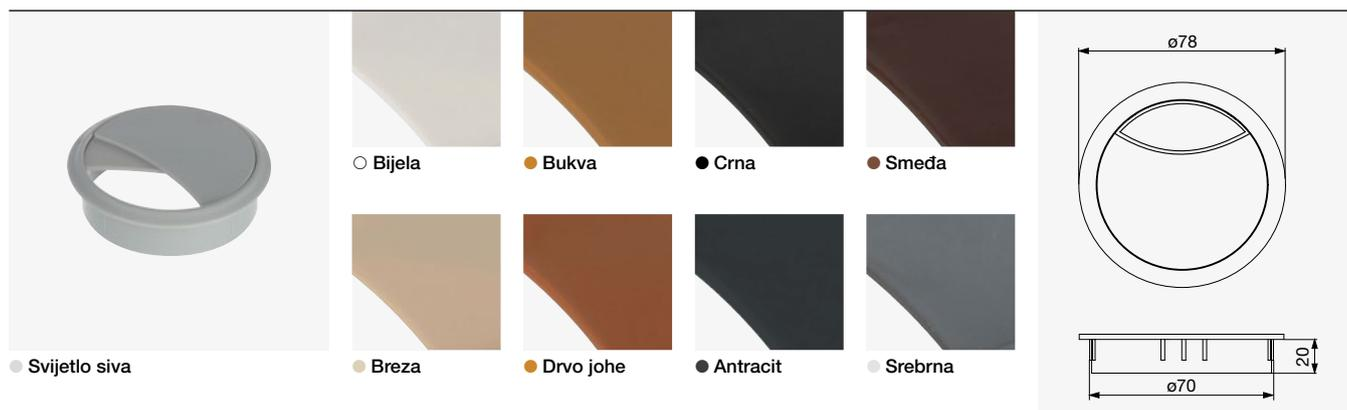

Boja	Kod	Visina ugradnje [mm]
Bijela	F005527	20
Bukva	F005529	
Crna	F005530	
Smeđa	F005531	
Breza	F005533	
Drvo johe	F005534	
Antracit	F005535	
Srebrna	F005536	
Svijetlo siva	F005537	

## ⊕ Riex EK64 ø60 mm Plastični kabelski izlaz

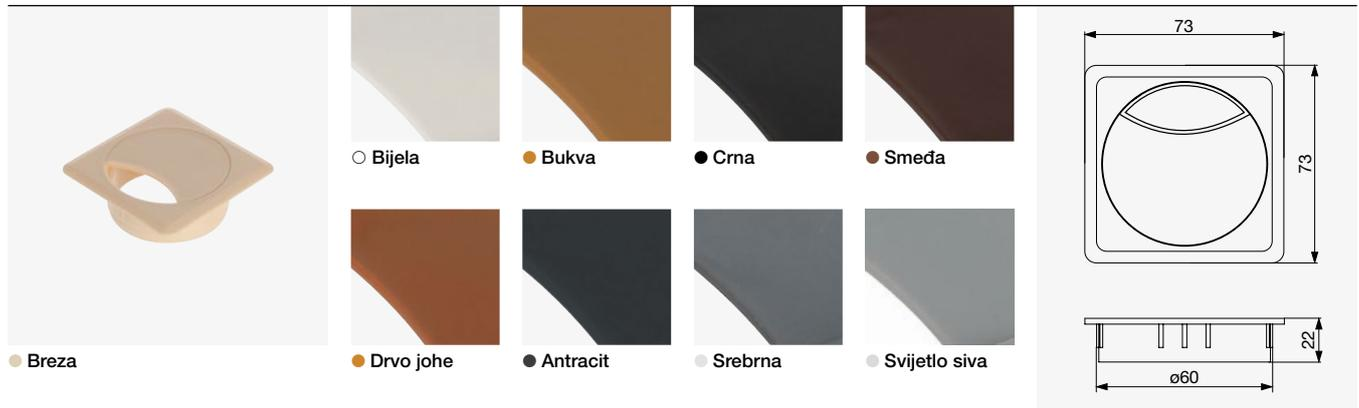

Boja	Kod	Visina ugradnje [mm]
Bijela	F005539	20
Bukva	F005541	
Crna	F005542	
Smeda	F005543	
Breza	F005545	
Drvo johe	F005546	
Antracit	F005547	
Srebrna	F005548	
Svijetlo siva	F005549	

# Kuhinjska oprema

U poglavlju kuhinjske opreme pronaći ćete cijeli niz dodataka bez kojih kuhinja ne bi bila cjelovita. Na primjer, tu su plastične posude za odlaganje pribora za jelo, neklizajuće podloge za ladice i podloge ispod sudopera za zaštitu od kapanja vode. Drugi asortiman uključuje ventilacijske rešetke i ventilacijske kanale za pravilnu cirkulaciju zraka oko uređaja. Asortiman opreme za radne ploče uključuje profile za završavanje i spajanje radnih ploča ili konzole za barove za izradu stepenastih šankova.



---

● Riex Posude za odlaganje pribora za jelo	9.3
● Neklizajuće podloge	9.10
● Ventilacijske rešetke i kanali	9.13
● Dodatni elementi za radne ploče	9.15

---

01  
02  
03  
04  
05  
06  
07  
08  
09  
10  
11  
12  
13  
14  
15  
16  
17  
18

# Riex Posude za odlaganje pribora za jelo

- Jednostavno umetanje u ladicu
- Nekoliko boja i površina
- Lako se uklapa u određenu dimenziju
- Više dodataka i umetaka

09



## ⊕ Riex GM70 Posude za odlaganje pribora za jelo



- Klasičan oblik
- Dvostruka struktura dizajna
- Protuklizna površina mekana na dodir za dizajnerske modele
- Visina 50 mm
- Spreman za RiexTrack 500 ili 450 mm dubine
- Jednostavno smanjivanje veličine

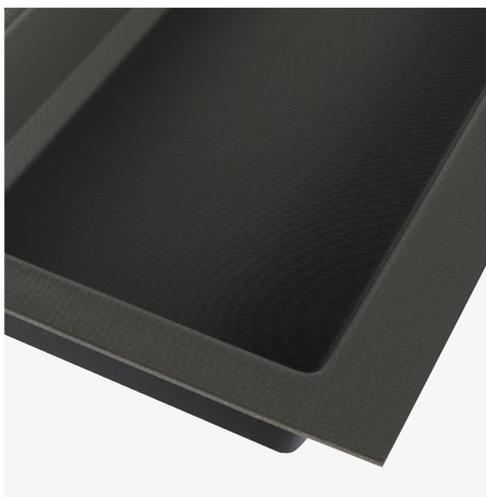

### Za ormariće dubine 500 mm

Širina ormarića [mm]	Mekano na dodir, siva	Zrnasta struktura, bijela	Dimenzije proizvoda		
			Širina [mm]	Dubina [mm]	Visina [mm]
300	F003469	F003587	222		
400	F003470	F003583	322		
450	F003471	F003584	372		
500	F003472	F003582	422		
600	F003473	F003479	522		
700	F003474	F003480	622	474	50
800	F003475	F003481	722		
900	F003476	F003482	822		
1000	F003477	×	922		
1200	F003478	×	1122		

Maksimalno smanjenje veličine: širina = do 42 mm, dubina = do 29 mm.

### Za ormariće dubine 450 mm

Širina ormarića [mm]	Glatko na dodir, siva	Zrnasta struktura, bijela	Dimenzije proizvoda		
			Širina [mm]	Dubina [mm]	Visina [mm]
600 / 522	F003483	F003484	522	424	50



09

**➤ Riex GM70 Dodatna oprema**

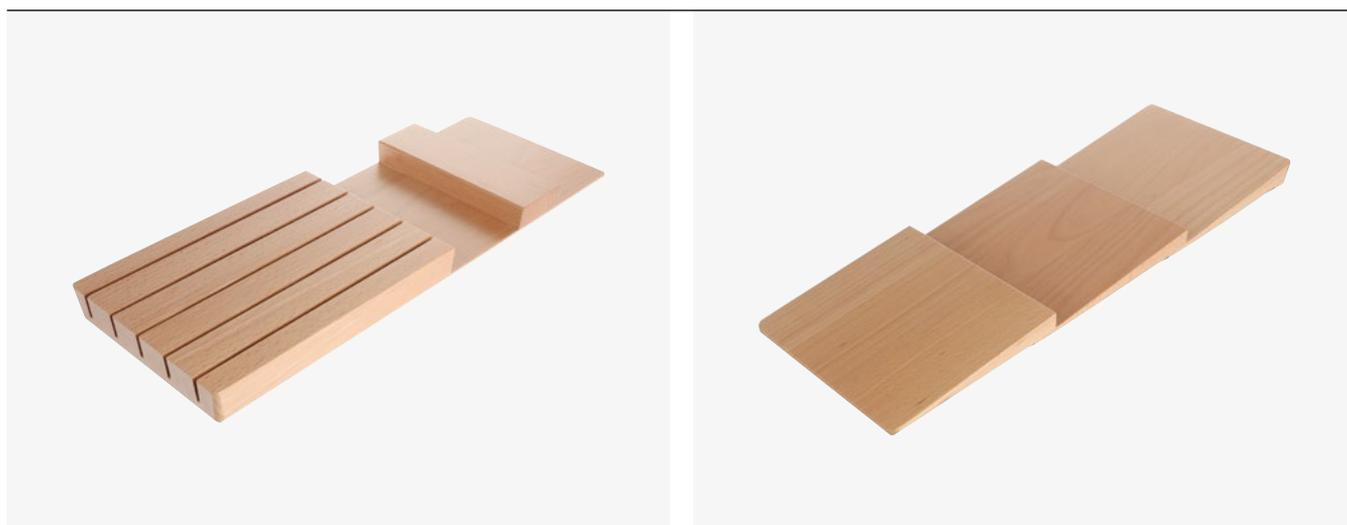

Tip	Kod	Materijal	Dimenzije [mm]	Umetak za
Držac za noževe	F003557	Hrast	110 × 414	600, 700, 800, 900, 1000, 1200 [2×]
Umetak za začine	F003558		155 × 422	



## ⊕ Riex GM60 Posude za odlaganje pribora za jelo



- Okrugli oblik
- Poseban dizajn površine – Globe softTouch
- Visina 48 mm
- Za ormarić dubine 500 mm
- Jednostavno smanjivanje veličine

Širina ormarića [mm]	Globe SoftTouch Crna boja [glatko na dodir]	Dimenzije proizvoda		
		Širina [mm]	Dubina [mm]	Visina [mm]
300	F003459	222		
400	F003460	322		
450	F003461	372		
500	F003462	422		
600	F003463	522	474	48
700	F003464	622		
800	F003465	722		
900	F003466	822		

Maksimalno smanjenje veličine: širina = do 22 mm, dubina = do 24 mm.

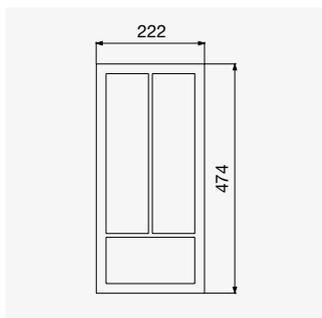

⊕ 300 / 500

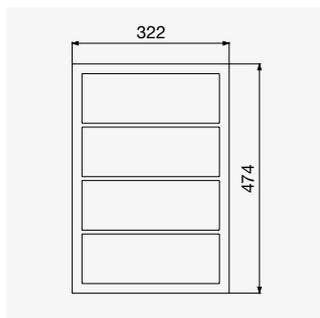

⊕ 400 / 500

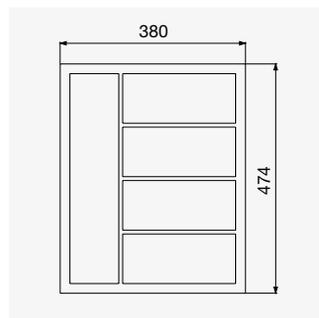

⊕ 450 / 500

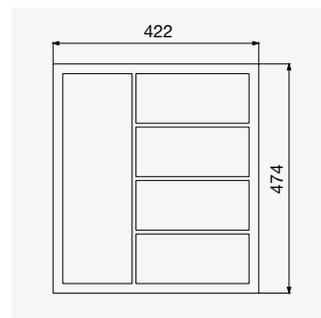

⊕ 500 / 500

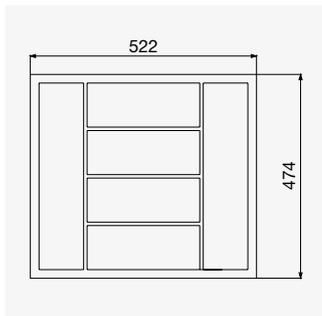

⊕ 600 / 500

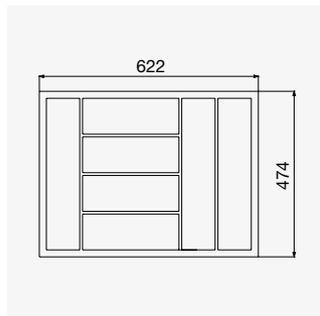

⊕ 700 / 500

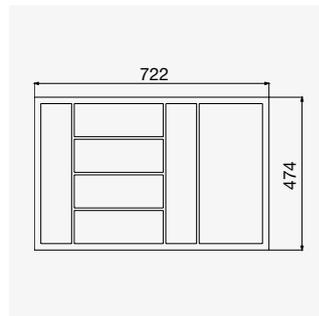

⊕ 800 / 500

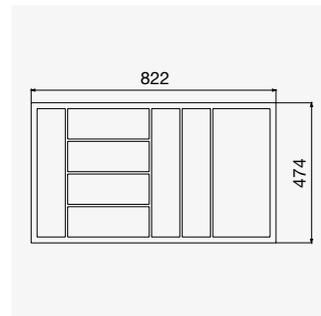

⊕ 900 / 500

## 09 Riex GM60 Dodatna oprema

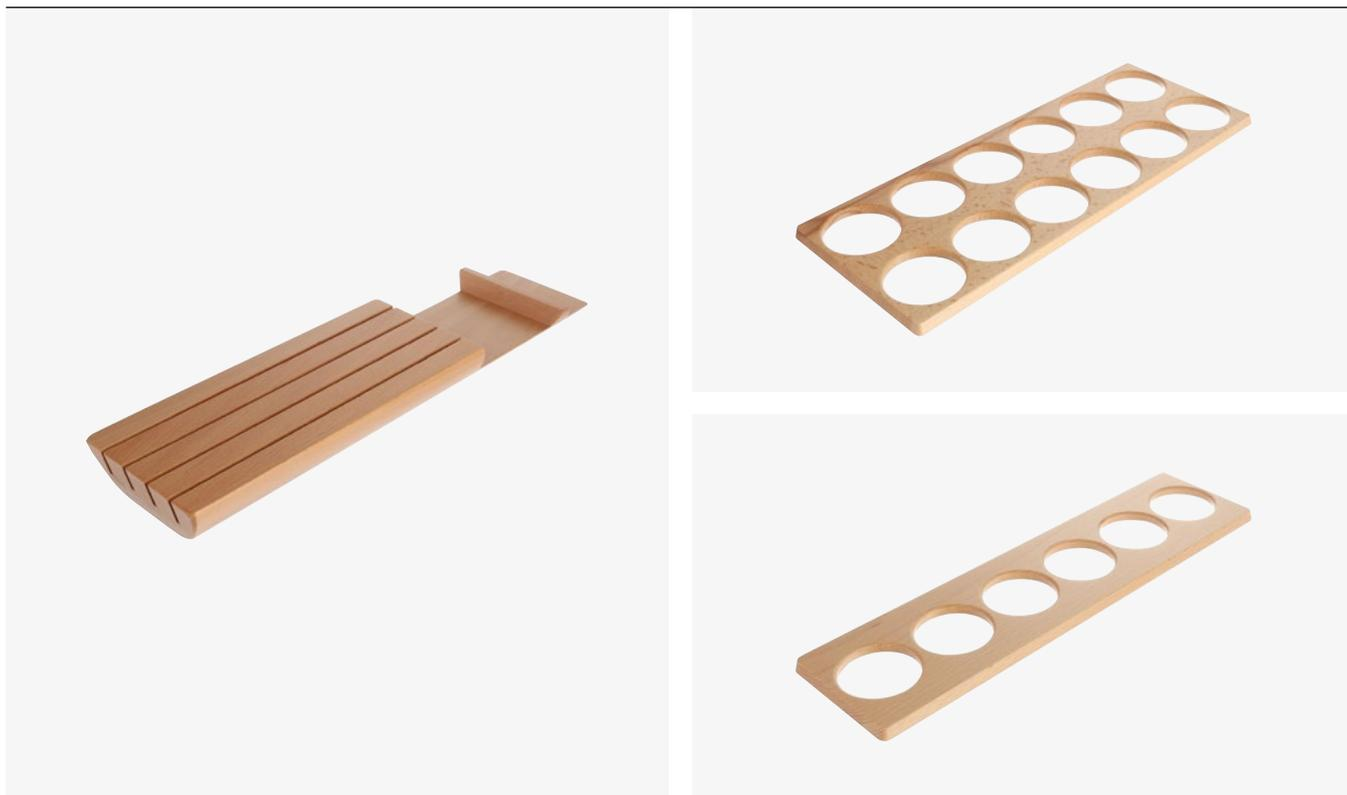

Tip	Kod	Materijal	Dimenzije [mm]	Umetak za
Držač za noževe	F003491	Bukva	110 × 414	800, 900
Umetak za začine – za 12 komada	F003495		165 × 417	800, 900
Umetak za začine – za 6 komada	F003492		111 × 417	450, 500, 600 [2×], 700 [3×], 800 [2×], 900 [3×]

## ⊕ Riex GM50 Posude za odlaganje pribora za jelo



- Klasičan dizajn
- Glatka površina
- Za ormarić dubine 500 mm
- Jednostavno smanjivanje veličine



Širina ormarića [mm]	Srebrna	Bijela	Dimenzije proizvoda		
			Širina [mm]	Dubina [mm]	Visina [mm]
300	F003443	F003434	235	490	50
400	F003444	F003435	335		
450	F003445	F003436	385		
500	F003446	F003437	435		
600	F003447	F003438	535		
700	F003448	F003439	635		
800	F003449	F003440	735		
900	F003450	F003441	835		

Maksimalno smanjenje veličine: širina = do 25 mm, dubina = do 40 mm.

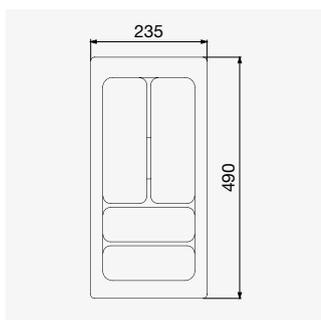

① 300 / 500

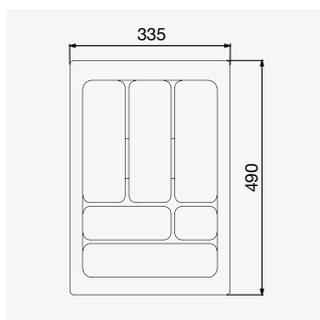

① 400 / 500

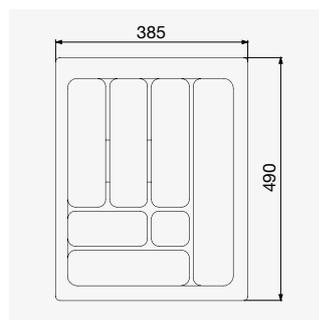

① 450 / 500

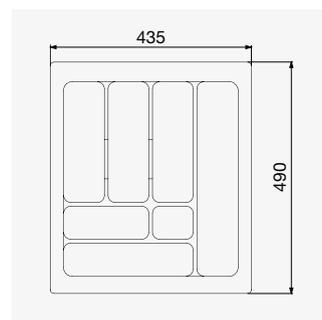

① 500 / 500

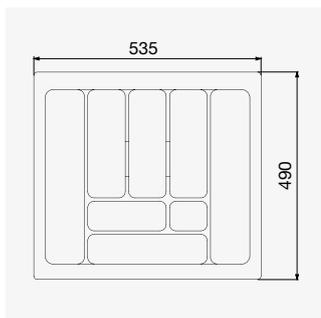

① 600 / 500

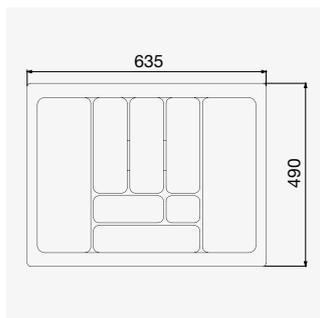

① 700 / 500

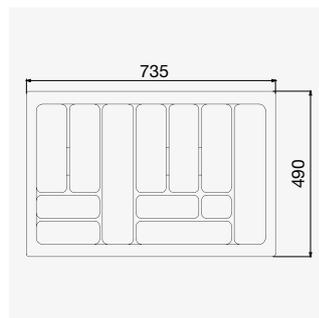

① 800 / 500

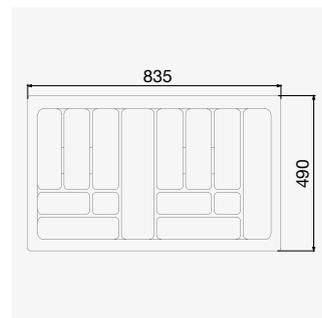

① 900 / 500

## ⊕ Riex GM45 Posude za odlaganje pribora za jelo [za dubinu 450]



- Klasičan dizajn
- Glatka površina
- Za ormarić dubine 500 mm
- Jednostavno smanjivanje veličine

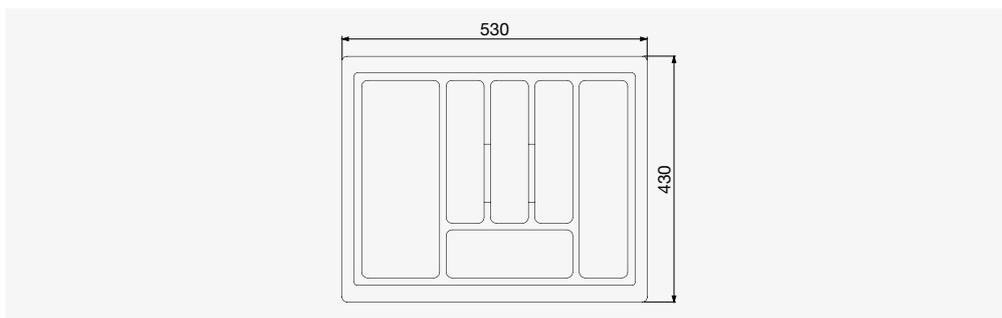

Širina ormarića [mm]	Srebrna	Bijela	Dimenzije proizvoda		
			Širina [mm]	Dubina [mm]	Visina [mm]
600	F003451	F003455	530	430	50
900	F003452	F003456	830		

Maksimalno smanjenje veličine: širina = do 20 mm, dubina = do 20 mm.

## ⊕ Riex GM51 Uložak za ladice za tanjure



- Jednostavno umetanje u ladicu širine 800 mm
- Jednostavno smanjivanje veličine

Širina ormarića [mm]	Srebrna	Bijela	Dimenzije proizvoda		
			Širina [mm]	Dubina [mm]	Visina [mm]
800	F003458	F003457	735	490	50

# Neklizajuće podloge

- Jednostavno umetanje u ladicu
- Nekoliko boja i površina
- Lako se uklapa u određenu dimenziju
- Moguće koristiti i za police i za kuhinjske sustave za odlaganje

## ⊕ Riex GM80 Neklizajuća podloga za tvrdi stol



⊙ Globus crna

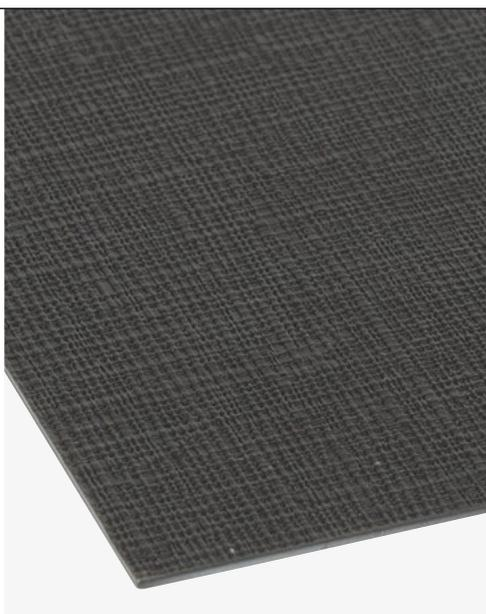

⊙ Platno siva

- Rezanje prema dimenzijama ladice
- Dva dizajna površine
- Stolni format debljine 1 mm
- Nije neophodno koristiti ljepljivo
- Unaprijed izrezan za korištenje s RiexTrack

Širina ormarića [mm]	Globus crna	Platno siva	Dimenzije proizvoda		
			Širina [mm]	Dubina [mm]	Debljina [mm]
600	F003467	F003485	522	474	1
700	F003468	F003486	622		
800	F003581	F003487	722		
900	F003560	F003488	822		

## 0 Riex GM82 Neklizajuća podloga u roli

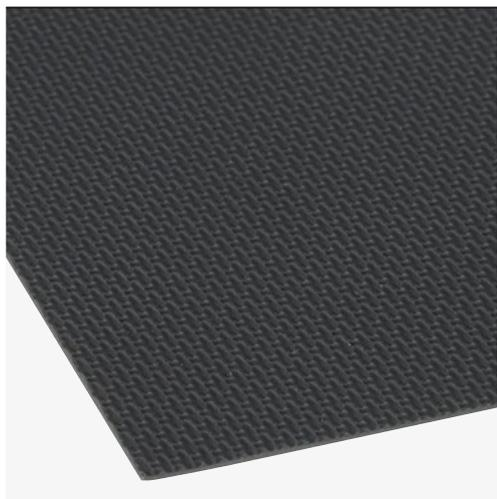

● Antracit



○ Bijela

- Idealno za nestandardno rezanje
- Debljina 1,2 mm
- Čvrsti SoftGrip dizajn

Širina [mm]	Boja	Kod	Duljina [m]	Debljina [mm]
600	Antracit	F003490	10	1,2
	Bijela	F003494		

09

## 0 Riex GM85 Neklizajuća podloga u roli sa zaštitom od vode

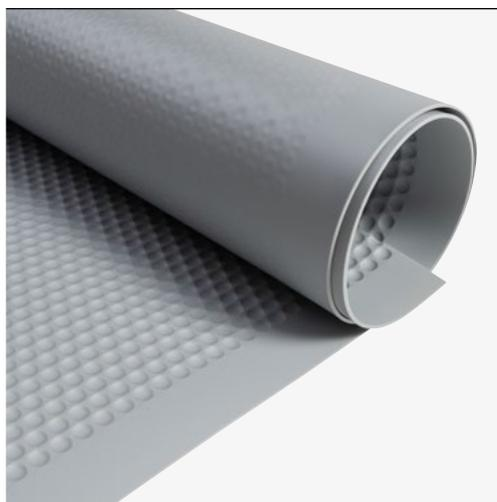

● Silver

Širina [mm]	Boja	Kod	Duljina [m]	Debljina [mm]
600	Srebrna	F003559	1200	1,2

● IF Neklizajuća podloga u roli

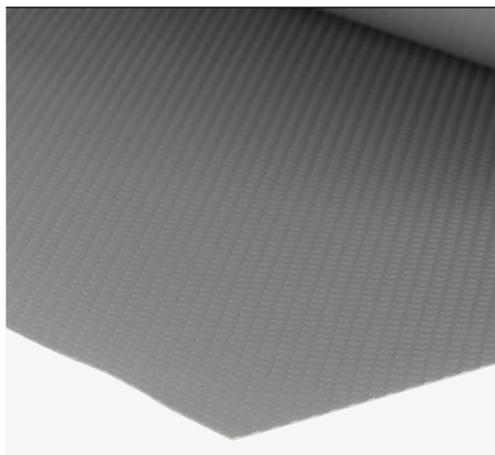

● Svijetlo siva



● Antracit

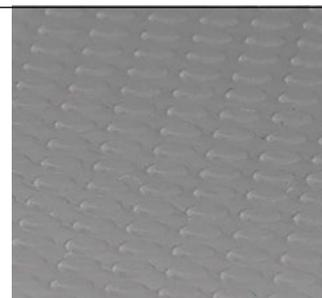

● Svijetlo siva – detalj

Površina sa izbočinama

Širina [mm]	Boja	Kod	Duljina [m]	Debljina [mm]
480	Svijetlo siva	F002736	20	1,2
	Antracit	F002737		

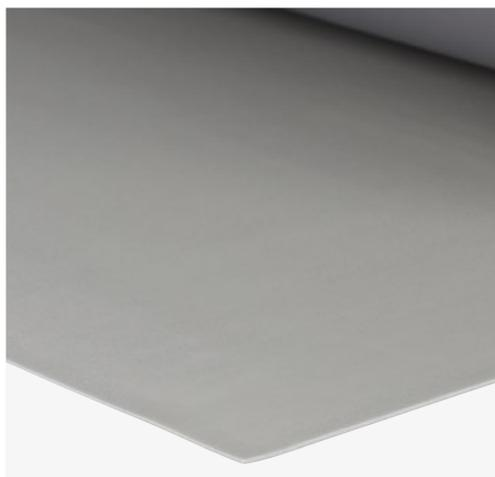

● Svijetlo siva



● Antracit

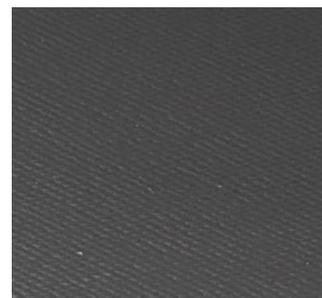

● Antracit – detalj

Valoviti dizajn

Širina [mm]	Boja	Kod	Duljina [m]	Debljina [mm]
480	Svijetlo siva	F002738	20	1,2
	Antracit	F002739		

01  
02  
03  
04  
05  
06  
07  
08  
09  
10  
11  
12  
13  
14  
15  
16  
17  
18

# Ventilacijske rešetke i kanali

## ● Riex GV44 Aluminijska ventilacijska rešetka

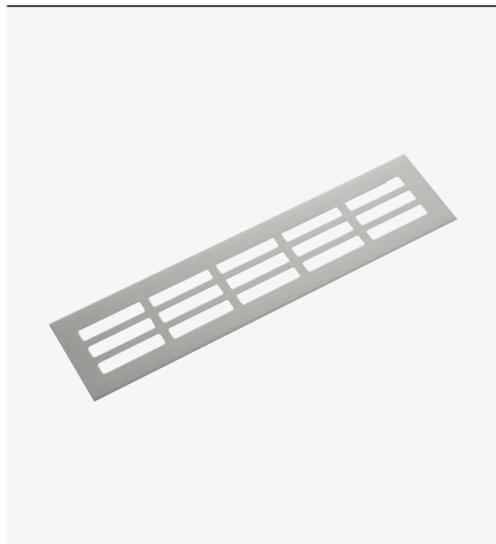

● Imitacija Nehrđajućeg čelika ○ Bijela ● Mat crna

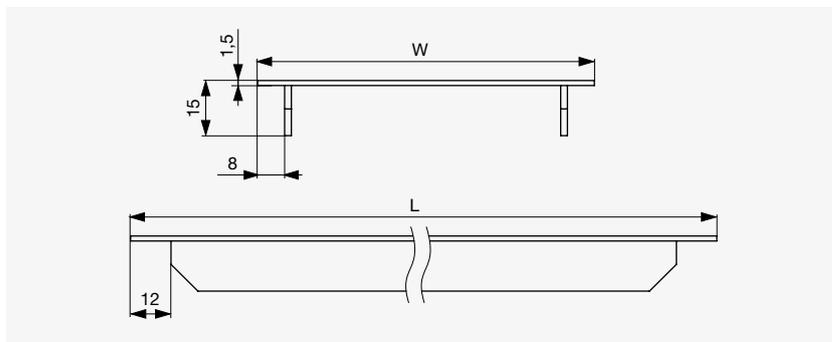

● Eloksirani aluminij

Širina W [mm]	Duljina L [mm]	Eloksirani aluminij	Imitacija nehrđajućeg čelika	Bijela	Mat crna
60	250	F000951	F000974	F000997	F007363
	400	F000952	F000975	F000998	F007364
	500	F000953	F000976	F000999	F007365
	600	F000954	F000977	F001000	F007366
	800	F000955	F000978	F001001	F007367
	1000	F000956	F000979	F001002	F007368
80	250	F000957	F000980	F001003	F007369
	400	F000958	F000981	F001004	F007370
	500	F000959	F000982	F001005	F007371
	600	F000960	F000983	F001006	F007372
	800	F000961	F000984	F001007	F007373
	1000	F000962	F000985	F001008	F007374
100	250	F000963	F000986	F001009	F007375
	400	F000964	F000987	F001010	F007376
	500	F000965	F000988	F001011	F007377
	600	F000966	F000989	F001012	F007378
	800	F000967	F000990	F001013	F007379
	1000	F000968	F000991	F001014	F007380
150	400	F000969	F000992	F001015	F007381
	500	F000970	F000993	F001016	F007382
	600	F000971	F000994	F001017	F007383
	800	F000972	F000995	F001018	F007384
	1000	F000973	F000996	F001019	F007385



## ⊕ Riex GV23 Ventilacijski kanal, prečnik 35 mm



○ Bijela



● Crna

● Siva

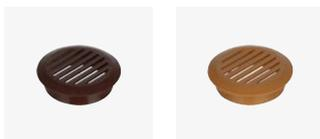

● Smeđa

● Bukva

Boja	Kod
Bijela	F001020
Crna	F001021
Siva	F001022
Smeđa	F001023
Bukva	F001024

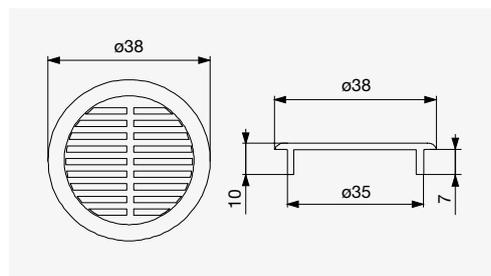

## ⊕ Riex GV25 Ventilacijski kanal, prečnik 50 mm



○ Bijela



● Crna

● Siva



● Smeđa

● Bukva

Boja	Kod
Bijela	F001025
Crna	F001026
Siva	F001027
Smeđa	F001028
Bukva	F001029

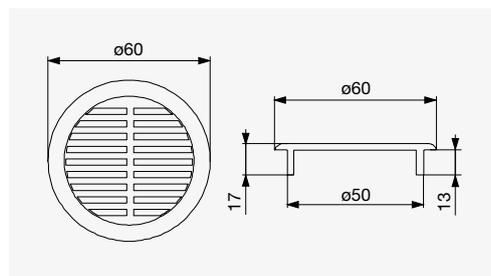

# Dodatni elementi za radne ploče

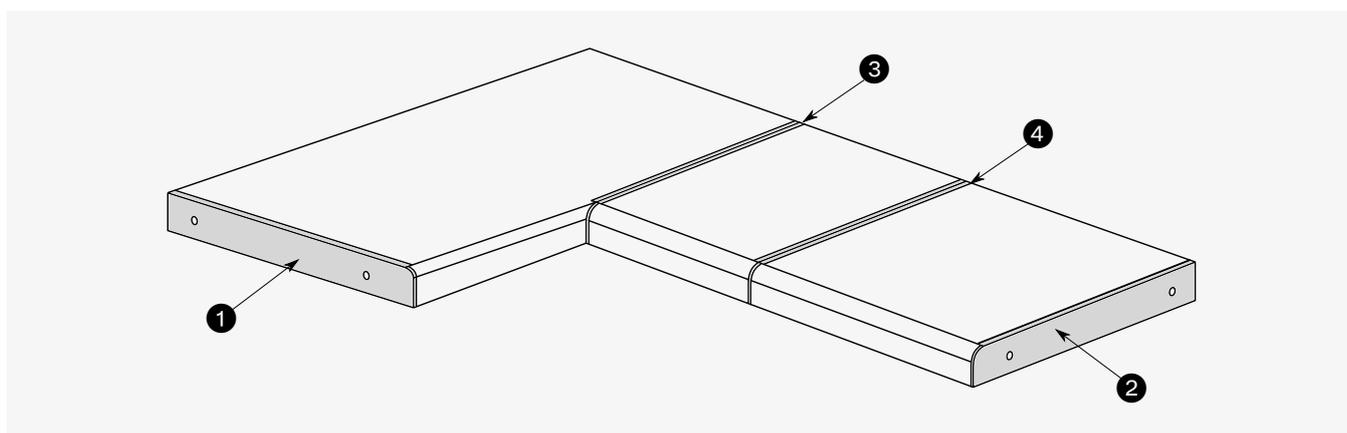

09

## ➊ Riex GI37 Profil za radnu ploču, prečnik 3 mm, eloksirani aluminij

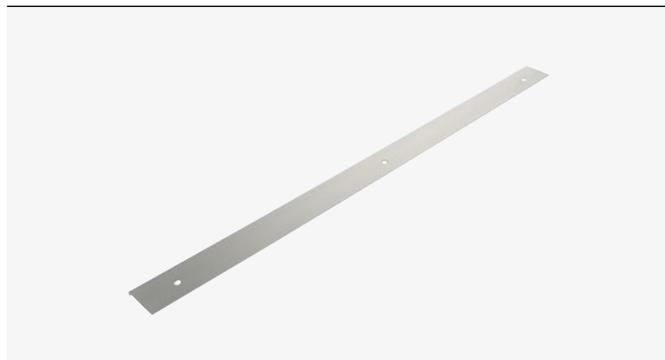

● F001201



● F001202



● F001203



● F001204

	Primjena	Strana	Kod	Visina [mm]	Duljina [mm]
➊	Završni profil	Levo	F001201	38	600
➋	Završni profil	Desno	F001202		
➌	Kutni spojni profil	Levo / desno	F001203		
➍	Spojni profil	Levo / desno	F001204		

## ⊕ Riex GI35 Profil za radnu ploču, prečnik 0 mm, eloksirani aluminij



⊕ F001205



⊕ F001206



⊕ F001207

	Primjena	Strana	Kod	Visina [mm]	Duljina [mm]
①	Završni profil	Lijevo	F001205		
②	Završni profil	Desna	F001206	38	600
③	Kutni spojni profil	Lijevo / desno	F001207		

## ⊕ Riex GI22 Barska konzola, nehrđajući čelik



⊕ F001198



⊕ F001199

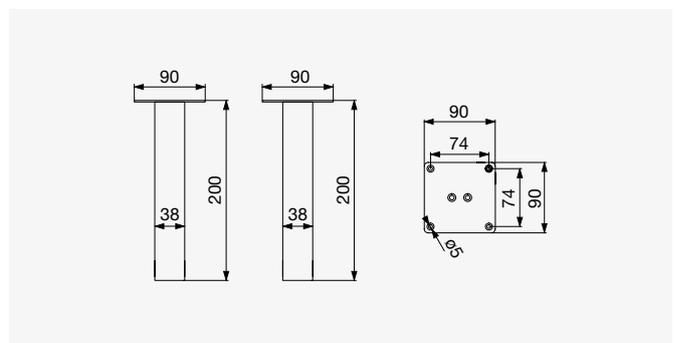
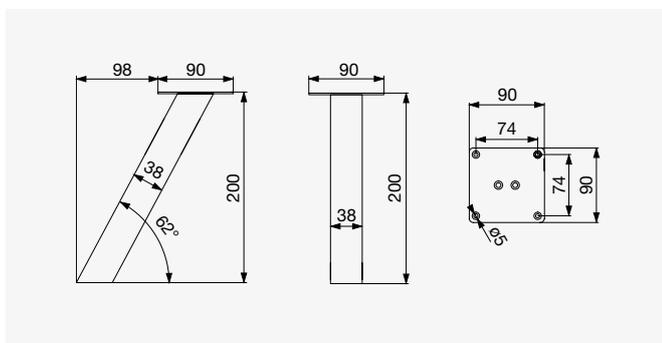

Nagib	Kod
Nagnuto	F001198
Uspravno	F001199

# Kuhinjski sustavi za pohranu

Kuhinjski sustavi za pohranu jedno su od najopsežnijih poglavlja opremanja namještaja, jer obuhvaćaju opremu za sve vrste kuhinjskih elemenata. Ovdje ćete pronaći okove za ormare za pohranu hrane, izvlačne i okretne police za donje ormare, te mehanizme za iskorištenje prostora u kutnim ormarima. Za gornje kuhinjske elemente nudimo stalak za ocjeđivanje od nehrđajućeg čelika. Iskorištavanje prostora između gornjih i donjih ormara može biti izazov, ali možete koristiti naš genijalni sustav vješanja. Nudimo opremu za kuhinjske elemente pod markom RIEX ili također poznatih proizvođača kao što je Kesseböhmer.



● <b>Izvlačne košare – velike</b>	<b>10.3</b>
Kesseböhmer CONVOY Lavidio	10.4
Kesseböhmer CONVOY Premio	10.6
Kesseböhmer TANDEM II	10.9
Kesseböhmer TANDEM side	10.11
Kesseböhmer DISPENSA	10.13
Riex GX53 / GX58	10.17
● <b>Izvlačne košare – kutne</b>	<b>10.19</b>
Kesseböhmer LeMans II	10.20
Kesseböhmer MagicCorner	10.22
Kesseböhmer Revo 90°	10.24
Kesseböhmer Carousel 270°	10.25
Riex GP68 Izvlačne kutne košare	10.26
Riex GP58 Izvlačne kutne košare	10.27
Riex GP63 Izvlačne kutne košare	10.28
Riex GP28 Carousel	10.29
Riex GP13 Carousel	10.30
● <b>Izvlačne košare – male</b>	<b>10.31</b>
Kesseböhmer br. 15	10.32
Kesseböhmer COMFORT II	10.34
Kesseböhmer DISPENSA junior III	10.36
Kesseböhmer DISPENSA junior slim	10.39
Kesseböhmer cleaningAGENT	10.42
Riex Bočne košare bez okvira	10.43
Riex Bočne košare sa okvirom	10.45
Riex Donje košare	10.46
● <b>Kuhinjski dodaci</b>	<b>10.47</b>
Kesseböhmer iMove	10.48
Kesseböhmer TurnMotion II	10.49
Riex Ocjeđivači posuđa	10.50
● <b>Organizatori</b>	<b>10.51</b>
Kesseböhmer SpaceFlexx	10.52
Riex GI88 Sustav za vješanje	10.53

# Izvlačne košare – velike

10



# Kesseböhmer CONVOY Lavido

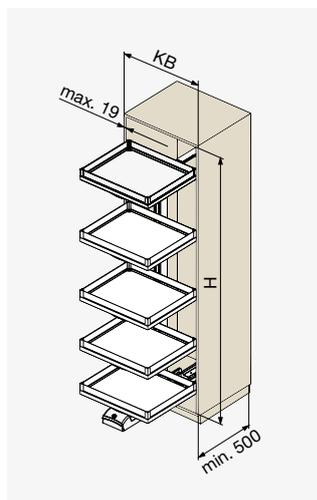

- Izvlačne košare – velike bez priključena vrata

**Za cijeli set je potrebno naručiti:**

- Okvir
- Vodilicu
- Košare s dodatcima

**Opcijski dodaci:**

- eTouch za električno otvaranje i zatvaranje

## ● CONVOY Lavido okvir



● Antracit

● Srebrno

Visina ormarića H [mm]	Antracit	Srebrno	Visina [mm]	Dubina ormarića [mm]
1800–1899	F005171	F005170	1430	min. 500
1900–1999	F005173	F005172	1530	
2000–2099	F005175	F005174	1630	

## ● CONVOY Lavido vodilica

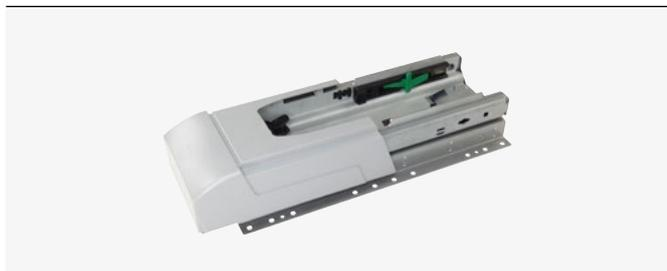

- Potpuni prikaz proširenja s integriranim damping-a za zatvaranje i otvaranje
- Nosivost kapaciteta 130 kg

Antracit	Sivo
F005204	F005205

01  
02  
03  
04  
05  
06  
07  
08  
09  
10  
11  
12  
13  
14  
15  
16  
17  
18

## ● CONVOY Lavidó

### Skup košara s dodacima



① F005207



① F005206

#### Sadržaj seta:

- 1 ladica sa integriranim „top runner-om“
- 4 ladice, podešavanje po visini
- 5 kutija za pribor
- 1 armaturni nosač
- 1 fiksni steznik
- 1 ručkica

Širina ormarića KB [mm]	Antracit	Bijelo / Krom	Broj košara	Širina [mm]	Dubina [mm]
500	F005207	F005206	5	450	470
600	F005209	F005208	5	550	

## ● CONVOY Lavidó

### Zamjenske Košare

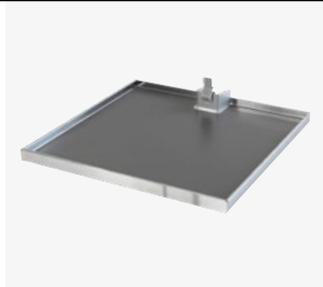

- Paket zamjenskih košarica sadrži sve dodatke košare, uključujući bočne stranice

Širina ormarića [mm]	Antracit	Bijela / Krom
500	F005211	F005210
600	F005213	F005212

Pakiran za 1 košaru.

## ● CONVOY Lavidó

### eTouch Električno otvaranje / zatvaranje



- Opcijski dodaci
- Električni motor izbacuje košare stiskom dugmeta na dršci
- Potpuno otvaranje i potpuno zatvaranje
- Set sadrži motor s EU-DIN utikačem i hvatišta

Otvaranje vrata	Siva
Puni	F005214



# Kesseböhmer CONVOY Premio

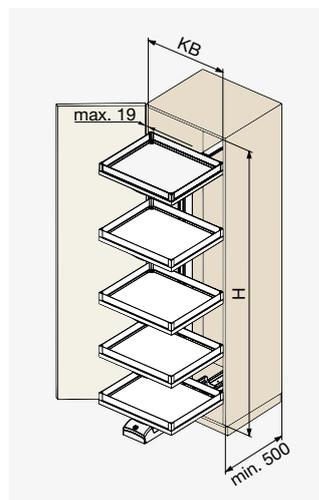

- Prikjučena jedinica s pripojenim vratima

**Za sastavni sklop je potrebno naručiti:**

- Okvir
- Klizač
- Košare s dodatcima

**Opcijski dodaci:**

- eTouch za električno otvaranje i zatvaranje

## ● CONVOY Premio okvir



● Antracit

● Srebrno

Visina ormarića H [mm]	Antracit	Srebrno	Visina [mm]	Dubina ormarića [mm]
1800-1899	F005171	F005170	1430	min. 500
1900-1999	F005173	F005172	1530	
2000-2099	F005175	F005174	1630	

## ● CONVOY Premio vodilica



- Potpuni prikaz proširenja s integriranim damping-a za zatvaranje i otvaranje
- Nosivost kapaciteta 130 kg

Antracit	Sivo
F005215	F005216

01  
02  
03  
04  
05  
06  
07  
08  
09  
10  
11  
12  
13  
14  
15  
16  
17  
18

## ● CONVOY Premio

### Skup košarica s dodacima



① F005218



① F005217

#### Sadržaj paketa:

- 1 pretinac s integriranom gornjoj trkač i upravljačem
- 4 pladja, visina-podešljiva
- 5 kutija za pribor
- 1 držkačica za podršku
- 1 priprema za popravljanje
- 2 konektora na prednjem panelu
- 1 kontrolna poluga dna

Širina ormarića KB [mm]	Smjer otvaranja vrata	Antracit	Bijelo / krom	Broj košara	Širina [mm]	Dubina [mm]
600	Desno	F005218	F005217	5	550	470
	Lijevo	F005220	F005219			

## ● CONVOY Premio

### Zamjenske košare

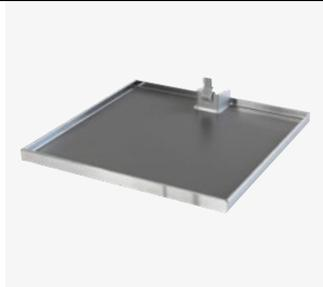

- Paket zamjenskih košarica sadrži sve dodatke košare, uključujući bočne stranice

Širina ormarića [mm]	Antracit	Bijela / Krom
600	F005222	F005221

Pakiranje za 1 košaru.

## ● CONVOY Premio

### eTouch Električno Otvaranje / Zatvaranje



① F005342



① F005176

- Opcijski dodaci
- Električni motor izbacuje košaru pritiskom dugma na dršci na ulazu u vrata
- Djelomično otvaranje znači da su vrata otvorena za 44 mm
- Set sadrži motor s EU-DIN utikačem, prednji senzor i adapter za prednju senzornu jedinicu

Otvaranje vrata	Siva
Potpuni	F005342
Djelomični	F005176

● CONVOY Premio  
Pribor



Ⓢ F005177



Ⓢ F005178

- Koristi se za push to open otvaranje vrata

Tip	Specifikacija	Sivo
Push-to-open za bušenje	22–34 N	F005177
Push-to-open adapter	Za vanjsku instalaciju	F005178



# Kesseböhmer TANDEM II

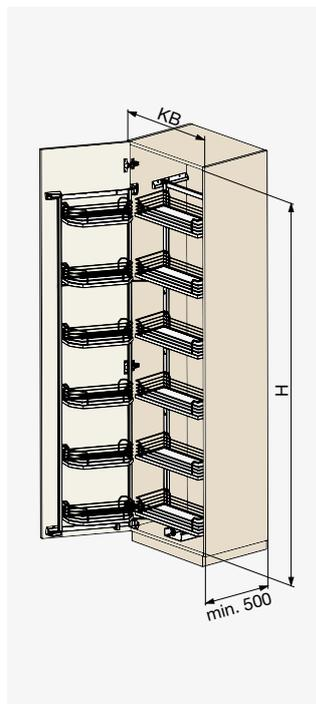

- Upotrebljivo samo u kombinaciji s TANDEM stranom
- Potpuno modularni sustav
- Sve košare se mogu podešavati po visini
- Nosivost kapaciteta 10 kg po košarici

10

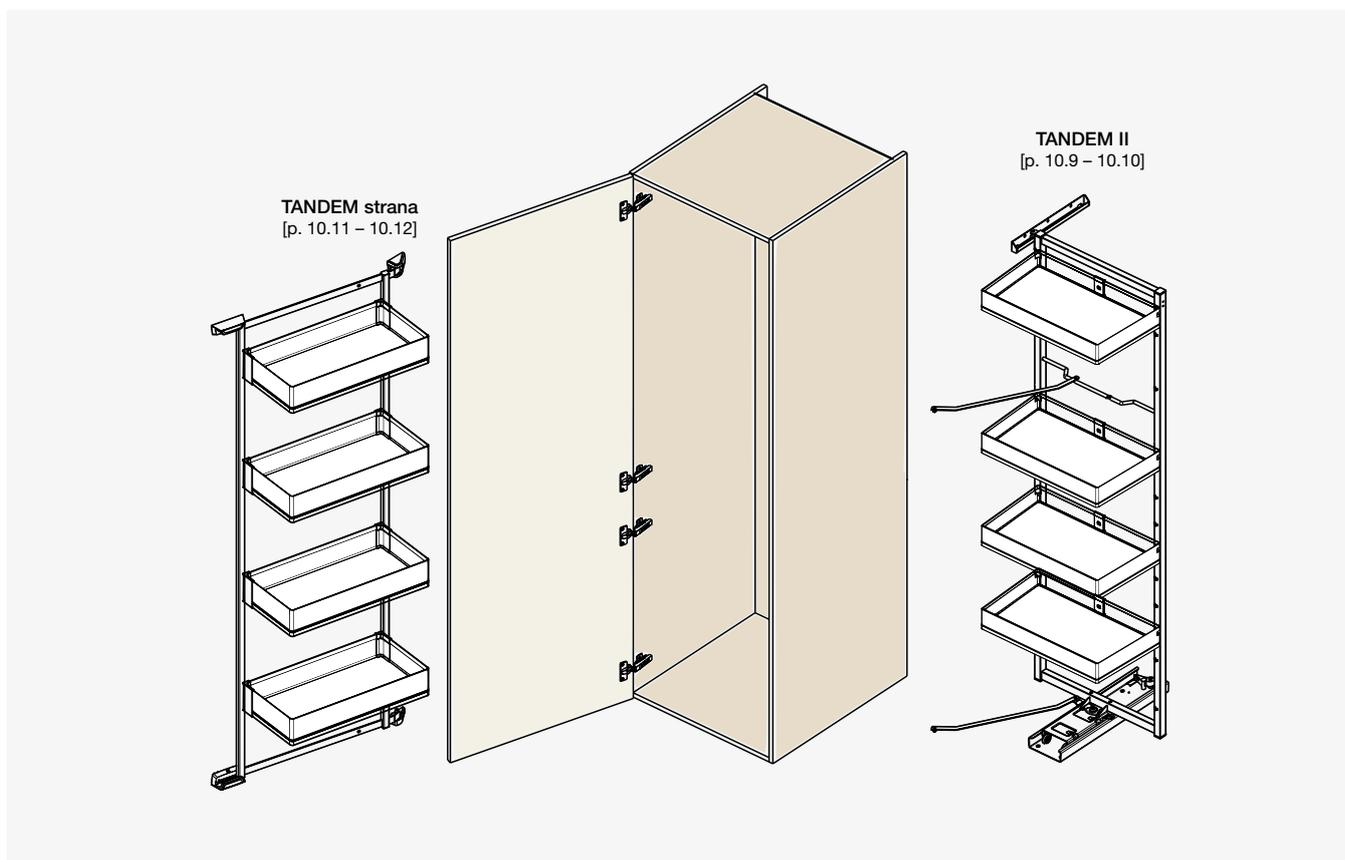

## ● TANDEM II Set košara na izvlačenje

Visina ormarića H [mm]	Širina ormarića KB [mm]	ARENA antracit / antracit okvir	ARENA style antracit / antracit okvir	ARENA style bijeli / krom / srebrni okvir	ARENA klasični bijeli / kromi / srebrni okvir	Broj košara
800	600	F005273	F005276	F005279	F005282	3
1100	450	F005265	F005267	F005269	F005271	4
	600	F005274	F005277	F005280	F005283	
1700	450	F005266	F005268	F005270	F005272	5
	600	F005275	F005278	F005281	F005284	

Sadržaj paketa: Okvir i dodaci, skup košara.

## ● TANDEM II Zamjenska Košarica



● ARENA, antracit

● ARENA style antracit

○ ARENA style bijeli / krom

○ Klasika ARENA, klasični bijeli / krom

Širina ormarića KB [mm]	ARENA, antracit	ARENA style antracit	ARENA style bijeli / krom	ARENA klasični bijeli / krom
450	F005285	F005286	F005287	F005288
600	F005289	F005290	F005291	F005292

Pakiran za 1 košaru.

## ● TANDEM II Dodaci

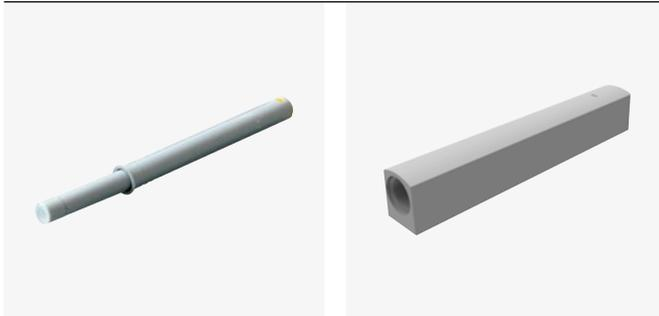

○ F005179

○ F005178

- Koristi se za push to open otvaranje vrata

Tip	Specifikacija	Sivo
Push-to-open za bušenje	26–48 N	F005179
Push-to-open adapter	Za vanjsku instalaciju	F005178

# Kessecböhmer TANDEM strana

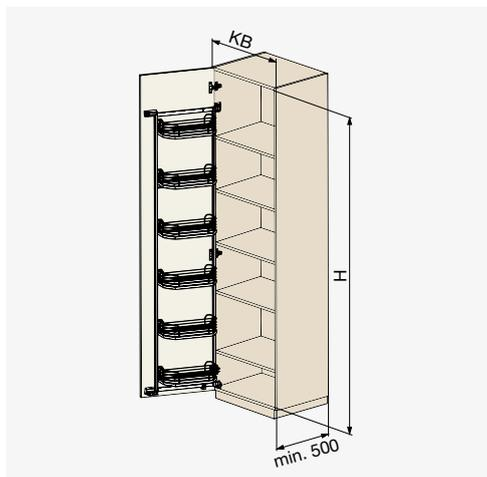

- Može se također koristiti odvojeno bez TANDEM II
- Može se nadograditi s Youboxx skupovima
- Kada se koristi odvojeno, interne police moraju biti smanjene:
  - s klasičnim košarama za 175 mm
  - s Youboxx skupovima za 135 mm
- Ukupni kapacitet punjenja 25 kg

## ● TANDEM Sporedni skup vrata sa policama

Visina ormarića H [mm]	Širina ormarića KB [mm]	ARENA antracit / antracit okvir	ARENA style antracit / antracit okvir	ARENA style bijeli / krom / srebrni okvir	ARENA klasični bijeli / kromi / srebrni okvir	Broj košara
600	450	F005225	F005229	F005233	F005237	2
	600	F005241	F005245	F005249	F005253	
800	450	F005226	F005230	F005234	F005238	3
	600	F005242	F005246	F005250	F005254	
1100	450	F005227	F005231	F005235	F005239	4
	600	F005243	F005247	F005251	F005255	
1700	450	F005228	F005232	F005236	F005240	5
	600	F005244	F005248	F005252	F005256	

Sadržaj paketa: Okvir i dodaci, skup košara.

## ● TANDEM bočna zamjenska košarica



● ARENA antracit



● ARENA style antracit



○ ARENA style bijeli / krom



○ Klasika ARENA, klasični bijeli / krom

Širina ormarića KB [mm]	ARENA antracit	ARENA style antracit	ARENA style bijeli / krom	ARENA klasični bijeli / krom
450	F005257	F005258	F005259	F005260
600	F005261	F005262	F005263	F005264

Pakiran za 1 košaru.

## ● TANDEM bočni Dodaci

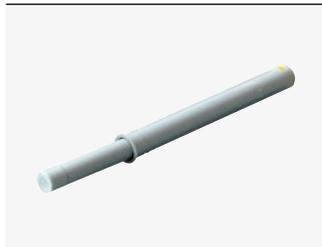

Ⓜ F005293

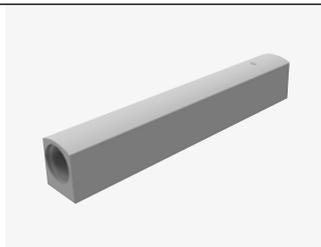

Ⓜ F005178

- Koristi se za push to open otvaranje vrata

Tip	Specifikacija	Sivo
Push-to-open za bušenje	17–23 N	F005293
Push-to-open za adapter	Za eksternu instalaciju	F005178

## ● TANDEM II i TANDEM bočni Youboxx



● Set 1 antracit – F005296



● Set 4 antracit – F005297



● Set 13 antracit – F005298



○ Set 13 bijela – F005294



● Set 7 antracit – F005299



● Set 12 antracit – F005300

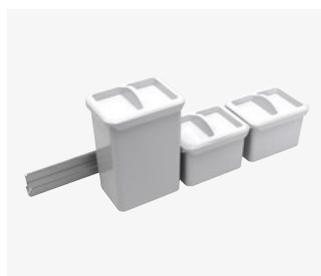

○ Set 12 bijela – F005295



Širina ormarića [mm]	Tip	Antracit		Bijela	
		Set	Model	Set	Model
450	Set 1		F005296	x	
	Set 4		F005297	x	
	Set 13		F005298		F005294
600	Set 7		F005299	x	
	Set 12		F005300		F005295

Set 1	1x kutija 2,1 L + 1x razdjelnik kutije + 1x potpora vodilice
Set 4	2x kutija 1,0 L + 2x poklopac kutije + 1x potpora vodilice
Set 7	1x kutija 2,1 L + 1x kutija 1,0 L + 1x box poklopac + 1x razdjelnik kutije + 1x potpora vodilice
Set 12	1x kutija 2,0 L + 2x kutija 1,9 L + 3x box poklopac + 1x potpora vodilice
Set 13	2x kutija 2,0 L + 2x poklopac kutije + 1x potpora vodilice

# Kesseböhmer DISPENSA

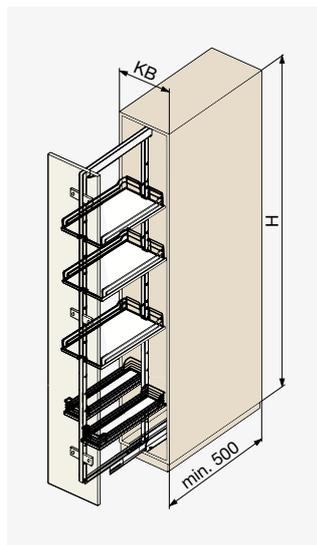

- Nosivost kapaciteta 100 kg

Za navedeni set je potrebno naručiti:

- Okvir
  - Vodilicu
  - Nosač prednje ploče
  - Bilo koji broj košara
- Ostali predmeti su opcijski dodaci
  - 1 DISPENSA košarica može biti zamijenjena s 2 COMFORT II košare
  - Može se nadograditi s Youboxx skupovima

## ● DISPENSA

### Okvir

10



● Antracit



● Srebrno

Visina ormarića H [mm]	Antracit	Srebrno	Dubina ormarića [mm]
900–1300	F005302	F005301	min. 500
1200–1600	F005304	F005303	
1600–2000	F005306	F005305	
1800–2200	F005308	F005307	
1900–2300	F005310	F005309	



## ● DISPENSA Vodilica



Ⓢ F005314



Ⓢ F005316

Otvaranje	Tip prigušenja	Antracit	Srebno	Širina ormarića KB [mm]
Potpuno	Unutra / Van	F005315	F005314	min. 200
Djelomično	Unutra	F005317	F005316	min. 150

## ● DISPENSA Dodaci

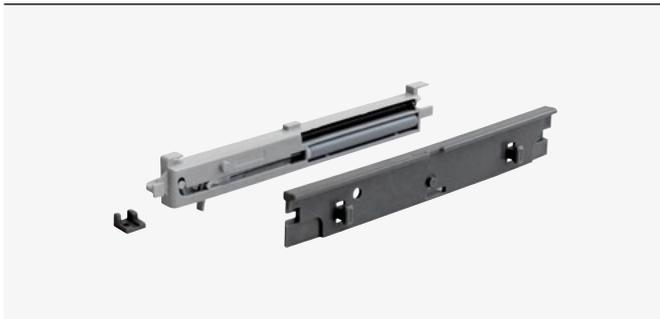

- Opcijski dodaci
- Dodatni stoper samo za vodilicu za proširenje

Tip	Kod
Dodatni prigušivač za otvaranje [za stavke F005316, F005317]	F005491

## ● DISPENSA eTouch Električno Otvaranje / Zatvaranje



Ⓢ F005342



Ⓢ F005176

- Opcijski dodaci
- Električni motor izbacuje smočnicu dodiranjem na vrata
- Pogodno za širine ormarića od 300 mm
- Djelomično otvaranje znači da su vrata otvorena za 44 mm
- Skup sadrži motor s EU-DIN utikačem, prednji senzor i adapter za prednju jedinicu senzora

Otvaranje vrata	Siva
Potpuni	F005342
Djelomični	F005176

01  
02  
03  
04  
05  
06  
07  
08  
09  
10  
11  
12  
13  
14  
15  
16  
17  
18

## ● DISPENSA

### Košarica



● ANTRACIT

● ANTRACIT style

○ ANTRACIT style BIJELO / KROM

○ KLASIKA ANTRACIT, KLASIČNI BIJELO / KROM

Širina ormarića KB [mm]	ANTRACIT	ANTRACIT style	ANTRACIT style BIJELO / KROM	ANTRACIT KLASIČNI BIJELO / KROM	Širina [mm]
150	F005180	F005184	F005191	F005311	100
200	x	F005185	F005192	F005312	150
250	x	x	x	F005313	200
300	F005181	F005186	F005193	F005198	250
400	F005182	F005187	F005194	F005199	350
450	F005183	F005188	F005195	F005200	400
500	x	F005189	F005196	F005201	450
600	x	F005190	F005197	F005202	550

Pakiran za 1 košaru.

## ● DISPENSA II

### Usko Side Basket za DISPENSA



● ANTRACIT style

○ ANTRACIT style BIJELO / KROM

● ANTRACIT KLASIČNI BIJELO / KROM

Širina ormarića KB [mm]	ANTRACIT	ANTRACIT style	ANTRACIT style BIJELO / KROM	ANTRACIT KLASIČNI BIJELO / KROM	Širina 2 košara [mm]
300	x	F005365	F005369	F005373	2 × 110
400	x	F005366	F005370	F005374	2 × 160
500	x	F005367	F005371	F005375	2 × 210

2 COMFORT II košare zamijene 1 DISPENSA Basket. Pakiran za 1 košaru.

## ● DISPENSA

### Nosači stranice na prednjem panelu



Širina ormarića [mm]	Antracit	Srebro
150	F005323	F005322
200	F005325	F005324
300	F005327	F005326
400	F005329	F005328
450	F005331	F005330
500	F005333	F005332
600	F005335	F005334

Set od 2 stranice.

● DISPENSA

Prednji Panel Za Povezivanje



- Opcijski dodaci
- Koristite 2 poveznice za povezivanje na prednji panel sastavljen od 2 ili više dijelova

Širina [mm]	Antracit	Srebro
110	F005337	F005336
230	F005339	F005338

Pakiranje 1 komad.

● DISPENSA

Prednji stabilizator



- Opcijski dodaci
- Instaliraj na bilo koji položaj
- Koristi se za stabilizirati središnji dio visoke prednje ploče

Antracit	Srebro
F005341	F005340

Pakiranje 1 komad.

● DISPENSA

Youboxx



● Set 1 antracit – F005344

● Set 3 Antracit – F005346

○ Set 1 Bijela – F005343

○ Set 3 Bijela – F005345

Tip	Antracit	Bijela
Set 1	F005344	F005343
Set 3	F005346	F005345

Skupovi sadrže:

- Set 1 2x kutija 1,0 L + 1x kutija 2,1 + 2x kutija 2,0 L + 1x box holder + 2x poklopac kutije + 2x potpora kutije
- Set 3 2x kutija 1,0 L + 2x kutija 2,1 L + 1x razdjelnik kutije + 2x poklopac kutije + 2x potpora tračnica

● DISPENSA

Stalak za začine



- Objesiti umjesto bilo koje košare na okvir s obje strane

Antracit	Širina [mm]	Dubina [mm]	Visina [mm]
F005347	465	85	33,5

# Riex GX53 / GX58

## Jedinica smočnice

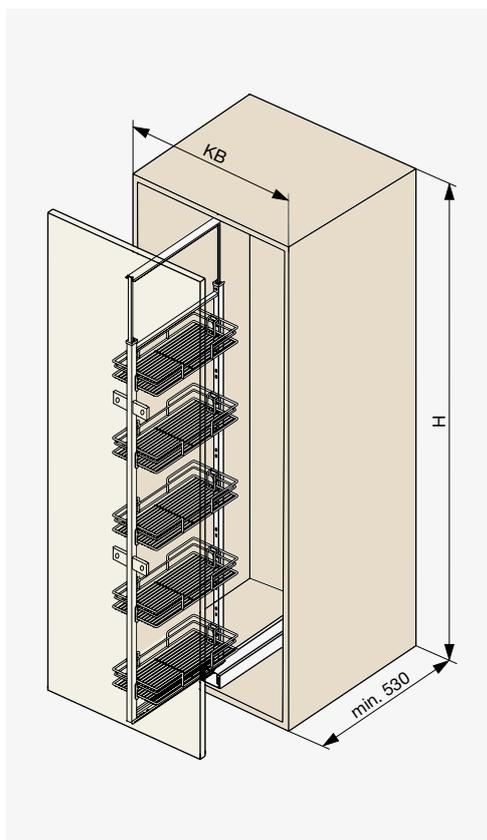

- Nosivost kapaciteta 90 kg
- Mehanizam za meko zatvaranje
- Košare i nosače se pakiraju na 1 komad

Za navedeni set je

- potrebno naručiti:
- Okvir s vodilicom
  - Nosače prednje ploče
  - Bilo koji broj košara

10

### ● Riex GX53 / GX58 okvir s vodilicom



● Tamno sivo



○ Bijela

Visina ormarića H [mm]	Tamno sivo	Bijela	Preporučeni broj košara	Dubina ormarića [mm]
1250–1400	F001858	F001852	4	min. 530
1400–1550	F001859	F001853	5	
1550–1700	F001860	F001854	6	
1700–1850	F001861	F001855	7	
1850–2000	F001862	F001856	7	
2000–2150	F001863	F001857	7	

## ⊕ Riex GX53 / GX58

### Nosač za vrata



● Tamno sivo



○ Bijela

- Moraju se naručiti minimalno 2 nosača za vrata
- Preporučamo korištenje 3 nosača za vrata od visine 1700 mm

Širina ormarića KB [mm]	Tamno sivo	Bijela
300	F004874	F004875
400	F004876	F004877
450	F004878	F004879

Pakiran za 1 nosač.

## ⊕ Riex GX53

### Košara

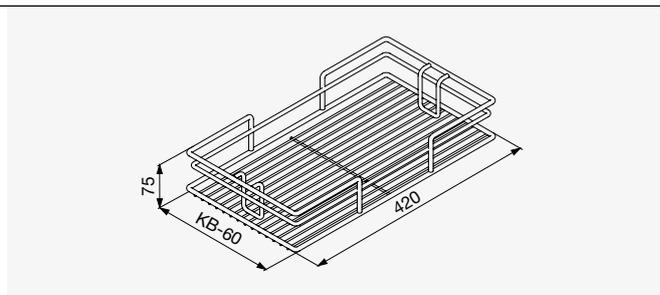
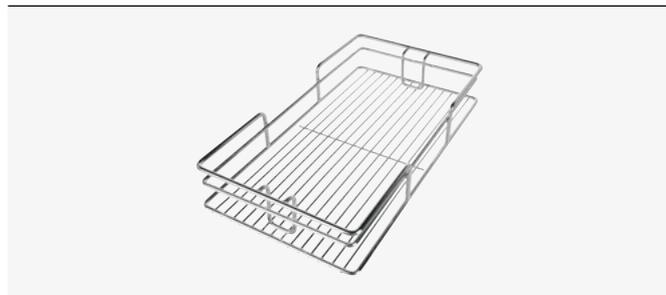

Širina ormarića KB [mm]	Krom	Širina [mm]	Dubina [mm]	Visina [mm]
300	F001864	240	420	75
400	F001865	340		
450	F001866	390		

Pakiran za 1 košaru.

## ⊕ Riex GX58

### Puna Donja Košarica

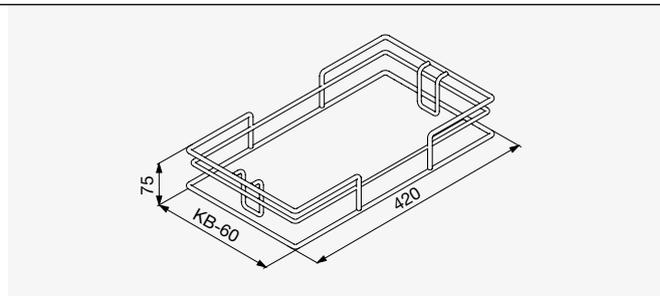

Širina ormarića KB [mm]	Tamno sivo	Bijela	Širina [mm]	Dubina [mm]	Visina [mm]
300	F001867	F001870	240	420	75
400	F001868	F001871	340		
450	F001869	F001872	390		

Pakiran za 1 košaru.

01  
02  
03  
04  
05  
06  
07  
08  
09  
10  
11  
12  
13  
14  
15  
16  
17  
18

# Izvlačne košare – kutne

10



# Kesseböhmer LeMans II

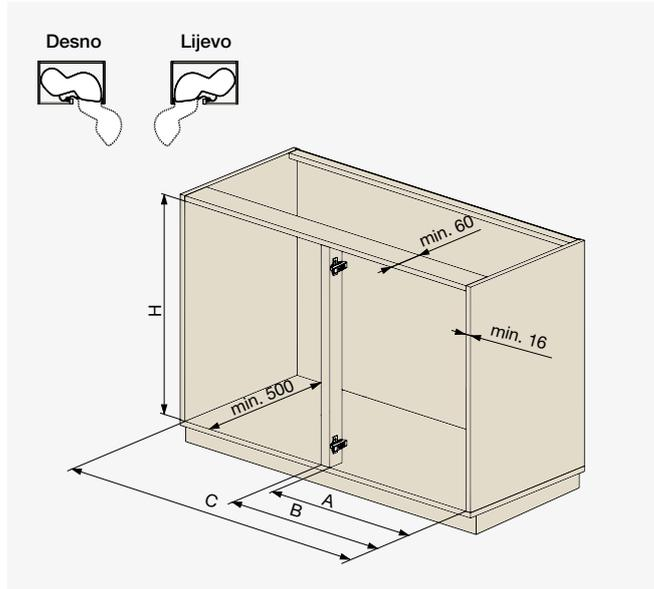

- Nosivost 25 kg po košari
- Kut otvaranja vrata od 85° omogućuje da se košare potpuno izvlače
- Košare podesive visine
- ClickFixx sustav za brzu montažu bez pogrešaka i bez alata
- Prigušeno samozatvaranje [opcionarno]
- 70% više prostora za pohranjivanje od osnovnog kutnog ormarića sa policama bez izvlačne košare – kutne

**Za sastavni sklop je potrebno naručiti:**

- Axle s dodacima
- Skup košara
- Skup dampera [opcijski]

## ● LeMans II Osovina s dodacima



① Axle



② Bočni profil ormara

**Sadržaj paketa:**

- 1 veličina podešavanja osovine
- 1 profil strane ormarića
- 1 gornji konektor
- 1 osovina na dnu

Visina ormarića H [mm]	Antracit	Bijela
600–750	F005416	F005415
720–900	F005418	F005417
1250	F005420	F005419

01  
02  
03  
04  
05  
06  
07  
08  
09  
10  
11  
12  
13  
14  
15  
16  
17  
18

## ● LeMans II Set košarica

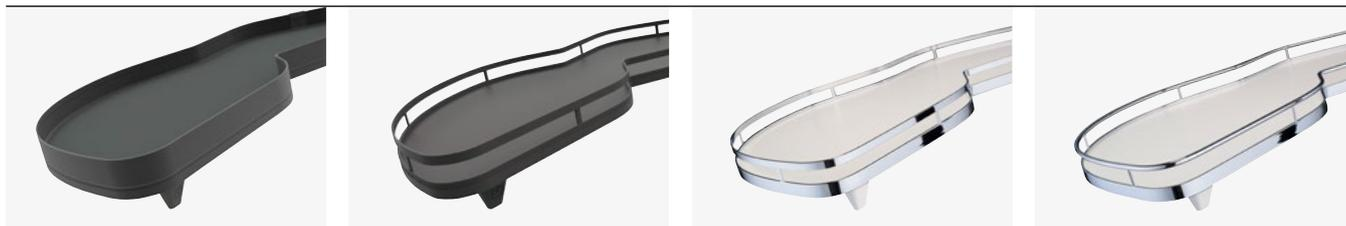

● ANTRACIT      ● ANTRACIT style      ○ ANTRACIT style BIJELO / KROM      ○ KLASIKA ANTRACIT, KLASIČNI BIJELO / KROM

Širina ormarića B [mm]	Smjer okretanja	ANTRACIT	ANTRACIT style	ANTRACIT style BIJELO / KROM	ANTRACIT klasični BIJELO / KROM	Širina ormarića C [mm]	Dimenzija A [mm]	Dubina ormarića [mm]
400	Desno	F005492	F005494	F005496	F005407	min. 764	361–368	min. 500
	Lijevo	F005493	F005495	F005497	F005408			
450	Desno	F005389	F005395	F005401	F005409	min. 800	411–418	
	Lijevo	F005390	F005396	F005402	F005410			
500	Desno	F005391	F005397	F005403	F005411	min. 910	461–468	
	Lijevo	F005392	F005398	F005404	F005412			
600	Desno	F005393	F005399	F005405	F005413	min. 960	561–568	
	Lijevo	F005394	F005400	F005406	F005414			

Set od 2 košara.

## ● LeMans II Set Soft STOPP plus Prigušivači

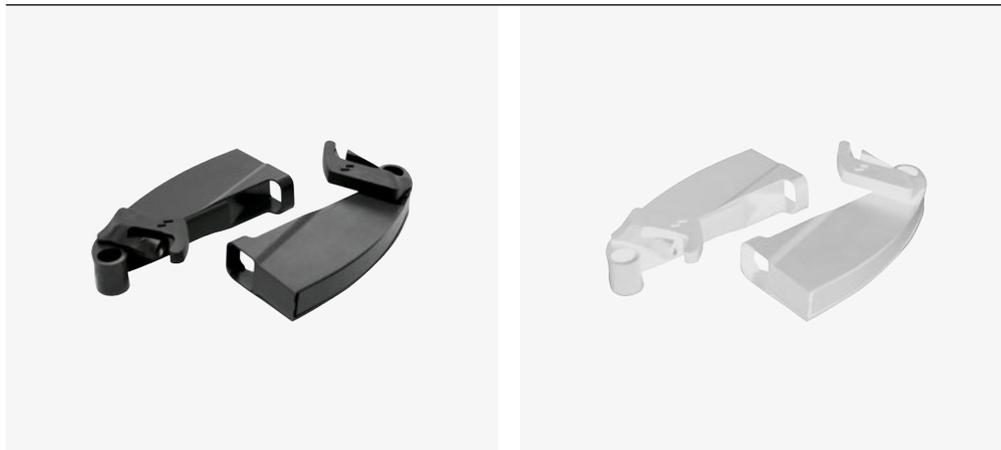

● ANTRACIT      ○ BIJELO

- Opcijski dodaci
- Koristi se za soft-close za vrijeme umetanja košara

Smjer okretanja	ANTRACIT	BIJELO
Desno	F005424	F005423
Lijevo	F005422	F005421

Set od 2 prigušivača.



# Kesseböhmer MagicCorner

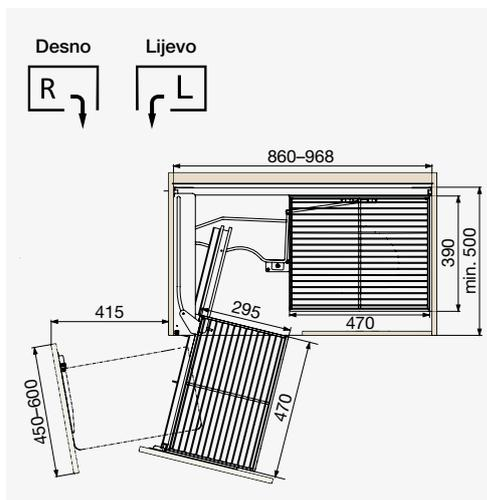

- Lagani mehanizam za zatvaranje
- Za 900 mm i 1000 mm ormariće kutka

**Kapacitet nosivosti:**

- Unutarnje košare-ukupno 18 kg
- Vanjske košare-ukupno 14 kg

**Za sastavni sklop je potrebno naručiti:**

- Okvir s mehanizmom
- Set košara

## ● MagicCorner Okvir s Mehanizmom



● Srebrno

Smjer okretanja	Antracit	Srebrno	Širina ormarića [mm]	Dubina ormarića [mm]	Visina ormarića [mm]	Širina ormarića [mm]
Desno	F005425	F005427	860-968	min. 500	min. 525	450-600
Lijevo	F005426	F005428				

01  
02  
03  
04  
05  
06  
07  
08  
09  
10  
11  
12  
13  
14  
15  
16  
17  
18

## ● MagicCorner Skup košarica



● ARENA style antracit



○ ARENA style bijeli / krom



○ Klasika ARENA, klasični bijeli / krom

ARENA style  
antracit

F005429

ARENA style  
bijeli / krom

F005430

ARENA klasični  
bijeli / krom

F005431

Set od 4 košara.

## ● MagicCorner Pribor



① F005179



① F005178

- Koristi se za push to open otvaranje vrata

10

Tip	Specifikacija	Antracit	Siva
Push-to-open za bušenje	26–48 N	F005432	F005179
Push-to-open adapter	Za eksterne instalacije	F005433	F005178

# Kesseböhmer Revo 90°

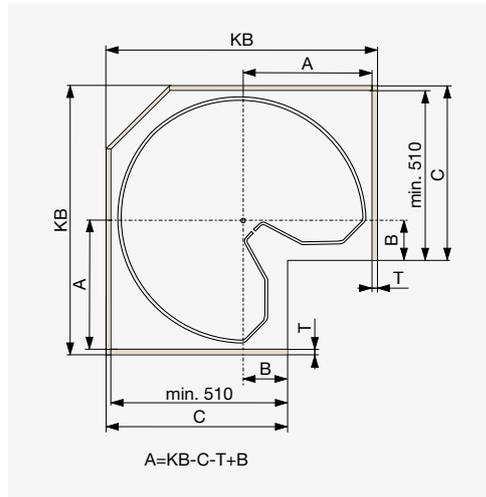

- Vrata se rotiraju pomoću karusela
- Vrata se nježno odmiču, karusel se zaokreće polagano, te se vrata zatvaraju automatski.

**Za sastavni sklop je potrebno naručiti:**

- Skup košara
- Rotirajući mehanizam s dodatcima

## ● Revo 90° Skup košarica



● ARENA antracit



● ARENA style antracit



○ ARENA style bijeli / krom

Širina ormarića KB [mm]	ARENA antracit	ARENA style antracit	ARENA style bijelo / krom	Dimenzija B [mm]	Dimenzija C [mm]	Dimenzija T [mm]
800	F005443	F005444	F005445	140,5	545–560	16–19
900	F005203	F005441	F005442	90,5		

Set od 2 košara.

## ● Revo 90° Rotirajući mehanizam sa priborom



● Srebrno

**Sadržaj paketa:**

- 4 prednja nosača panela
- 1 cam medij
- 1 rotirajuće ležište
- 1 gornji pregradni panel

Visina ormarića [mm]	Antracit	Srebro
660–860	F005446	F005447

# Kesseböhmer Carousel 270°

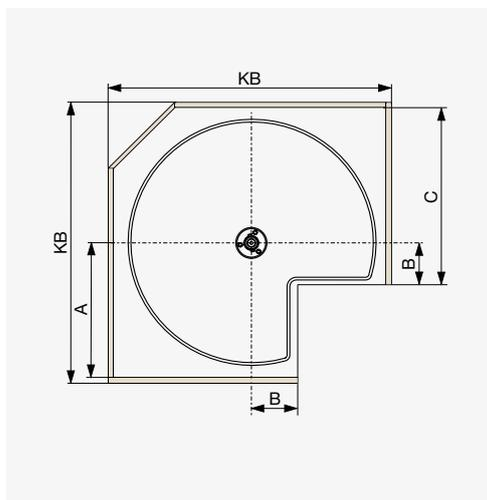

- Rotirajuće košare koje se montiraju na osovina

Za set je potrebno naručiti:

- Skup košara
- Osovina

## ● Carousel 270° Set košarica

10



● ARENA antracit



● ARENA style antracit



○ ARENA style bijeli / krom

Širina ormarića KB [mm]	ARENA antracit	ARENA style antracit	ARENA style bijelo / krom	Dimenzija A [mm]	Dimenzija B [mm]	Dimenzija C [mm]
800	F005436	F005437	F005438	min. 360	min. 120	min. 480
900	F005458	F005434	F005435	min. 420	min. 90	min. 510

Set od 2 košara.

## ● Carousel 270° Osovina



Visina [mm]	Krom
655–745	F005439
742–832	F005440

# Riex GP68

## Košare na izvlačenje

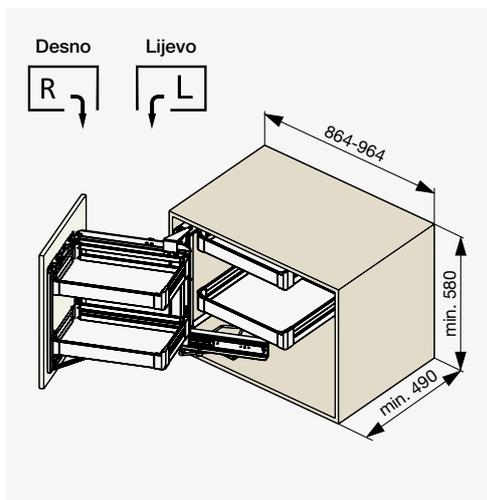

- Mehanizam za soft-close zatvaranje sa pripojenim vratima
- Tamno sive košare s punim dnom
- Okvir tamnosive boje

#### Nosivost:

- Unutarnje košare – ukupno 16 kg
- Vanjske košare – ukupno 10 kg

#### Za montažu potrebno je naručiti:

- Kutni mehanizam
- Set košara

### ⊕ Riex GP68

#### Kutni mehanizam



Smjer otvaranja	Tamno sivo	Dubina ormarića [mm]	Visina ormarića [mm]	Širina ormarića [mm]
Desno	F001818	min. 490	min. 580	864-964
Lijevo	F001817			

### ⊕ Riex GP68

#### Set košarica

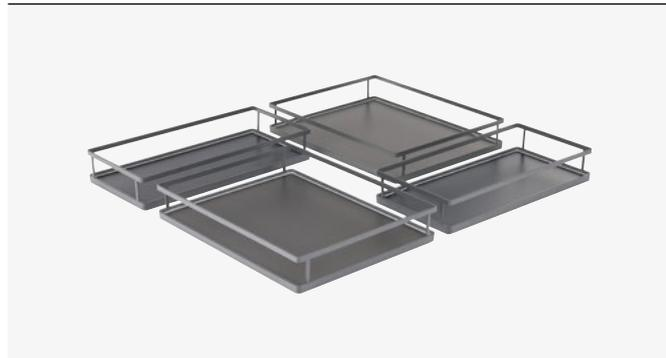

Broj košara	Tamno sivo
4	F001820

# Riex GP58

## Košare na izvlačenje

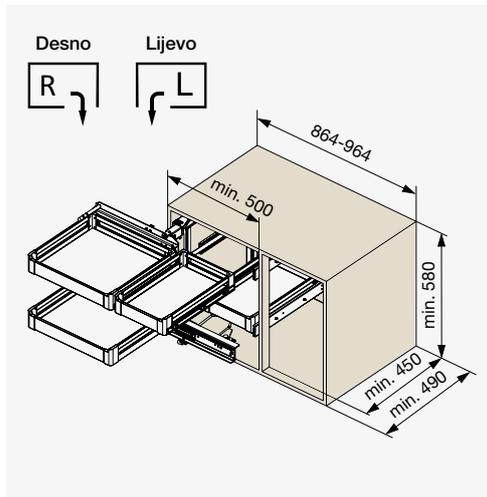

- Mehanizam za soft-close zatvaranje bez spojenih vrata
- Tamno sivi pod košare
- Tamno sive košare

#### Nosivost:

- Unutarnje košare – ukupno 16 kg
- Vanjske košare – ukupno 10 kg

#### Za montažu potrebno je naručiti:

- Kutni mehanizam
- Set košara

### ➤ Riex GP58

#### Kutni mehanizam



Smjer okretanja

Tamno sivo

Dubina ormarića [mm]

Visina ormarića [mm]

Širina ormarića [mm]

Desno

F001828

min. 490

min. 580

864-964

Lijevo

F001827

### ➤ Riex GP58

#### Skup košarica



Broj košara

Tamno sivo

4

F001830

# Riex GP63

## Košare na izvlačenje

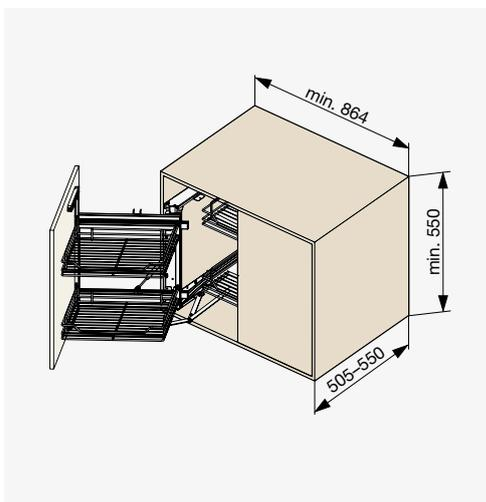

- Mehanizam za lagano zatvaranje s pričvršćenim vratima
- Košare od kromirane žice
- Okvir svijetlosive boje
- Kutni mehanizam i set košara pakirani su zajedno

#### Kapacitet nosivosti:

- Unutarnje košare – ukupno 10 kg
- Vanjske košare – ukupno 10 kg

### ☛ Riex GP63

#### Skup



Smjer okretanja	Krom	Dubina ormarića [mm]	Visina ormarića [mm]	Širina ormarića [mm]
Desno / lijevo	F001832	505-550	min. 550	min. 864

# Riex GP28 Carousel

## ⊕ Riex GP28 180° Set

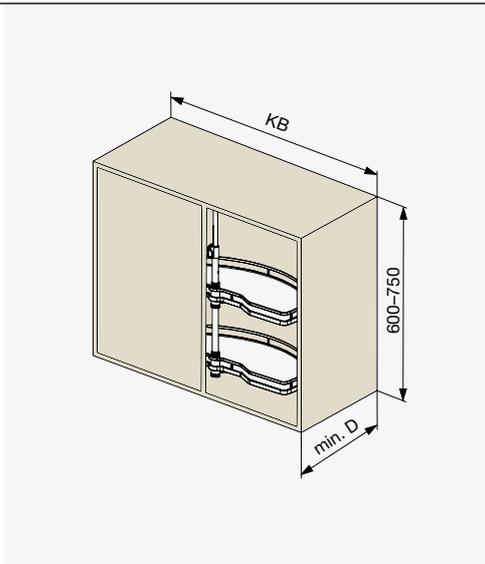

- Tamno sive košare
- Osovina i set košara su pakirani zajedno
- Nosivost 15 kg po košari

10

Širina ormarića KB [mm]	Tamno sivo	Dubina kabineta D [mm]	Visina ormarića [mm]
800	F001212	max. 500	600-750

## ⊕ Riex GP28 270° Set

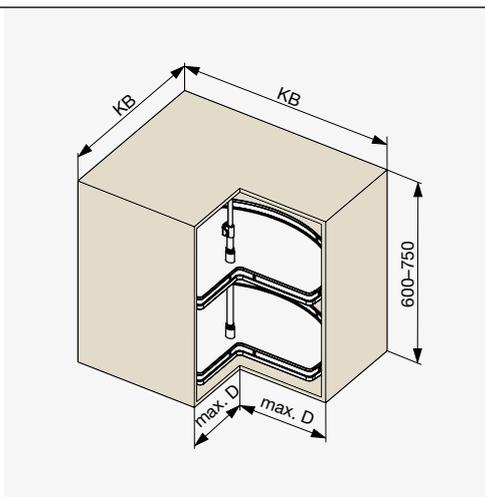

- Tamno sive košare
- Osovina i set košara su pakirani zajedno
- Nosivost 15 kg po košari

Širina ormarića KB [mm]	Tamno sivo	Dubina kabineta D [mm]	Visina ormarića [mm]
800	F001213	max. 320	600-750
900	F001214	max. 400	



# Riex GP13 Carousel

## ⊕ Riex GP13 180° Set

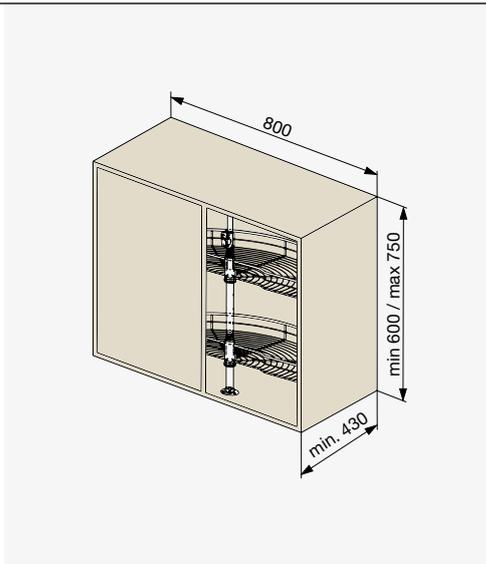

- Kromirane žičane košare
- Osovina i set košara su pakirani zajedno
- Punjenje kapaciteta 15 kg po košari

Širina ormarića [mm]	Krom	Dubina ormarića [mm]	Visina ormarića [mm]
800	F001208	min. 430	600–750

## ⊕ Riex GP13 270° Set

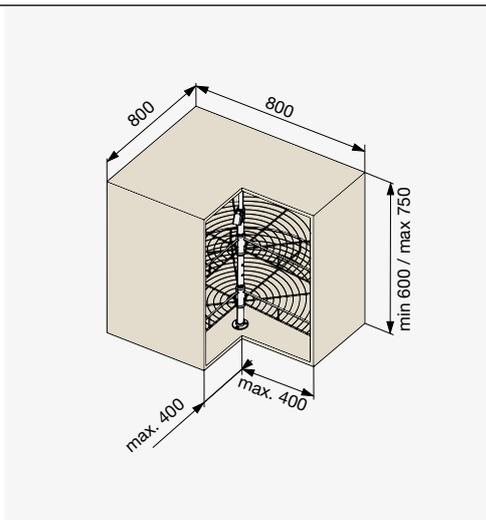

- Kromirane žičane košare
- Osovina i set košara su pakirani zajedno
- Nosivost kapaciteta 15 kg po košari

Širina ormarića [mm]	Krom	Dubina ormarića [mm]	Visina ormarića [mm]
800	F001209	max. 400	600–750

# Izvlačne košare – male

10



# Kesseböhmer br. 15

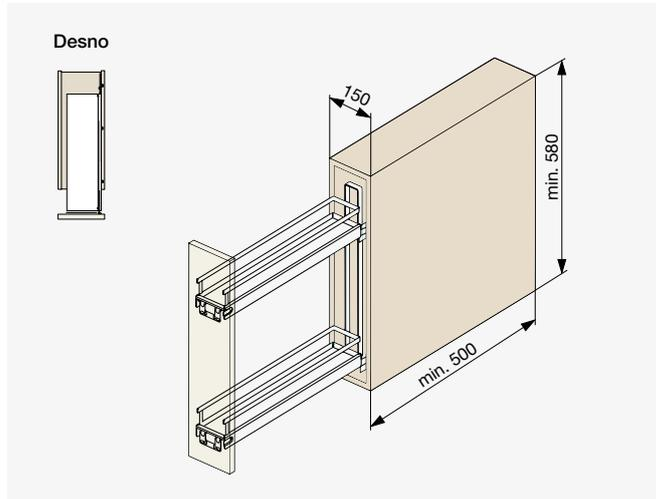

- Nosivost 6 kg po košari
- Potpuno izvlačenje skrivenih vodilica s soft-close zatvaranjem
- Bočna montaža
- Samo desna verzija
- 3D podešavanje prednje ploče

## ● No. 15 Set



● Stil antracit



● K linija Antracit



● Stil krom

### Sadržaj paketa:

- 2 košare s prednjim 3D držačima
- 2 skrivene vodilice



● Stil krom držač



● Stil krom držača pretinca za pečenje

Tip košare	Antracit	Krom	Strana	Širina ormarića [mm]	Dubina ormarića [mm]	Visina ormarića [mm]
Stil	F005348	F005349	Desna	150	min. 500	min. 580
K linija	F005350	x				
Stil držač krpe / ručnika	F005351	F005352				
Stil držač pretinca za pečenje	x	F005353				

01  
02  
03  
04  
05  
06  
07  
08  
09  
10  
11  
12  
13  
14  
15  
16  
17  
18

## ● No. 15 Dijelitelj



● Stil krom

Tip košare	Antracit	Krom
Stil	F005355	F005354
K linija	F005356	x

Pakiran za 1 razdjelnik.

## ● No. 15 Dodaci



① F005177



① F005178

- Služi za push to open otvaranje

Tip	Specifikacije	Kod
Push-to-open za bušenje	22–34 N	F005177
Push-to-open za adapter	Za vanjsku instalaciju	F005178

# Kesseböhmer COMFORT II

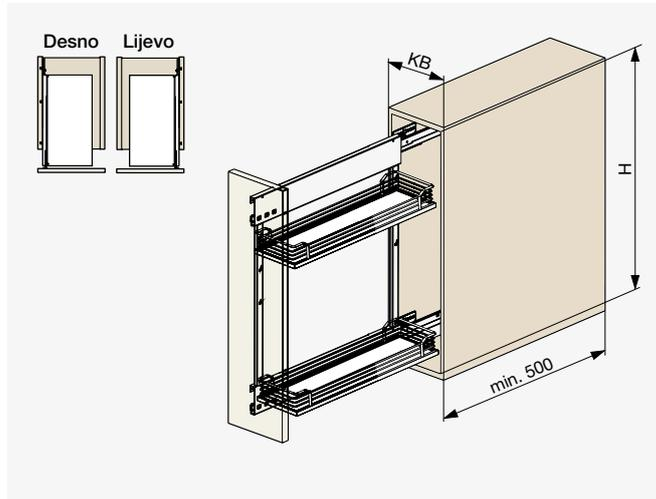

- Nosivost 20 kg
- Potpuno izvlačenje skrivenih vodilica s soft-close zatvaranjem
- Bočna montaža
- Samo desna verzija
- 3D podešavanje prednje ploče

Za montažu potrebno je naručiti:

- Okvir s vodilicama
- Košare

Preporučena konfiguracija:

- 1 set okova
- 2 COMFORT II košare

## ● COMFORT II Okvir s Klizačima



● Antracit



● Srebrno

Sadržaj paketa:

- 1 okvir
- 1 par GRASS Nova vodilica s potpunim izvlačenjem
- 1 set 3D nosača prednje ploče

Visina ormarić H [mm]	Smjer otvaranja	Antracit	Srebro	Dubina ormarića [mm]
min. 654	Desni	F005361	F005357	min. 500
	Lijevo	F005362	F005358	
min. 686	Desni	F005363	F005359	
	Lijevo	F005364	F005360	

01  
02  
03  
04  
05  
06  
07  
08  
09  
10  
11  
12  
13  
14  
15  
16  
17  
18

## ● COMFORT II

### Košarica



● ARENA style antracit

○ ARENA style bijeli / krom

○ ARENA klasični bijeli / krom

Širina ormarića KB [mm]	ARENA style antracit	ARENA style bijeli / krom	ARENA klasični bijeli / krom	Širina [mm]
200	F005365	F005369	F005373	110
250	F005366	F005370	F005374	160
300	F005367	F005371	F005375	210
400	F005368	F005372	F005376	320

Pakiran za 1 košaru.

## ● COMFORT II

### Stalak za začine



Antracit

Širina [mm]

Dubina [mm]

Visina [mm]

F005377

479

133

76

## ● COMFORT II

### Dodaci

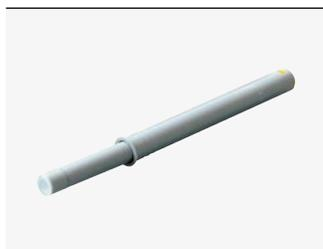

① F005177

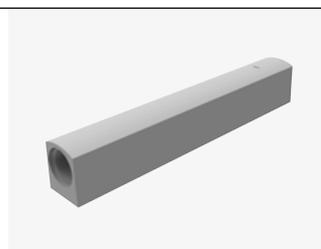

① F005178

- Koristi se za neručno otvaranje vrata

Tip	Specifikacija	Sivo
Push-to-open za bušenje	22–34 N	F005177
Push-to-open adapter	Za vanjsku instalaciju	F005178

# Kesseböhmer DISPENSA junior III

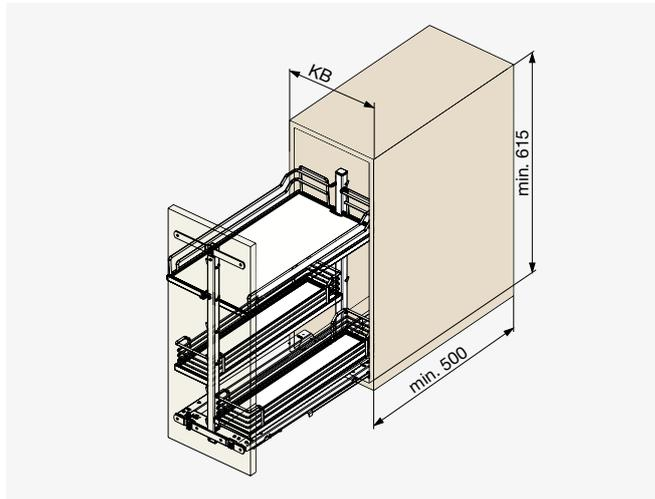

- Potpuno izvlačenje skrivenih vodilica s mekim zatvaranjem
- Donja montaža
- Podešavanje 3D prednje ploče

**Za montažu potrebno je naručiti:**

- Okvir s vodilicama
- Košare

**Predložena konfiguracija:**

- 1 odgovarajući set
- 2 DISPENSA košara
- 1 DISPENSA košarica može biti zamijenjena s 2 COMFORT II košara
- Može se nadograditi s Youboxx skupovima

## ● DISPENSA junior III Okvir s vodilicama



Ⓢ F005379



Ⓢ F005378

**Sadržaj paketa:**

- 1 okvir
- 1 par vodilica
- 1 skup 3D držaka prednje ploče

Širina ormarića KB [mm]	Antracit	Srebro	Dubina ormarića [mm]	Visina ormarića [mm]
300–450	F005379	F005378	min. 500	min. 615
500–600	F005381	F005380		

01  
02  
03  
04  
05  
06  
07  
08  
09  
10  
11  
12  
13  
14  
15  
16  
17  
18

## ● DISPENSA junior III Košarica



● ARENA antracit

● ARENA style antracit

○ ARENA style bijeli / krom

○ ARENA klasični bijeli / krom

Širina ormarića KB [mm]	ARENA antracit	ARENA style antracit	ARENA style bijeli / krom	ARENA klasični bijeli / krom	Širina [mm]
300	F005181	F005186	F005193	F005198	250
400	F005182	F005187	F005194	F005199	350
450	F005183	F005188	F005195	F005200	400
500	x	F005189	F005196	F005201	450
600	x	F005190	F005197	F005202	550

Pakiran za 1 košaru.

## ● COMFORT II Uska bočna košara za DISPENZA



● ARENA style antracit

○ ARENA style bijeli / krom

○ ARENA klasični bijeli / krom

Širina ormarića KB [mm]	ARENA antracit	ARENA style antracit	ARENA style bijeli / krom	ARENA klasični bijeli / krom	Širina 2 košara [mm]
300	x	F005365	F005369	F005373	2 × 110
400	x	F005366	F005370	F005374	2 × 160
500	x	F005367	F005371	F005375	2 × 210

2 COMFORT II košare zamijene 1 DISPENZA Basket. Pakiran za 1 košaru.



● **DISPENSA junior III**  
**Youboxx**



● Set 1 antracit – F005344



● Set 3 antracit – F005346



○ Set 1 bijela – F005343



○ Set 3 bijela – F005345



Tip	Antracit	Bijela
Set 1	F005344	F005343
Set 3	F005346	F005345

**Skupovi sadrže:**

Set 1 2x kutija 1,0 L + 1x kutija 2,1 + 2x kutija 2,0 L + 1x držač koševa + 2x poklopac kutije + 2x potpora vodilice

Set 3 2x kutija 1,0 L + 2x kutija 2,1 L + 1x razdjelnik kutije + 2x poklopac kutije + 2x potpora vodilice

01  
02  
03  
04  
05  
06  
07  
08  
09  
10  
11  
12  
13  
14  
15  
16  
17  
18

# Kesseböhmer DISPENSA junior uski

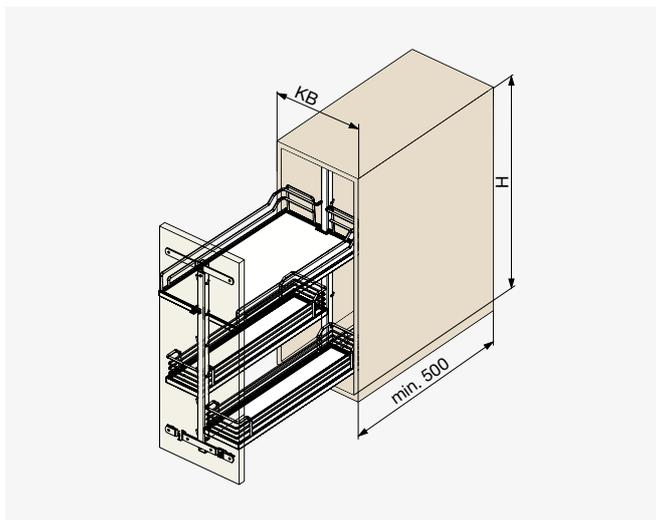

- Potpuno izvlačenje skrivenih vodilica s soft-close zatvaranjem
- Donja montaža
- 3D podešavanje prednje ploče

Za sastavni sklop je potrebno naručiti:

- Okvir s vodilicama
- Košare

Predložena konfiguracija:

- 1 odgovarajući set
- 2 DISPENSA košara
- 1 DISPENSA košarica može biti zamijenjena s 2 COMFORT II košara
- Može se nadograditi s Youboxx setovima

## ● DISPENSA junior uski Okvir s vodilicama

10



Sadržaj paketa:

- 1 okvir
- 1 adapter ploča
- 1 aluminijski profil
- 1 gornji konektor
- 1 par skrivenih vodilica
- 1 skup 3D držaka prednje ploče
- 1 skup seta materijala [isključujući vijke za carcass]

© F005384

Visina ormarića H [mm]	Antracit	Srebro	Dubina ormarića [mm]	Širina ormarića KB [mm]
640–728	F005385	F005384	min. 500	200–400
695–783	F005383	F005382		

Za širinu jedinice od 150 mm upotrijebite držač prednje ploče F005386 i F005387.

## ● DISPENSA junior uska košarica



● ARENA antracit

● ARENA style antracit

○ ARENA style bijeli / krom

○ ARENA klasični bijeli / krom

Širina ormarića KB [mm]	ARENA antracit	ARENA style antracit	ARENA style bijeli / krom	ARENA klasični bijeli / krom	Širina [mm]
150	F005180	F005184	F005191	F005311	100
200	x	F005185	F005192	F005312	150
300	F005181	F005186	F005193	F005198	250
400	F005182	F005187	F005194	F005199	350

Pakiran za 1 košaru.

## ● COMFORT II Uska bočna košarica za DISPENSA



● ARENA style antracit

○ ARENA style bijeli / krom

○ ARENA klasični bijeli / krom

Širina ormarića KB [mm]	ARENA antracit	ARENA style antracit	ARENA style bijeli / krom	ARENA klasični bijeli / krom	Širina 2 košara [mm]
300	x	F005365	F005369	F005373	2 × 110
400	x	F005366	F005370	F005374	2 × 160

2 COMFORT II košare zamijene 1 DISPENSA Basket. Pakiran za 1 košaru.

## ● DISPENSA junior uski

### Nosači prednje ploče za 150 mm ormarić



● Antracit



● Srebrno

- Opcijski dodaci

#### Sadržaj paketa:

- 1 gornja prednja zagrada panela
- 1 donja prednja zagrada panela

Antracit

Srebro

F005387

F005386

## ● DISPENSA uski

### Youboxx



● Set 1 antracit – F005344



● Set 3 antracit – F005346



○ Set 1 bijela – F005343



○ Set 3 bijela – F005345

10

Tip	Antracit	Bijela
Set 1	F005344	F005343
Set 3	F005346	F005345

#### Setovi sadrže:

- Postavi 1 2x kutija 1,0 L + 1x kutija 2,1 + 2x kutija 2,0 L + 1x držač noževa + 2x poklopac kutije + 2x potpora vodilice
- Postavi 3 2x kutija 1,0 L + 2x kutija 2,1 L + 1x razdjelnik kutije + 2x poklopac kutije + 2x potpora vodilice

## ● DISPENSA junior uski

### dodaci



⊙ F005179



⊙ F005178

- Koristi se za otvaranje vrata bez ručke

Tip	Specifikacija	Sivi
Push-to-open za bušenje	26–48 N	F005179
Push-to-open adapter	Za vanjsku instalaciju	F005178

# Kesseböhmer cleaningAGENT

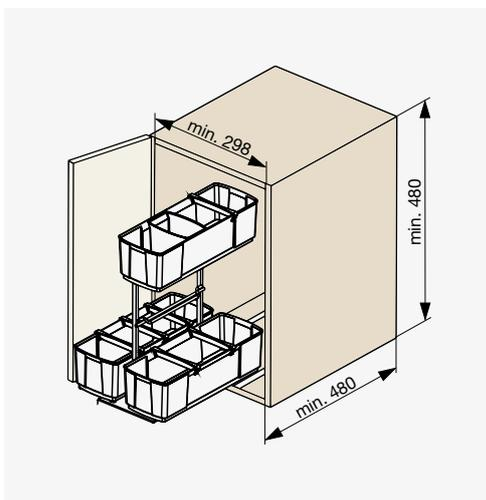

- Donja montaža
- Košara za nošenje s neklizajućim gumenim nožicama
- Svi plastični elementi se mogu ukloniti i prati [pogodno za pranje u perilici posuđa]
- Otporan na sve obično dostupne materijale za čišćenje kućanstva

## ● cleaningAGENT Set



© F005388

### Sadržaj paketa:

- 1 sustav okvira sa vodilicama
- 1 košara viseća na kuku s ručkom za jednostavno držanje
- 2 velike posude
- 1 mala posuda
- 6 pregrada

Sivo	Širina unutarnjeg ormarića [mm]	Visina ormarića [mm]	Dubina ormarića [mm]
F005388	298	480	480

01  
02  
03  
04  
05  
06  
07  
08  
09  
10  
11  
12  
13  
14  
15  
16  
17  
18

# Riex Bočne košare bez Okvira

## ⊕ Riex GD38

### Bočne košare s punim dnom

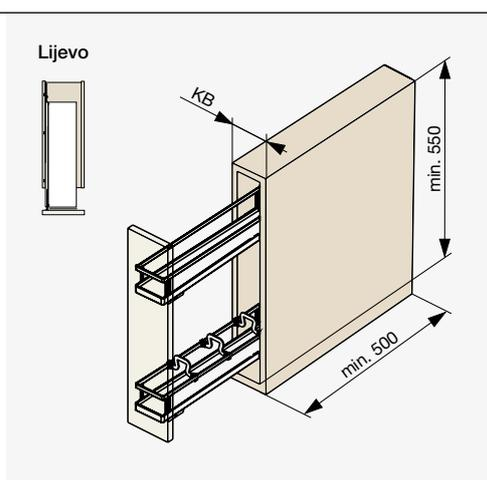

- Tamnosive košare s punim dnom
- Potpuno izvlačenje skrivenih vodilica s mekim zatvaranjem
- Samo lijeva verzija
- 3D nosači prednje ploče
- Sve komponente su pakirane zajedno

Širina ormarića KB [mm]	Tamno siva	Strana	Dubina ormarića [mm]	Visina ormarića [mm]
150	F001833	Lijevo	min. 500	min. 550
200	F003056			

## ⊕ Riex GD34

### Bočne žičane košare s Blum vodilicama

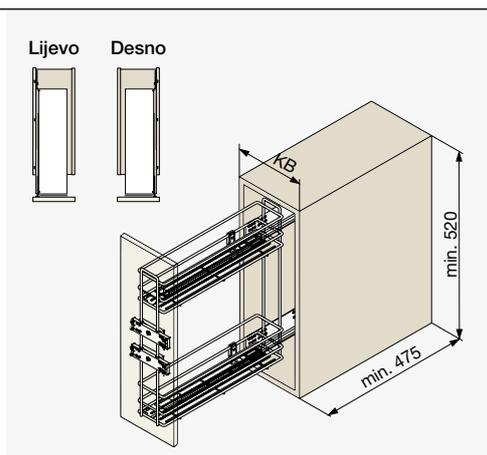

- Kromirane žičane košare
- Potpuno skriveni klizači s punim izvlačenjem i soft-close zatvaranjem
- 2D nosači prednje ploče
- Sve komponente su pakirane zajedno

Širina ormarića KB [mm]	Strana	Krom	Dubina ormarića [mm]	Visina ormarića [mm]
150	Desno	F001846	min. 475	min. 520
	Lijevo	F005160		
200	Desno	F001847		
	Lijevo	F005161		

## ⊕ Riex GD33

### Bočne žičane košare za skrivene vodilice

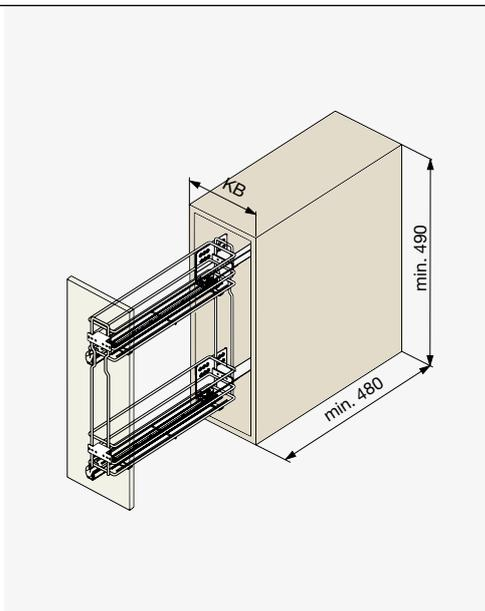

- Kromirane žičane košare
- Upotrebljivo s dužinom vodilica 450 mm samo
- Kompatibilno s Riex skrivenim vodilicama na str. 1.38–1.40
- Odjeljci za 3D prednji panel
- Desna / lijeva verzija
- Košare se pakiraju odvojeno bez vodilice

Za sastavni sklop je potrebno naručiti:

- Košare
- Vodilice

Širina ormarića [mm]	Krom	Strana	Dubina ormarića [mm]	Visina ormarića [mm]
150	F001848	Desna / lijeva	min. 480	min. 490
200	F001849			

## ⊕ Riex GD33

### Bočne žičane košare za kuglične vodilice

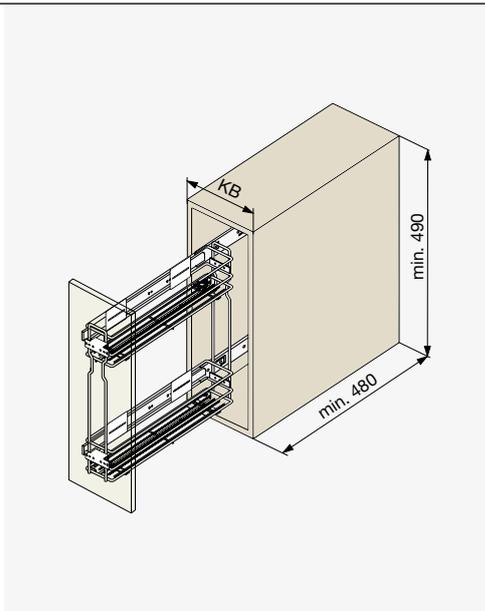

- Kromirane žičane košare
- Upotrebljivo s dužinom vodilice 450 mm samo
- Kompatibilni s Riex skrivenim vodilicama na str. 1.46–1.51
- Odjeljci za 3D prednji panel
- Desna / lijeva verzija
- Košare se pakiraju odvojeno bez vodilica

Za montažu potrebno je naručiti:

- Košare
- Vodilice

Širina ormarića [mm]	Krom	Strana	Dubina ormarića [mm]	Visina ormarića [mm]
150	F001850	Desna / lijeva	min. 480	min. 490
200	F001851			

# Riex Bočne Košare s okvirom

## ⊕ Riex GD48

### Bočne košare s punim dnom i okvirom

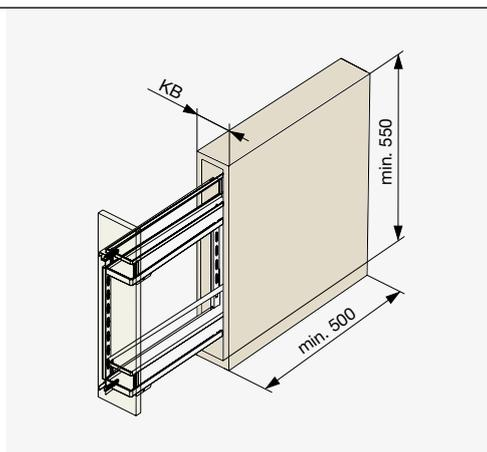

- Potpuno izvlačenje skrivenih vodilica s soft-close zatvaranjem
- Tamnosive košare s punim dnom
- Okvir tamnosive boje
- Lijeva / desna verzija
- 2D nosači prednje ploče
- Sve komponente su pakirane zajedno

Širina ormarića KB [mm]	Tamno sivo	Strana	Dubina ormarića [mm]	Visina ormarića [mm]
200	F001837	Desno / lijevo	min. 500	min. 550
250	F001839			
300	F001841			

10

## ⊕ Riex GD43

### Bočne žičane košare s okvirom

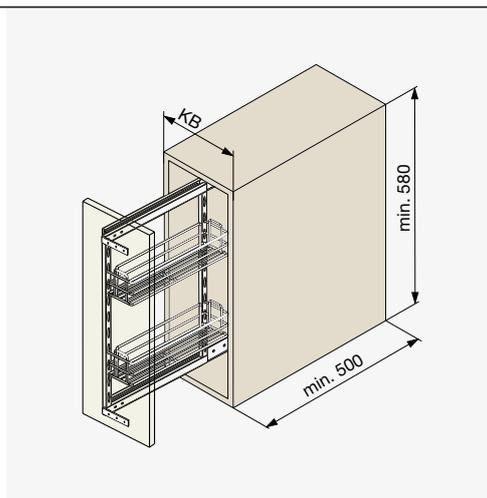

- Vodilice s kugličnim ležajevima s punim izvlačenjem i soft-close zatvaranjem
- Kromirane žičane košare
- Okvir svijetlosive boje
- Lijeva / desna verzija
- 2D nosači prednje ploče
- Sve komponente su pakirane zajedno

Širina ormarića KB [mm]	Krom	Strana	Dubina ormarića [mm]	Visina ormarića [mm]
200	F001218	Desno / lijevo	min. 500	min. 580
250	F001219			
300	F001220			



# Riex Donje Košare

## ⊕ Riex GD58 Donje Košare s Punim Dnom

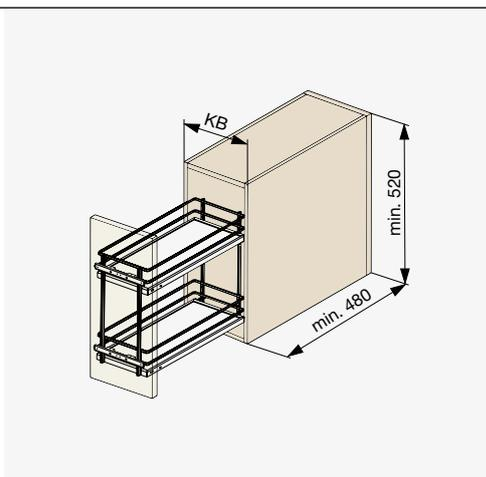

- Potpuno izvlačenje skrivenih vodilica s soft-close zatvaranjem
- Donja montaža
- Tamnosive košare s punim dnom
- Tamno sivi okvir
- 3D nosači prednje ploče
- Sve komponente su pakirane zajedno

Širina ormarića KB [mm]	Tamno sivo	Dubina ormarića [mm]	Visina ormarića [mm]
300	F001875	min. 480	min. 520
400	F001876		

## ⊕ Riex GD53 Donje Žičane Košare

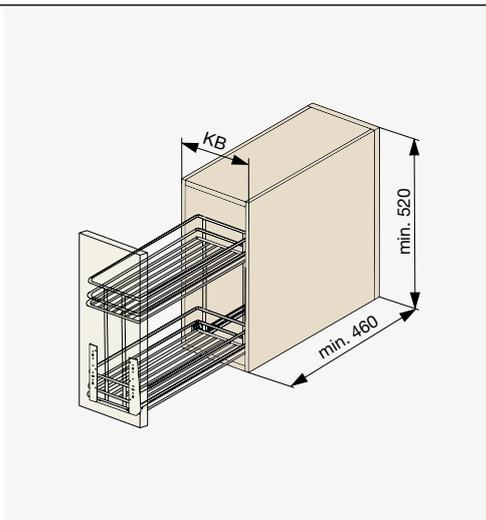

- Potpuno izvlačenje skrivenih vodilica sa soft-close zatvaranjem
- Donja montaža
- Kromirane žičane košare
- Tamno sivi okvir
- 2D nosača prednjeg panela
- Sve komponente su pakirane zajedno

Širina ormarića KB [mm]	Krom	Dubina ormarića [mm]	Visina ormarića [mm]
300	F001873	min. 460	min. 520
400	F001874		

# Kuhinjski dodaci

10



# Kesseböhmer iMove

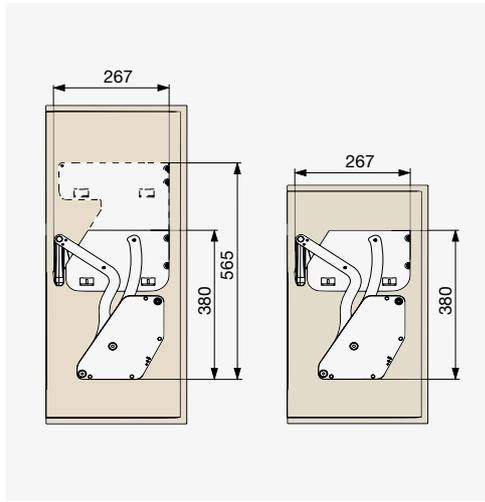

- Nosivost 8 kg
- Inteligentni sustav za spuštanje iz gornjih ormarića

## ● iMove Set



① F005450



① F005453



① F005451

- Sadržaj paketa:
- iMove košara
  - Navlake
  - Pričvrсни materijal
  - Predložak bušenja



① F005448



① F005452



① F005449

Širina ormarića [mm]	Broj košara	Antracit	Srebno	Širina [mm]	Visina [mm]	Dubina [mm]
600	1	F005450	F005448	565	380	267
	2	F005453	F005452	565	565	
900	1	F005451	F005449	865	380	

01  
02  
03  
04  
05  
06  
07  
08  
09  
10  
11  
12  
13  
14  
15  
16  
17  
18

# Kesseböhmer TurnMotion II

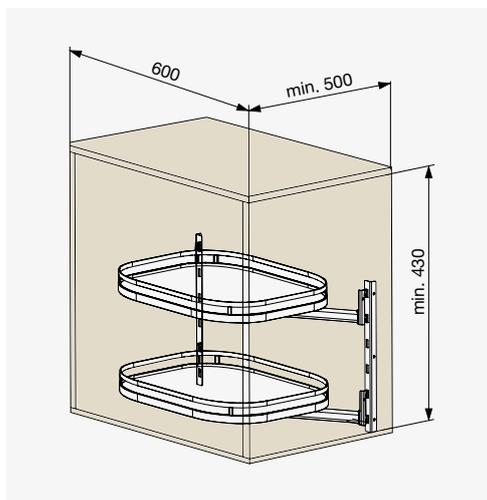

- Nosivost 20 kg
- Okretne košare
- Za širinu ormarića 600 mm

## ● TurnMotion II Set

10



① F005454



① F005455



① F005456

### Sadržaj paketa:

- 2 košare s podupiračima
- 2 montažne trake
- Pričvrtni vijci

Tip košare	Antracit	Bijela / krom	Širina [mm]	Visina [mm]	Dubina [mm]
ARENA čista	F005454	×	562	430	495
ARENA style	F005455	F005456			

# Riex

## Ocjeđivači posuđa

### ⊕ Riex GU16

#### Ocjeđivač posuđa

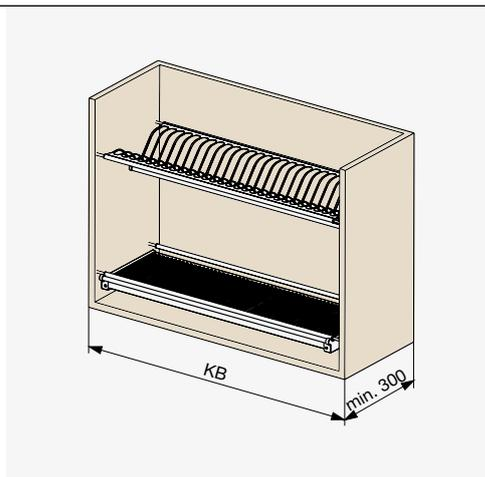

- Ocjeđivač posuđa za montiranje na gornji ormarić
- Materijal od nehrđajućeg čelika

Širina ormarića KB [mm]	Nehrdajući čelik	Dubina ormarića [mm]	Broj polica
500	F001221		
600	F001222		
700	F001223	min. 300	2
800	F001224		
900	F001225		

# Organizatori

10



# Kesseböhmer SpaceFlexx

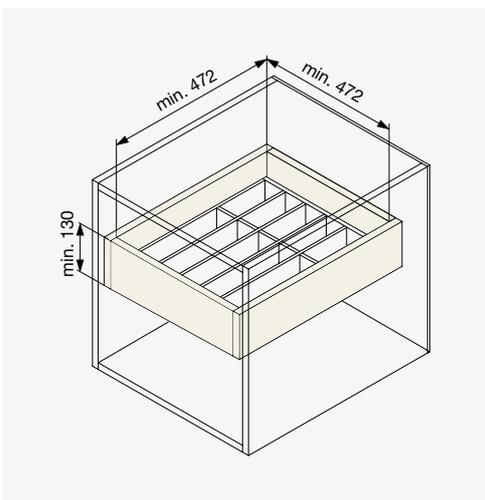

- nesttex® razdjelnik je baziran na specijalnom visokokvalitetnom tekstuilu
- nesttex® razdjelnik je periv u mašini za pranje suđa
- nesttex® dijeitelji su stroj za pranje

## ● SpaceFlexx Set



- Sadržaj paketa:
- 1 okvir
  - 5 fleksibilni nesttex® odjeljaka

© F005457

Krom	Širina [mm]	Visina [mm]	Dubina [mm]
F005457	472 / 520	min. 130	472

Space Flexx ima postavku širine 472 ili 520 mm za optimalnu prilagodbu.

01  
02  
03  
04  
05  
06  
07  
08  
09  
10  
11  
12  
13  
14  
15  
16  
17  
18

# Riex GI88

## Viseći sustav



10

### ⊕ Riex GI88

#### Zidni profil

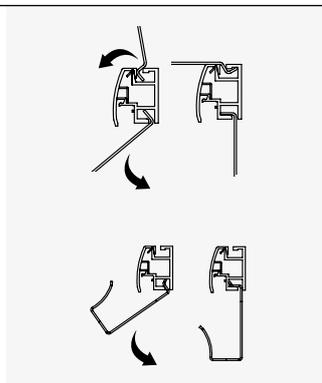

⊙ Instalacija dodatka

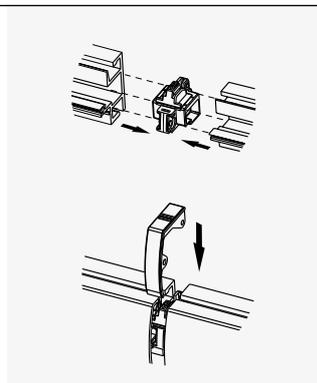

⊙ Povezivanje profila

- Alumijski profili
- Čelični dodaci
- Jednostavna instalacija dodatka profila
- Povezivanje profila zahvaljujući sofisticiranim konektorima

#### Sadržaj seta:

- 1 alumijski profil
- 2 završne kape
- 1 konektor
- 5 vijaka 4 x 35 mm
- 6 plastičnih vješalica

Dužina [mm]	Tamno sivo	Visina [mm]	Dubina [mm]	Materijal
600	F001030	40	30,9	Aluminij
900	F001031			
1200	F001032			



## ⊕ Riex GI88 Polica



⊕ F001033



⊕ F001034



⊕ F001035



⊕ F001036

Tip	Tamno sivo	Visina [mm]	Dubina [mm]	Širina [mm]	Materijal
Visna polica 105 mm	F001033	105			
Visna polica 155 mm	F001034	155	155	270	Čelik
Visna polica 260 mm	F001035	260			
Gornja polica	F001036	16,3	157		

## ⊕ Riex GI88 Vješalice



⊕ F001037



⊕ F001038



⊕ F001039

Tip	Tamno sive	Visina [mm]	Dubina [mm]	Širina [mm]	Materijal
Set od 3 male vješalice	F001037	49	25		
Set od 3 velike vješalice	F001039	69	38	16	Čelik
Vješalice set	F001038	49	25	246	

# Okovi za garderobu

Prostor u ormarima, ugradbenim ili samostojećim, može se vrlo namjenski opremiti elementima za odlaganje. Prikladno rješenje može biti elegantna tamno siva linija proizvoda robne marke Riex, koja nudi opsežan asortiman visokokvalitetnih proizvoda, uključujući sustave za pohranu odjeće, obuće i nakita. Međutim, ovo poglavlje također uključuje uobičajene proizvode kao što su žičane košare, pribor za odjeću i ostalo.



---

● Tamno siva serija	11.3
● Žičane košare na izvlačenje	11.9
● Vješalice na izvlačenje	11.11
● Okov za garderobu	11.13
● Stalci za cipele	11.17

---

# Tamno siva serija

11



## ⊕ Riex VX95

### Okvir s mrežastom košarom za pohranu na izvlačenje

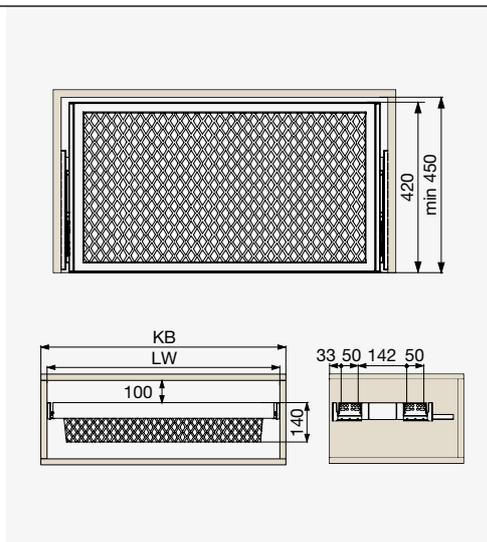

- Potpuno izvlačenje skrivenih vodilica s soft-close zatvaranjem
- Podešavanje širine 20 mm
- Aluminijski okvir
- Tamno siva boja

Širina KB [mm]	Kod	Širina LW [mm]	Visina [mm]	Dubina [mm]
600	F000569	564–584		
700	F000570	664–684		
800	F000571	764–784	140	420
900	F000572	864–884		

## ⊕ Riex VX85

### Okvir sa policom za cipele na izvlačenje

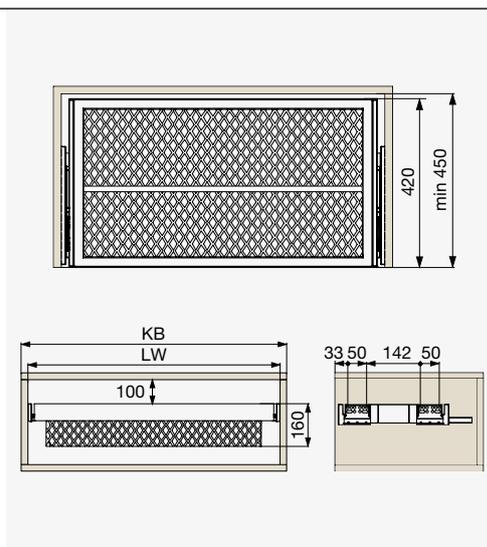

- Potpuno izvlačenje skrivenih vodilica s soft-close zatvaranjem
- Podešavanje širine 20 mm
- Aluminijski okvir
- Tamno siva boja

Širina ormara [mm]	Kod	Širina LW [mm]	Visina [mm]	Dubina [mm]
600	F000577	564–584		
700	F000578	664–684		
800	F000579	764–784	160	420
900	F000580	864–884		

## ⊖ Riex VX75 Okvir s policama za hlače na izvlačenje

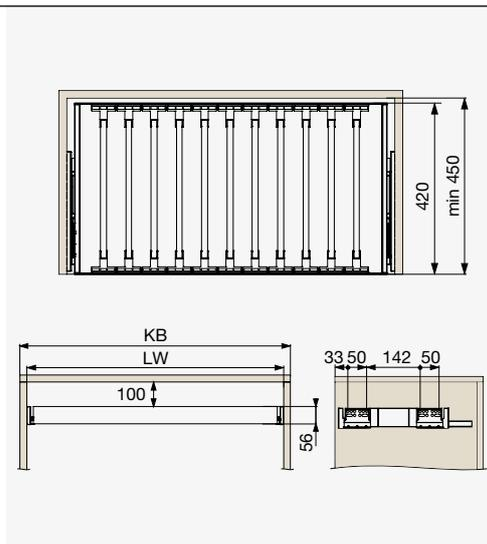

- Potpuno izvlačenje skrivenih vodilica s soft-close zatvaranjem
- Podešavanje širine 20 mm
- Aluminijски okvir
- Tamno siva boja
- Preporučena minimalna visina ormara je 700 mm

Širina ormara KB [mm]	Kod	Širina LW [mm]	Visina [mm]	Dubina [mm]
600	F000581	564–584	56	420
700	F000582	664–684		
800	F000583	764–784		
900	F000584	864–884		

## ⊖ Riex VX65 Okvir s kutijom za nakit na izvlačenje

11

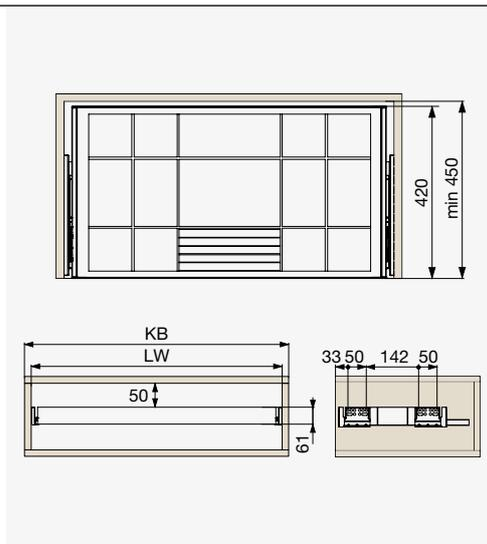

- Potpuno izvlačenje skrivenih vodilica s soft-close zatvaranjem
- Podešavanje širine 20 mm
- Aluminijски okvir
- Tamno siva boja

Širina ormara KB [mm]	Kod	Širina LW [mm]	Visina [mm]	Dubina [mm]
600	F000585	564–584	61	420
700	F000586	664–684		
800	F000587	764–784		
900	F000588	864–884		

## ● Riex VX27

### Stalak za vješalice na izvlačenje

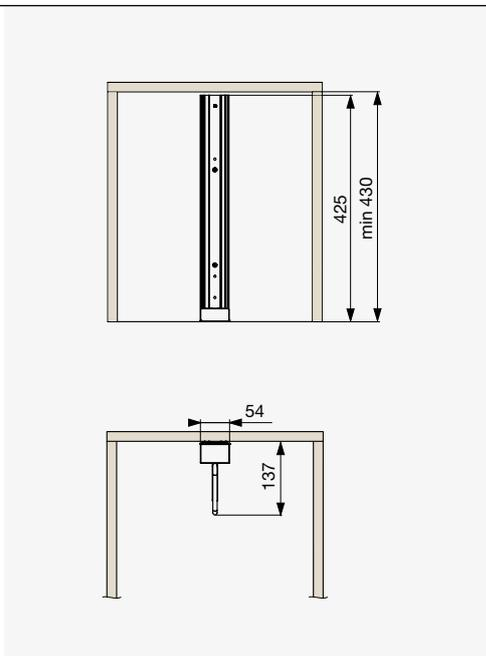

- Sustav soft-close zatvaranja
- Tamno siva boja
- Preporučena minimalna visina ormara je 1100 mm

Kod	Širina [mm]	Visina [mm]	Dubina [mm]
F000589	54	137	425

## ● Riex VX17

### Vješalica za hlače na izvlačenje

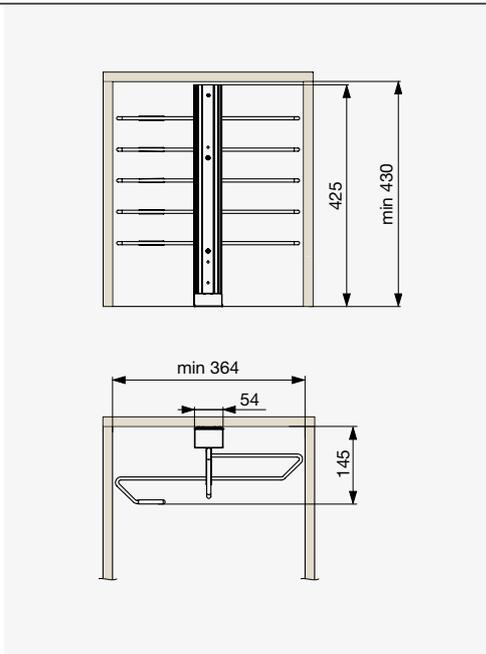

- Sustav laganog zatvaranja
- 5 vješalica
- Tamno siva boja
- Preporučena minimalna visina ormara je 700 mm

Kod	Širina [mm]	Visina [mm]	Dubina [mm]
F000590	350	145	425

01  
02  
03  
04  
05  
06  
07  
08  
09  
10  
11  
12  
13  
14  
15  
16  
17  
18

## ⊕ Riex VX47 Šipka za garderobu na spužtanje

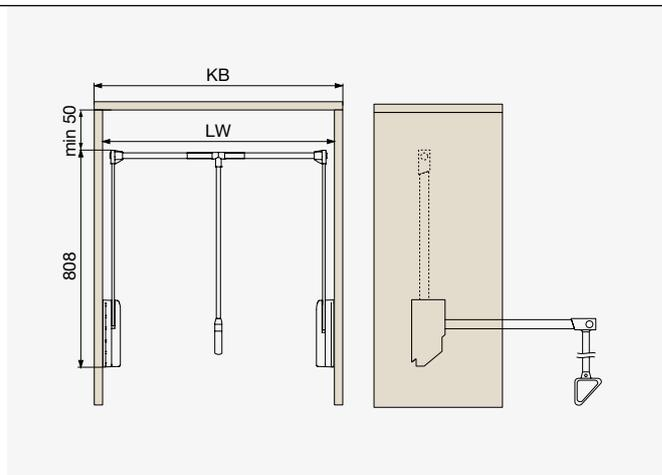

- Nosivost 25 kg
- Gornje i donje soft-close zatvaranje
- Podešavanje širine 200 mm
- Tamno siva boja

11

Širina ormara KB [mm]	Kod	Širina LW [mm]	Visina [mm]	Dubina [mm]
600–800	F000594	564–764	808	140
800–1000	F000595	764–964		

## ⊕ Riex VX34 Četvrtasta šipka za ormar

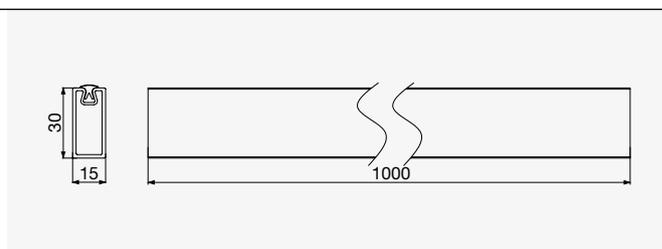

- Aluminijska šipka
- Tamno siva boja

Duljina [mm]	Kod	Širina [mm]	Visina [mm]
1000	F000596	15	30



## ● Riex VX34 Držać šipke za ormar

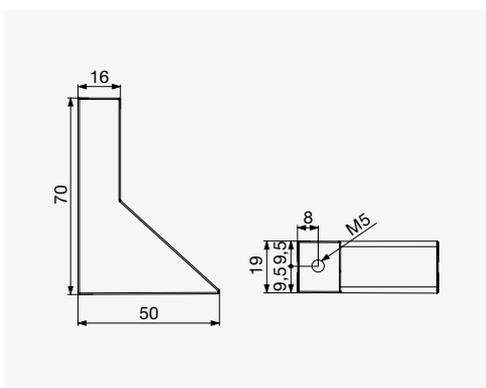
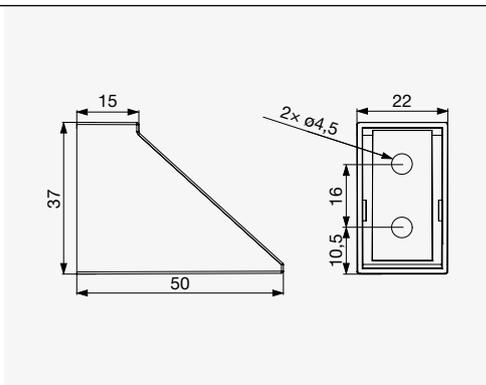

Montaža	Kod
Bočna	F000597
Pod, ispod police	F000598

## ● Riex VX53 Rotirajući stalak za cipele

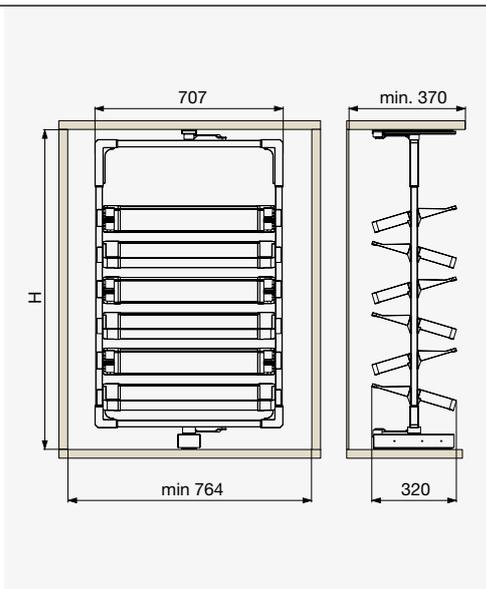

- 180° rotacioni sustav štedi prostor
- Podešavanje visine 100 mm
- Stalac za cipele se sastoji od okvira i police
- Uvijek je potrebno naručiti oba artikla
- Srebro okvir i smeđe police

Okvir s mehanizmima		Set od police	
Visina H [mm]	Kod	Kod	Br. od police
1155-1255	F000591	F002928	6
1425-1525	F000592	F002929	8
1695-1795	F000593	F002930	10

# Mrežasta košara na izvlačenje

## ⊕ Riex VB66 Mrežasta košara



○ Bijela

● Tamno siva

- Klizači s valjcima moraju se kupiti zasebno
- Klizači na str. 11.10

Širina ormara KB [mm]	Bijela	Tamna siva	Širina W [mm]	Visina [mm]	Dubina [mm]
400	F000939	F000943	336	160	494
500	F000940	F000944	436		
600	F000941	F000945	536		
800	F000942	F000946	736		

## ⊕ Riex VB63 Žičana košara

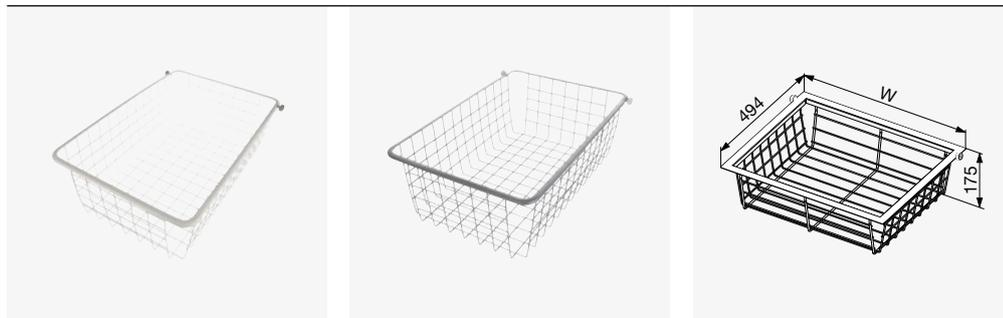

○ Bijela

● Tamno siva

- Klizači s valjcima moraju se kupiti zasebno
- Klizači na str. 11.10

Širina ormara KB [mm]	Bijela	Tamna siva	Širina W [mm]	Visina [mm]	Dubina [mm]
400	F001040	F001044	336	175	494
500	F001041	F001045	436		
600	F001042	F001046	536		
800	F001043	F001047	736		

## ● Riex VB63 / VB66

### Klizač za košaru za garderobu



○ Bijela

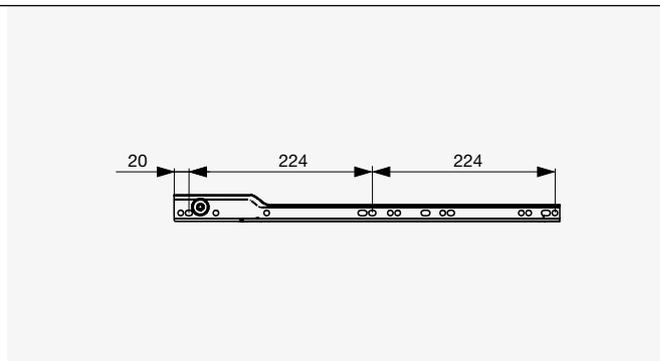

● Tamno siva

- Klizači kompatibilni s košarama VB63 i VB66

Debljina ploče [mm]	Bijela	Tamno siva	Length [mm]
16	F000947	F000949	472
18-19	F000948	F000950	

# Vješalice na izvlačenje

## ⊕ Riex VH21 Izvlačni stalak za vješalice, krom

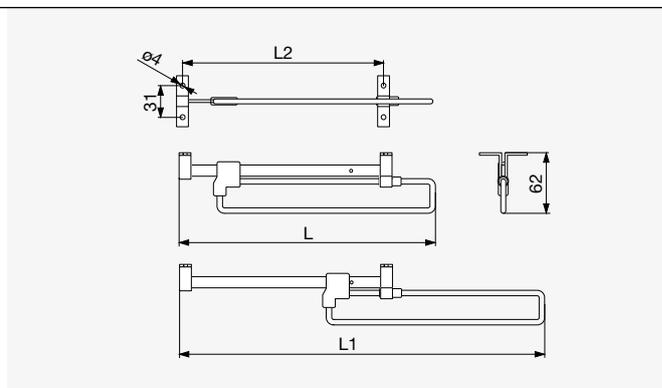

Duljina L [mm]	Kod	Duljina L1 [mm]	Duljina L2 [mm]
250	F000822	390	225
300	F000823	490	276
350	F000824	590	326
400	F000825	690	376
450	F000826	790	424
500	F000827	890	474

## ⊕ Riex VH11 Vješalica za hlače na izvlačenje, krom

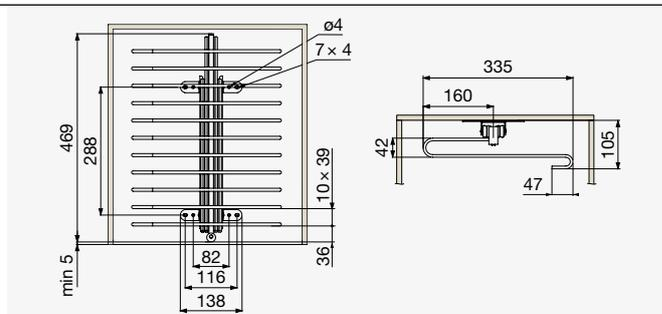

Broj od vješalice	Kod
11	F001200

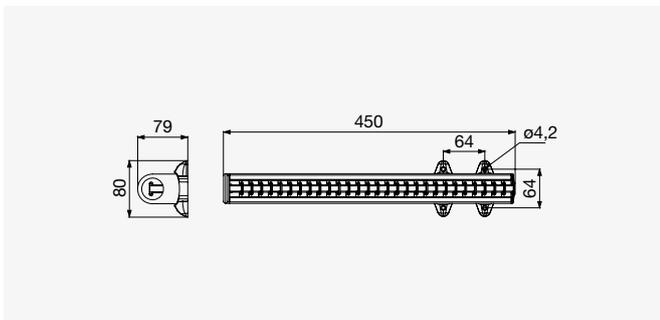
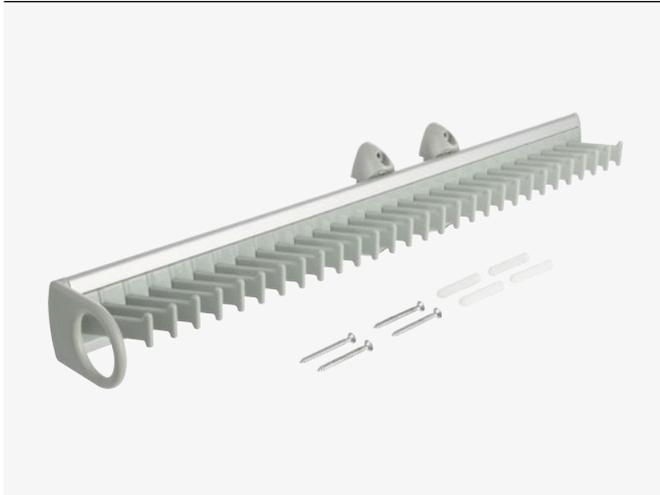
**● Riex VH31****Vješalica za kravatu / pojas, svijetlo siva na izvlačenje**

Broj kuka

Kod

29

F001798

# Šipke za garderobu

## ● Riex VT43

### Šipka za garderobu na spužtanje



○ Bijelo



● Anodizirani aluminij / srebro

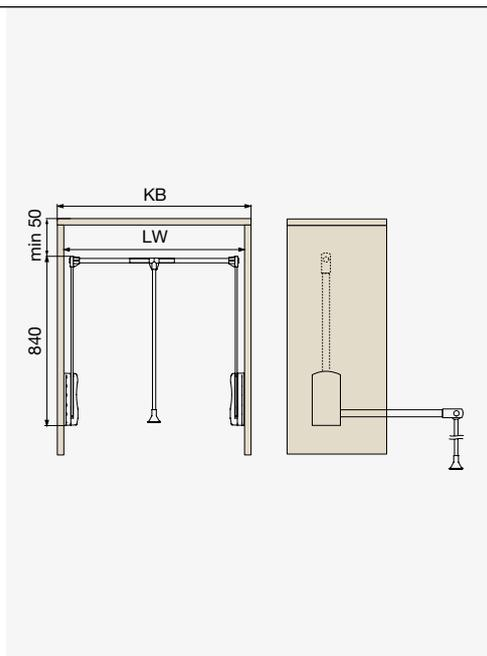

• Nosivost 10 kg

Širina ormara KB [mm]	Bijelo	Eloksiran aluminij / srebro	Širina LW [mm]	Visina [mm]	Dubina [mm]
726-956	F000834	F000835	690-920	840	150
956-1276	F000836	F000837	920-1240		

## ● Riex VT14

### Garderobni šank, ovalni, 30 × 15 mm

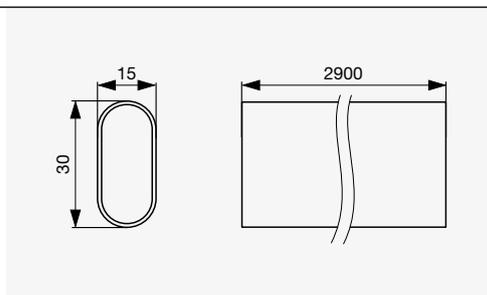

Boja	Kod	Debljina [mm]	Duljina [mm]	Materijal
Anodizirani aluminij	F002769	1,1	2900	Aluminij

## ● Riex VT24

### Ovalna ormar šipka, 30 × 15 mm

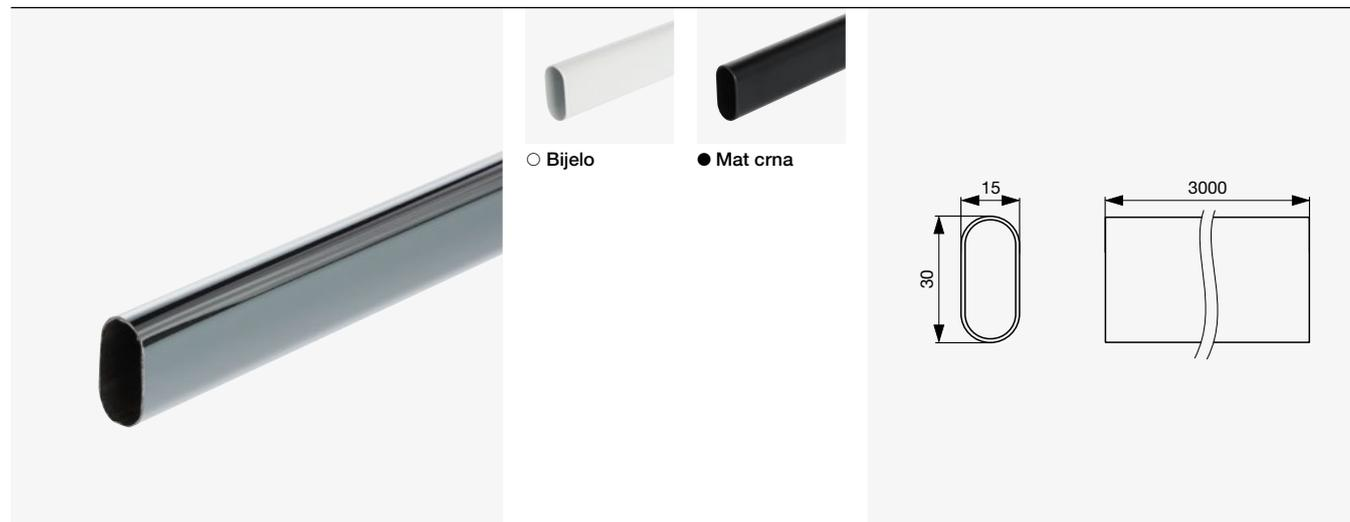

● Krom

Boja	Debljina [mm]	Kod	Duljina [mm]	Materijal
Krom	0,7	F001096	3000	Čelik
Bijela		F001097		
Krom	1,0	F001099		
Mat crna		F001100		

## ● Riex VT24 / VT14

### Držač ovalne šipke, 30 × 15 mm

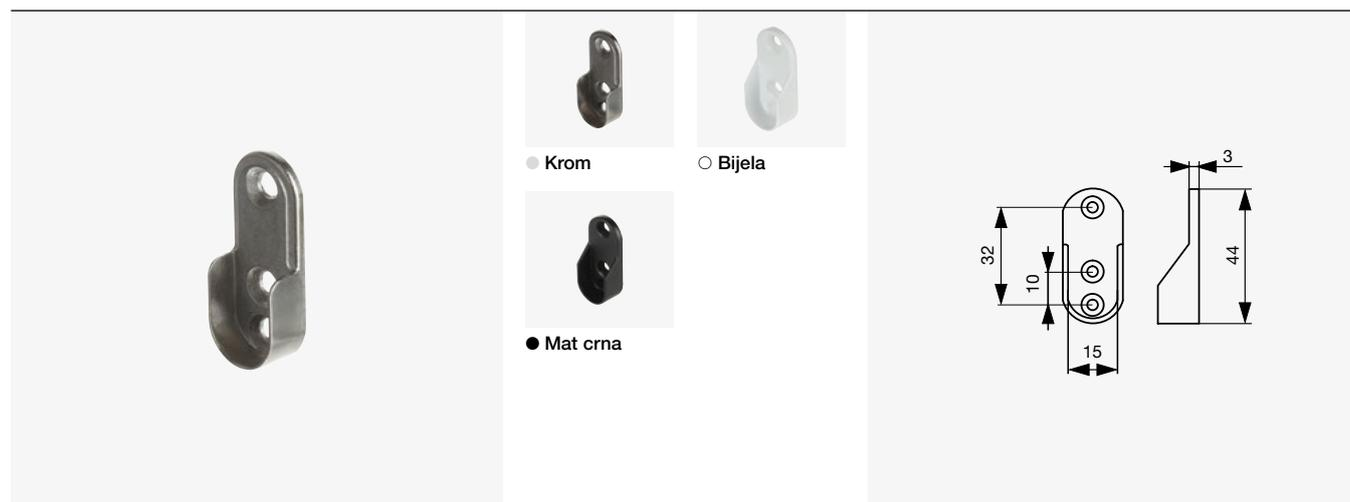

● Nikal

Boje	Kod	Materijal	Montaža
Nikal	F001117	Čelik	Strana
Nikal	F001118		
Krom	F001119	Cinkov	
Bijela	F001120		
Mat crna	F001121		

**⊕ Riex VT24 / VT14**  
**Držać ovalne šipke, 2 klina, 30 × 15 mm**



Boje	Kod	Materijal	Montaža
Krom	F001122	Cink	Strana s klinovima

**⊕ Riex VT24 / VT14**  
**Držać ovalne šipke, zavrtnje ispod police, 30 × 15 mm**



Boje	Kod	Materijal	Montaža
● Krom	F001123	Cink	Ispod police
● Mat crna	F001124		

**⊕ Riex VT24 / VT14**  
**Ovalni držać šipke, 30 × 15 mm**



Boja	Montaža	Kod	Materijal
Nikal	Sredina	F001125	Cink
	Kraj	F001127	

11



### ⊕ Riex VT23

#### Okrugla šipka za ormar, promjer 25 mm

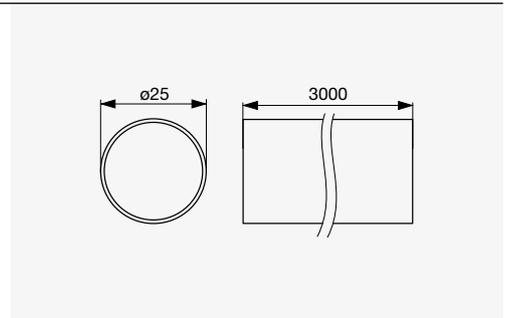

Boje	Debljina [mm]	Kod	Duljina [mm]	Materijal
Krom	0,7	F004988	3000	Čelik
	1	F004989		

### ⊕ Riex VT23

#### Držać okrugle šipke, promjer 25 mm

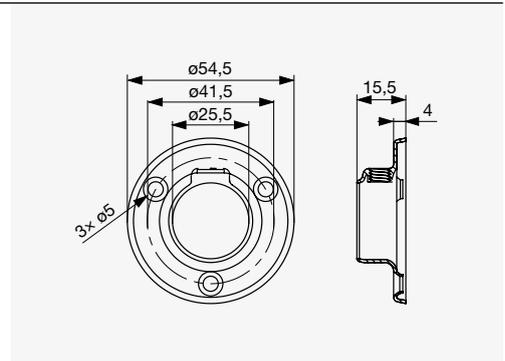

Boje	Kod	Materijal	Montaža
Krom	F005026	Čelik	Bočna

# Stalci za cipele



11

## ➤ Riex VS33 Stalac za cipele, krom / crna

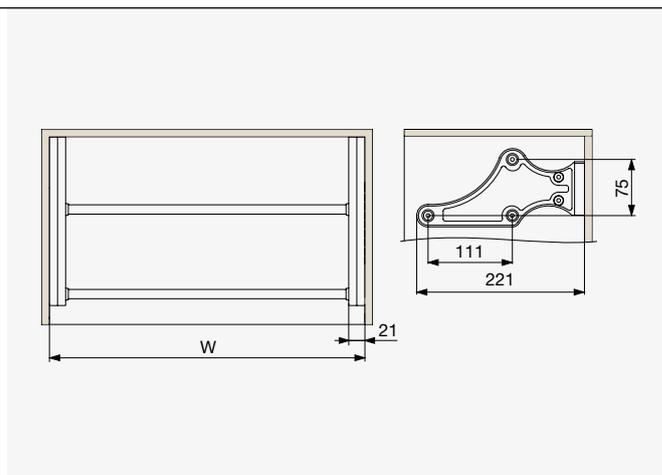

Širina W [mm]	Kod	Boja
400-700	F000831	Krom / crno
700-1100	F000832	

## ● Riex VS13 Nagibni stalak za cipele, bijela

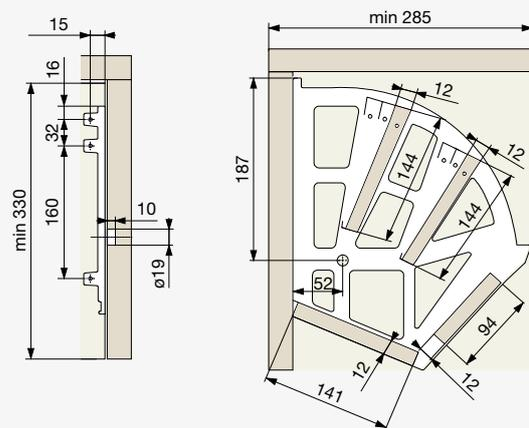
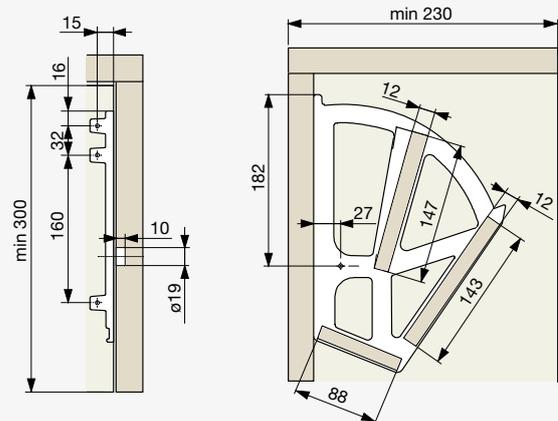
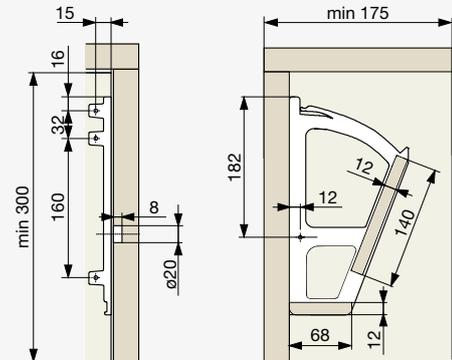

Broj od polica

Kod

Boja

1

F000828

2

F000829

3

F000830

Bijela

# Okovi za klizna vrata

Prednost kliznih sustava je iskoristivost prostora. Nema potrebe ostavljati prostor ispred ormara ili unutra za otvaranje vrata. U ovom odjeljku pronaći ćete mnoge sustave za različite vrste ormara, a možete birati između širokog spektra sustava s gornjim ili donjim vođenjem. Poseban dio posvećen je sustavima za unutarnja vrata, kod kojih je gotovo uvijek poželjno tiho zatvaranje s prigušivanjem, što većina sustava naravno ispunjava. Također u ovom odjeljku možete odabrati proizvode različitih marki kao što su Riex, Hawa, Cinetto, Sisco.



● Klizna vrata za namještaj – gornja vodilica	12.3
Cinetto PS40	12.5
Riex ES80	12.9
Riex ES70	12.11
Hawa Clipo	12.13
Riex ES45	12.15
● Sklopiva vrata za namještaj – gornja vodilica	12.17
Cinetto PS23	12.17
● Okretna i sklopiva džepna vrata u ravnini	12.19
Hawa Concepta	12.21
Hawa Folding Concepta	12.23
● Klizna vrata za namještaj – donja vodilica	12.25
Riex ES40	12.26
Riex ES65	12.27
Hawa Combino [Kombinacija]	12.29
Riex ES44	12.31
● Okovi za ravnanje	12.33
● Unutarnja vrata	12.35
Cisco Skriven	12.37
Cinetto PS66	12.39
Hawa Junior	12.41
Riex ES25	12.47

# Klizna vrata za namještaj – gornja vodilica

- Skrivene šine, vrata od poda do stropa su prednosti sustava s gornjom vodilicom
- Ovaj sustav zahtijeva čvrstu konstrukciju stropa kako bi se izbjeglo popuštanje vodilica. Naime visoka vrata zahtijevaju pojačanje kako bi se spriječilo uvijanje vrata



# Približna težina materijala

- Na temelju podataka proizvođača, mogu se razlikovati u različitim zemljama
- Težina vrata mora biti u skladu s nosivošću kliznog sustava
- Približni podaci, za biranje ispravnog spajanja, posebno u kompliciranim instalacijama predlažemo provjeriti težinu fizički i dobiti ispravne podatke

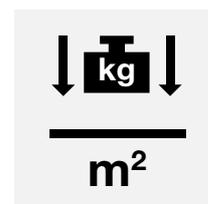

## ● Iverica

Debljina [mm]	Težina [kg / m <sup>2</sup> ]
8	5–6
10	6–8
12	7–9
16	10–11
18	11–12
19	15–18
22	13–17
25	15–19
28	16–20
38	20–25

## ● MDF

Debljina [mm]	Težina [kg / m <sup>2</sup> ]
10	6–8
18	12–14
25	17–19
28	19–21

## ● HPL

Debljina [mm]	Težina [kg / m <sup>2</sup> ]
8	10–11
10	14–15
12	15–18

## ● Saćasta ploča

Debljina [mm]	Težina [kg / m <sup>2</sup> ]
38	11–12
50	11–12

## ● Puno drvo

Za ddebljinu 40 [mm]	Težina [kg / m <sup>2</sup> ]
Bukva	25–29
hrast	24–30
Smreka / Bor	18–19
Ariš	22–24

- Težina ovisi o prirodnom stanju, gustoći drva, vrijedi za relativnu vlažnost cca 8%

## ● Staklo

Debljina [mm]	Težina [kg / m <sup>2</sup> ]
4	10
5	12,5
6	15
8	20
10	25
12	30

# Cinetto PS40

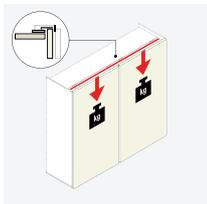

- Klizni sustav s komplanarnim vratima
- S obzirom na nosivost od 60 kg po vratima, moguće je i električno upravljanje vratima
- Širina 890–1800 mm, visina maks. 3000 mm
- Preporučuje se upotreba ispravljača kod visokih vrata

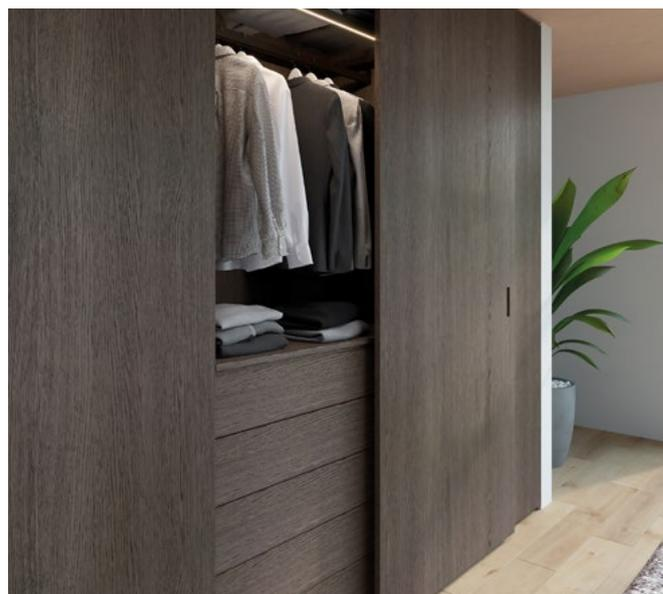

Video instalacija :



## ● Cinetto PS40 Koplanarni klizni sustav

12

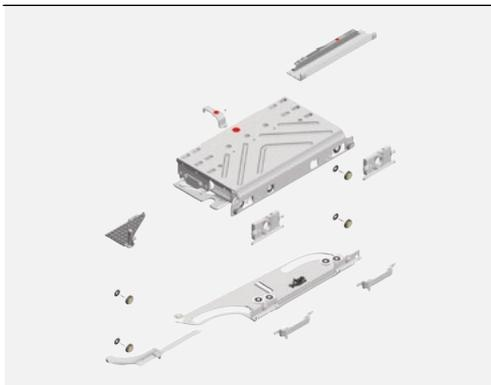

① F004805 Set za lijevo vrata

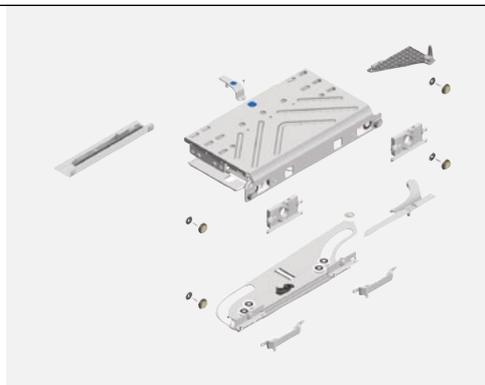

② F004806 Set za desna vrata

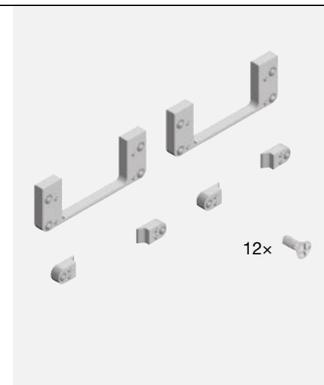

③ F004807 Montaža adaptera

- Okovi za lijeva i desna vrata mora se posebno naručiti
- Montaža adaptera je potrebna za površinsku montažu [bez glodanja]

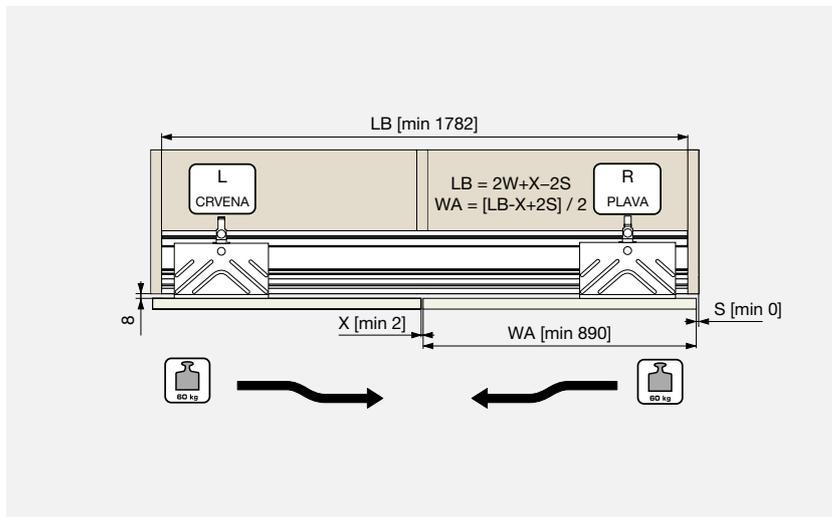

Tip	Kod
Lijevo vrata [set]	F004805
Pravo vrata [set]	F004806
Površinski adapteri [set]*	F004807

\* Za svaka vrata je potrebno naručiti jedan set.



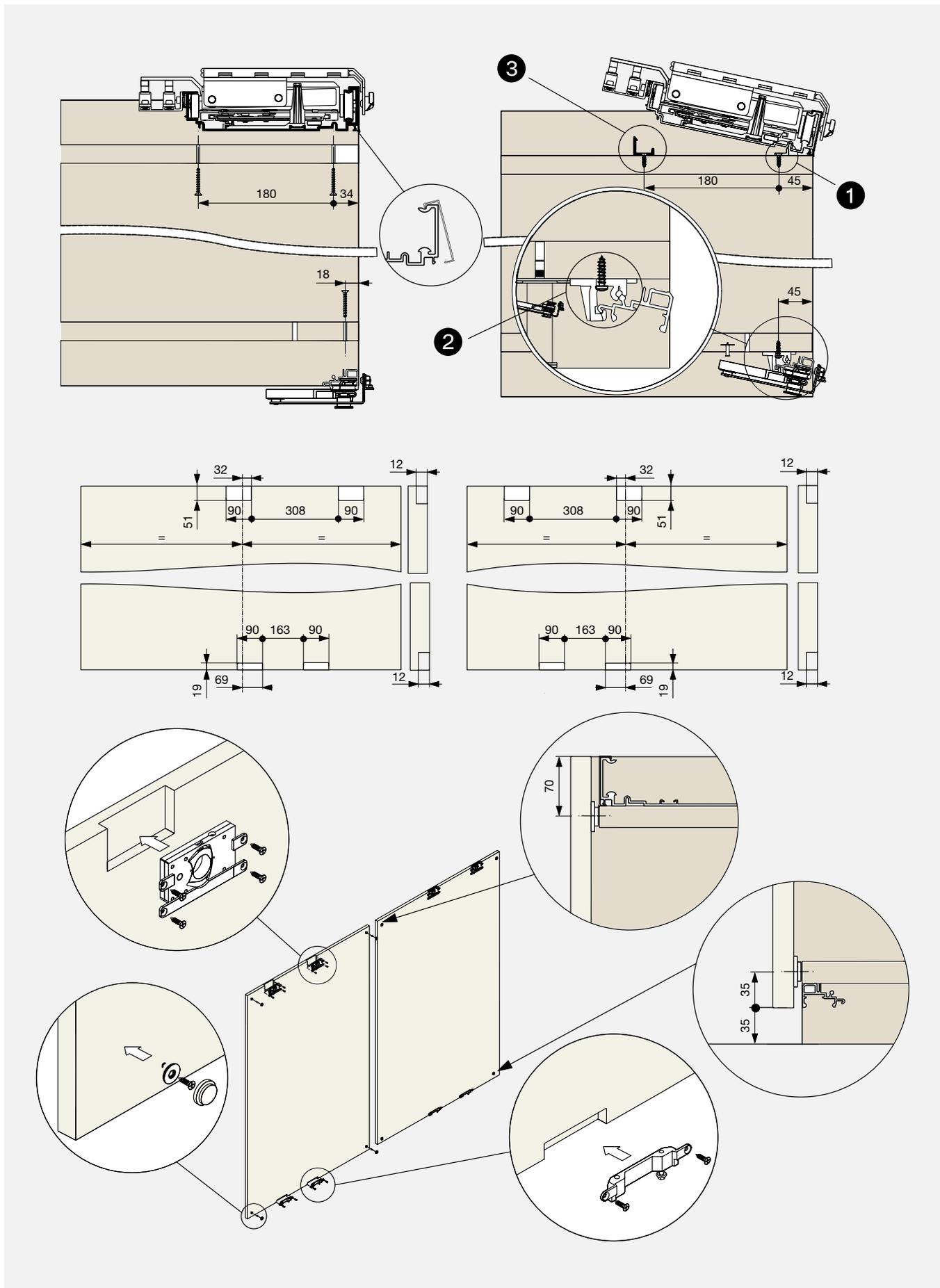

## ● Cinetto PS40 Šine

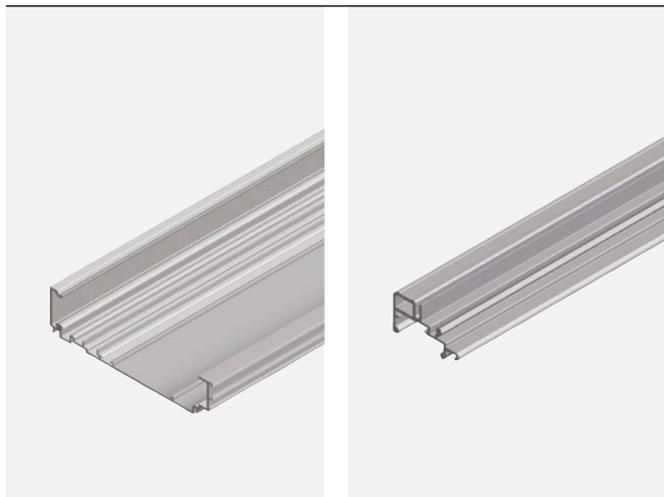

① F004809

① F004812

- Elokirano brušeno srebro

Duljina [mm]	Gornja vodilica	Donja vodilica
2000	F004809	F004812
3000	F004810	F004813
3850	F004811	F004814

## ● Cinetto PS40 Profil pokrova

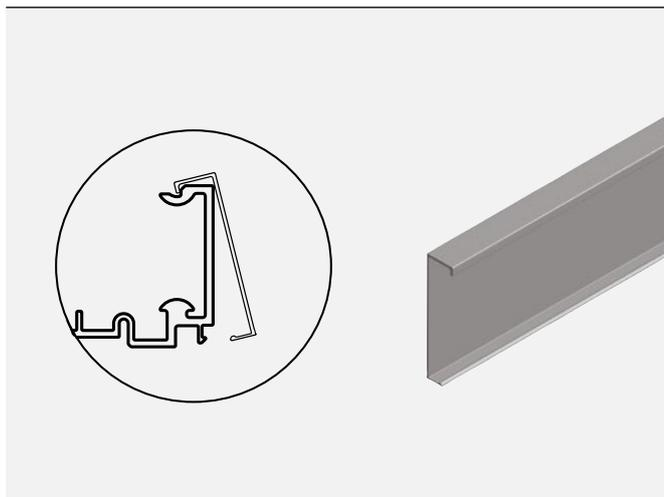

- Elokirano brušeno srebro
- Pogledajte crtež str. 12.6

Duljina [mm]	Kod
2000	F004808

## ● Cinetto PS40 Brza montaža

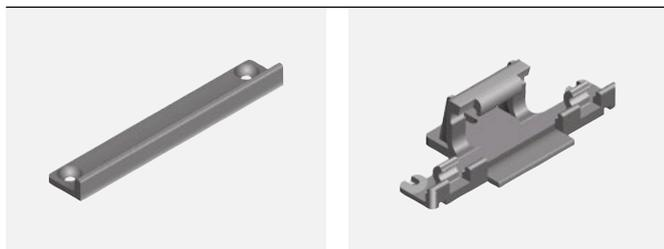

① F004815

① F004817

- Spojnice za bržu montažu, osiguravaju položaj vodilice
- Nije obavezno, preporučeno za pred-instalaciju, 2 kom od svakog tipa
- Pogledajte crtež str. 12.6



① F004816

Tip	Kod
Gornji spojnica za vodilice – prednja	F004815
Gornja spojnica vodilice – stražnja	F004816
Donja spojnica vodilice	F004817

## ● Cinetto PS40 B-Pokretna vrata s Električnim Otvaranjem

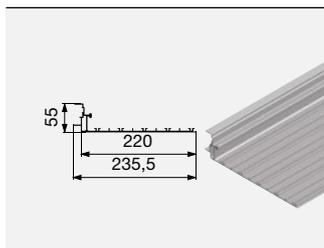

① F004818

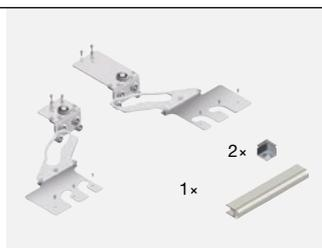

② F004819

- B-Pomični Električni sustav za otvaranje i zatvaranje
- Standardnoj verziji potreban je dodirni puls za otvaranje / zatvaranje vrata ili korištenje priloženog daljinskog upravljača

### Za funkcionalni set potrebno je naručiti:

- Gornji profil [1x] + zgrade [1x] + linearni motori [2x] + upravljanje jedinicom [1x]
- Odvojeni linearni motor, koji se ovisno o širini vrata zasebno naručuje za svaka vrata
- Mogu se naknadno proširiti uz pomoć bezkontaktnog senzora zamahom



③ F004820



④ F004822

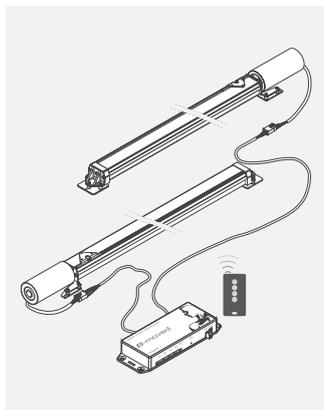

Linearno motor povezan s upravljačkom jedinicom

	Tip	Kod
①	Gornji profil 3000 mm	F004818
②	Set od zgrade	F004819
③	Linearni motor, vrata širina 888–1296 [prikaz, stručni]. mm	F004820
	Linearno motor, vrata širina 1154–1800 mm	F004821
④	Upravljanje elektroničke jedinice pomoću daljinskog upravljača	F004822

## ● Proširenje senzora zamaha Cinetto PS40



① F004823



② F004825

- Poboljšanje B pomične jedinice vrata s električnim upravljanjem funkcijom bez dodira
- Otvaranje zamahom ispred senzora
- Senzor zamaha može se postaviti do 10 m od prijemnika
- Bežična veza omogućuje instalaciju izvan ormara
- Senzor zamaha radi kroz materijal debljine najviše 10 mm, osim metalnog ili vodljivog materijala kao što je ogledalo
- Kabel s konektorom namijenjen je za spajanje kontrolera B-pomične jedinice [F004822] s vanjskim prekidačem [Smart home switch device]. Za otvaranje / zatvaranje vrata potreban je puls od oko 0,5 sekundi.



③ F004824

	Tip	Kod
	Prijemna jedinica za senzor zamaha	F004823
	Senzor zamaha s priborom za montažu	F004825
	Kabel za pomoćni upravljački ulaz	F004824

# Riex ES80

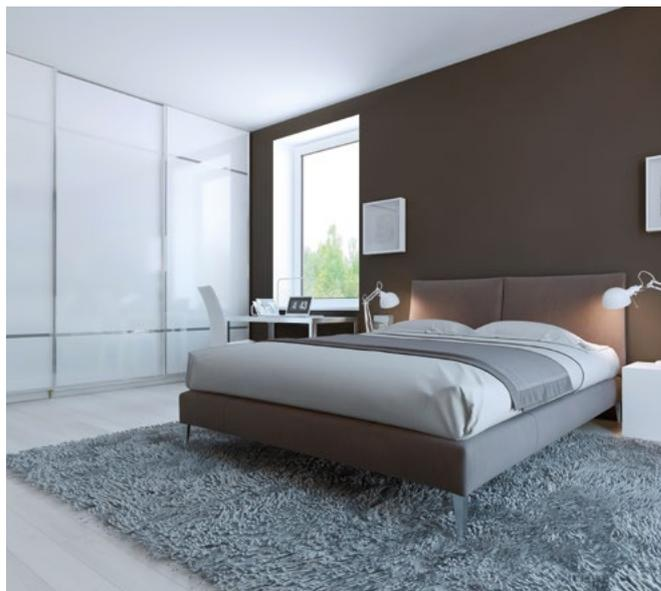
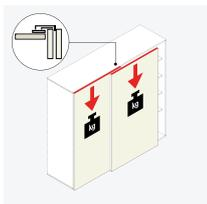

- Visoka kvaliteta preklapanja kliznog sustava
- Provjereno za 60 000 ciklusa
- Sustav za garderobe, veći ormar s kliznim vratima
- Skriveno vodilice [kada su zatvorene]
- Potpuno lagano zatvaranje
- 8 kom amortizera [gore i dolje] dozvoljava i suženje vrata
- Glatka i tiha funkcija
- Jednostavna instalacija, uključuje predložak
- Nosivost 80 kg po vratima

## ⊕ Riex ES80 Preklopni klizni sustav

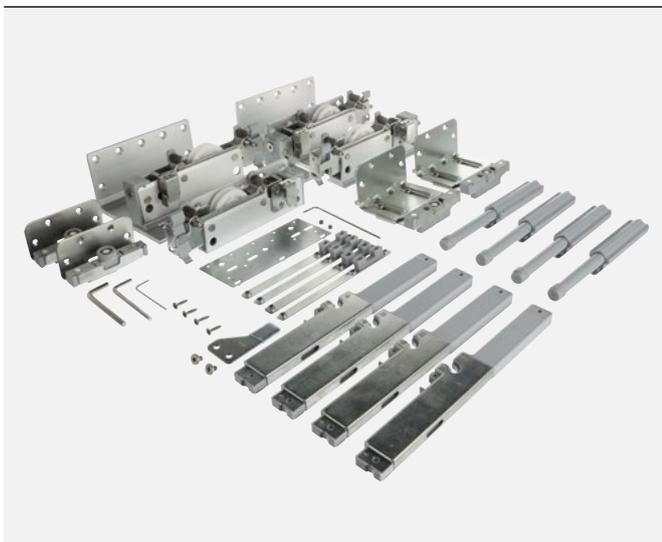

- Set okova
- Za Garnitura 3 vrata preporučujemo da dodajte srednji prigušivač

Set	Kod
2 vrata	F003335
3 vrata	F003336

⊕ Okovi [2 vrata verzija]

## ⊕ Riex ES80 Središnji amortizer sa zaštitom od sudara



- komplet s 3 vrata
- Centralni prigušivač drži vrata u srednjem položaju
- Otvaranje na obje strane
- Sustav protiv sudara štiti vrata na istoj tračnici od sudara, pomaže kod djelomičnog otvaranja bez sudara

Tip	Kod
Srednji amortizer	F003337

## ⊕ Riex ES80 Set gornje i donje šine

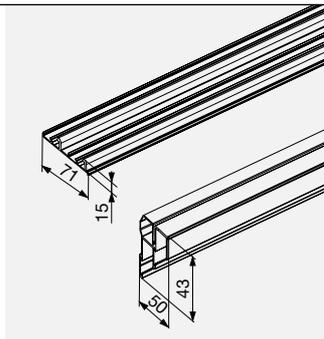

- Eloksirano srebro
- Jedan kod uključuje gornji i donji profil

Duljina [mm]	Kod
2000	F003338
3000	F003339
4000	F003340

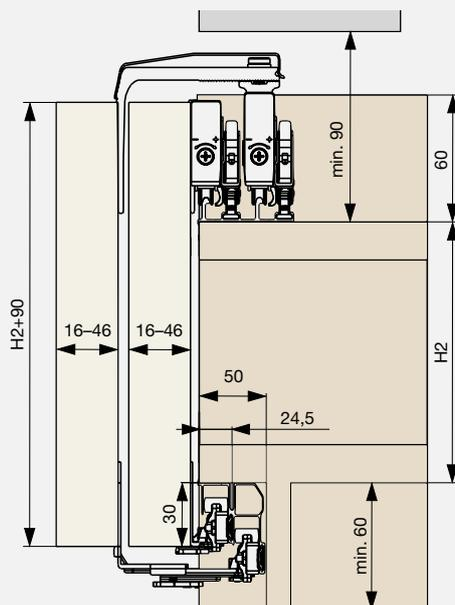
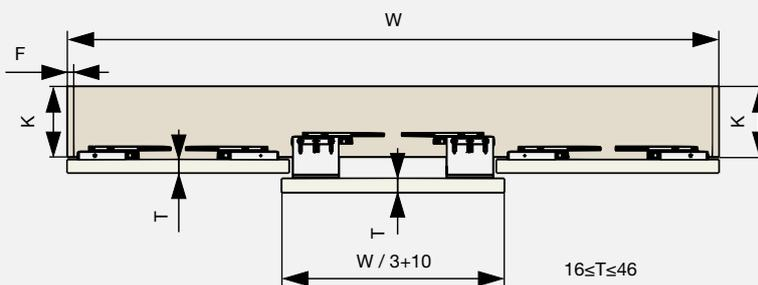
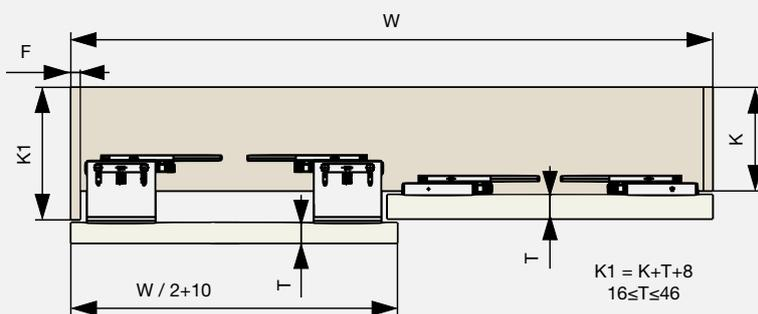

01  
02  
03  
04  
05  
06  
07  
08  
09  
10  
11  
12  
13  
14  
15  
16  
17  
18

# Riex ES70

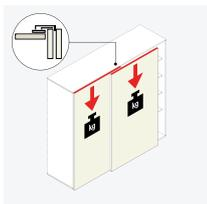

- Preklopni klizni sustav
- Sustav za garderobu, kabinet s kliznim vratima
- Skrivene vodilice [kada su zatvorene]
- Dostupno soft-close zatvaranje
- Nosivost 50 kg po vratima

## ⊕ Riex ES70 Preklopni klizni sustav

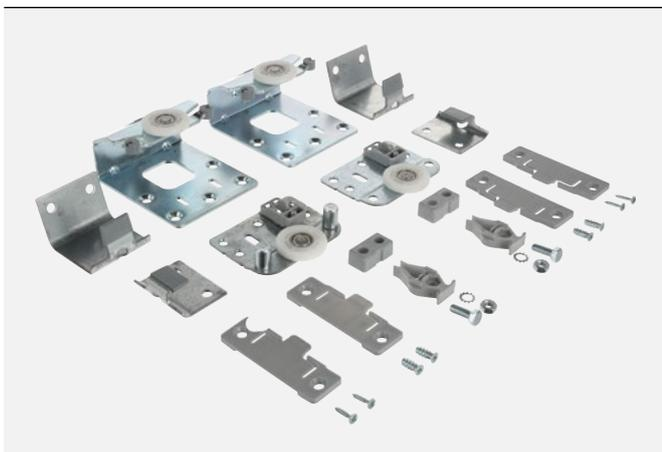

⊕ Okovi [2 vrata verzija]



⊕ Set sa soft-close zatvaranjem [2 vrata verzija]

Set za	Set okova [bez soft-close zatvaranja]	Soft-close mehanizam [set]*
2 vrata	F003406	F003408
3 vrata	F003407	F003409

\* Set uključuje amortizere za jednostrano prigušivanje [2 kom za 2 vrata i 3 kom za 3 vrata].

## ⊕ Riex ES70 šine



⊕ Gornja vodilica

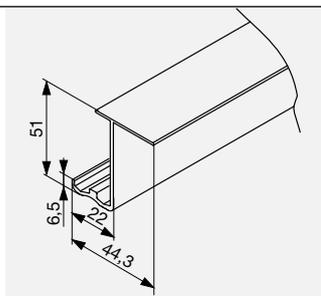

⊕ Donja vodilica

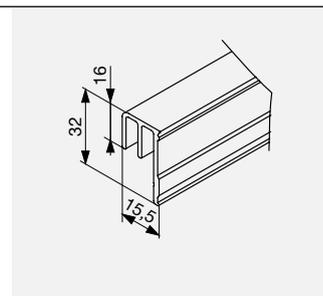

Duljina [mm]	Gornja vodilica	Donja vodilica
2000	F003410	F003412
3000	F003411	F003413

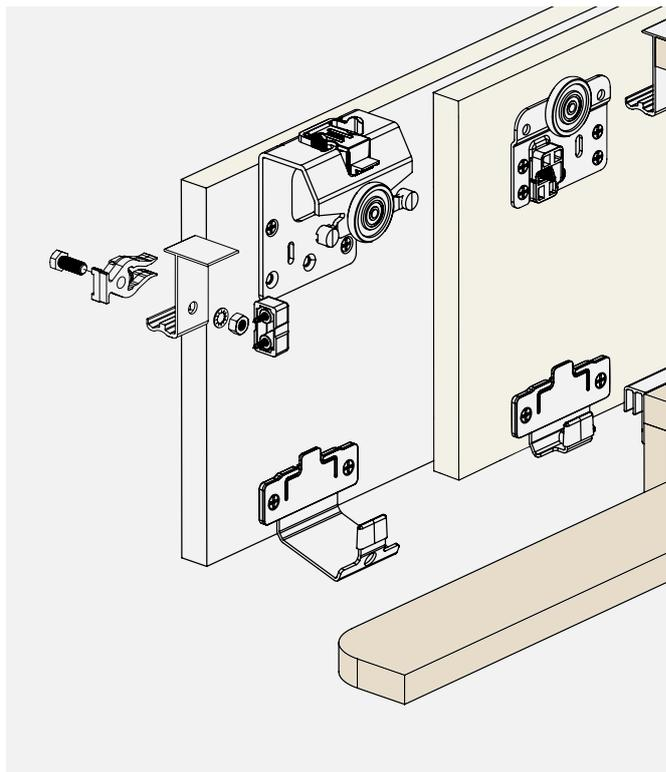
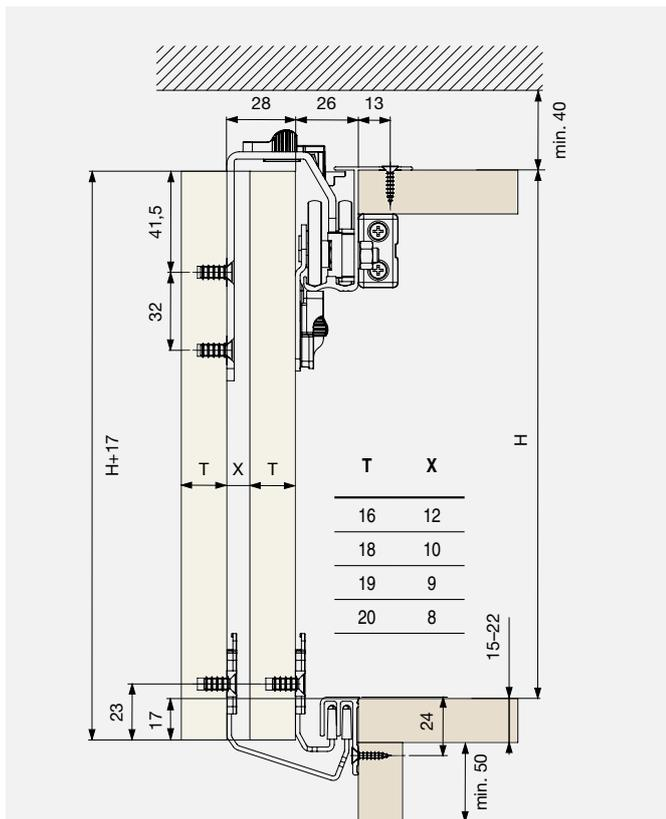

① Bez soft-close zatvaranja

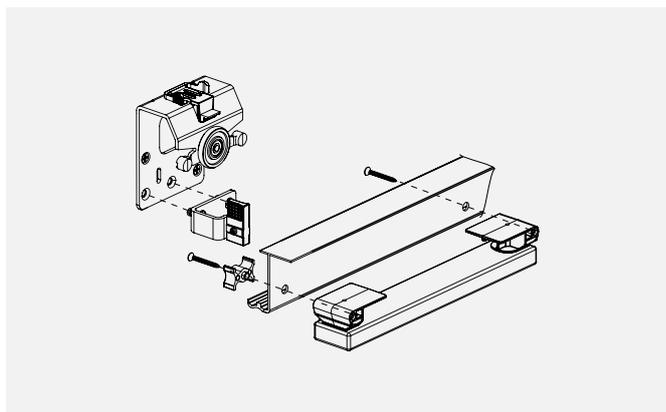
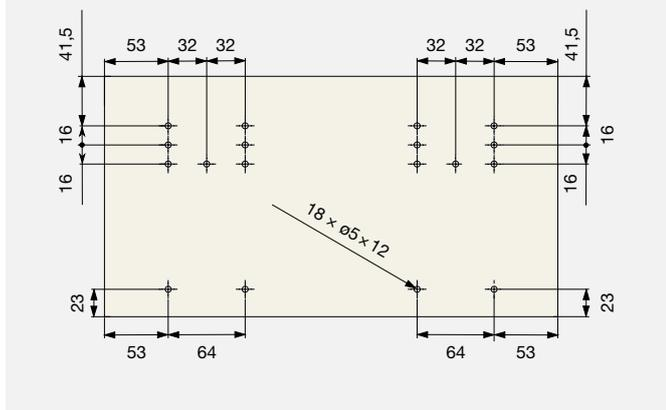

② Soft-close zatvaranje

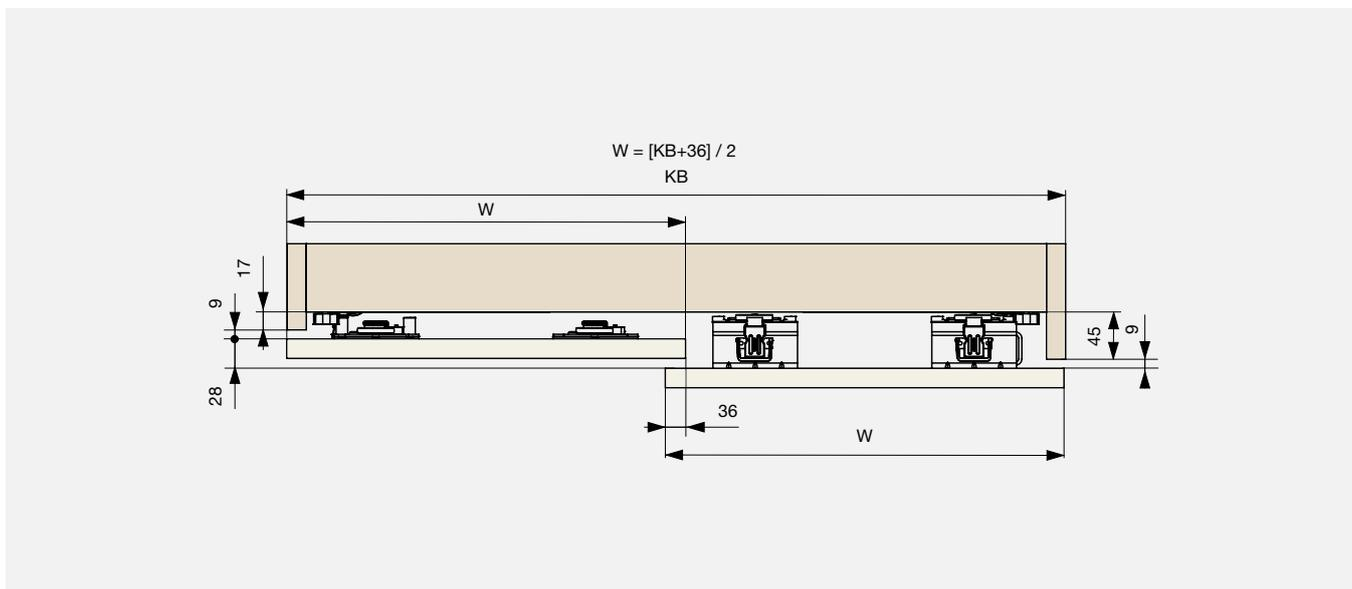

01  
02  
03  
04  
05  
06  
07  
08  
09  
10  
11  
12  
13  
14  
15  
16  
17  
18

# Hawa Clipo

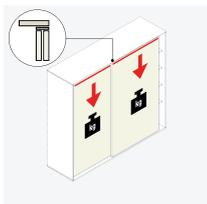

- Okov za gornja drvena vrata
- Nosivost 36 kg po vratima
- Staza za kretanje montirana u utore

## ● Hawa Clipo 36 H IS

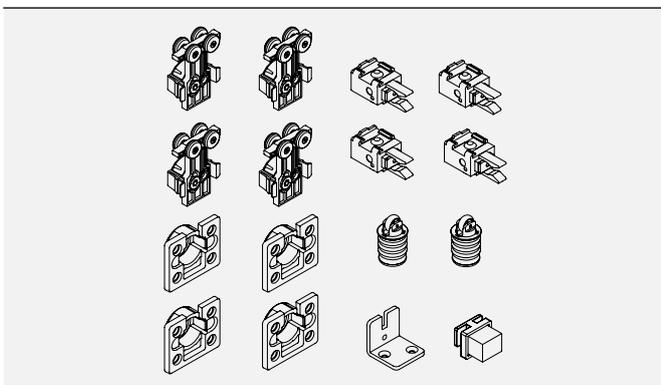

Ⓢ Okovi [2 vrata verzija]

- Set okova bez soft-close -a

Set	Kod
2 vrata	F004762
3 vrata	F004763

## ● Hawa Clipo 36 H IS Soft-Close

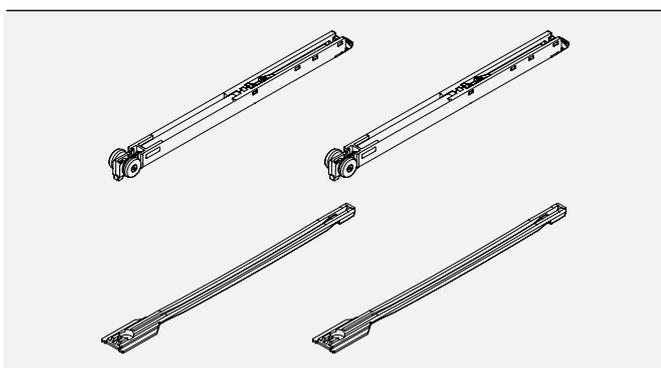

- Set sastoji se 2 kom [1 bočno prigušenije]

- Minimum širina vrata:**
- 1 bočno prigušenije 420 mm
  - 2 strane prigušenija 620 mm

Soft-close za težinu [kg]	Kod
15	F004764
26	F004765
40	F004766

## ● Hawa Clipo 36 H IS Vodilice

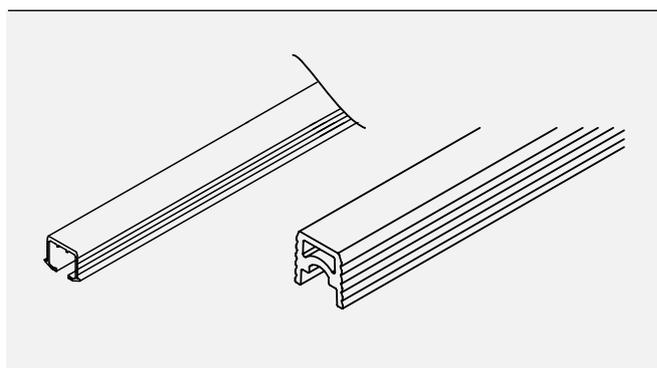

- Srebrno eloksiran [gornja vodilica]
  - Sivo plastični [Dno profil]
  - Fiksiranje ljepljivom
- Preporučeno ljepilo:**
- Hranipur 05
  - Hranipur SPEED

Duljina [mm]	Gornja vodilica	Dno profil
2500	F004767	F005574
3500	F004768	F005575





# Riex ES45

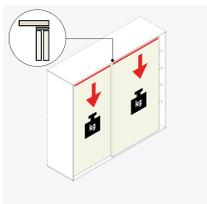

- Sustav za manji ormarić
- Potpuno soft-close zatvaranje
- Glatka i tiha funkcija
- Nosivost 15 kg po vratima

## ⊕ Riex ES45 Klizni sustav za drvena / staklena vrata



- Set uključuje okov za 1 vrata s 2 amortizera
- Prigušivači su instalirani u vodilica [skriveno]
- Minimalna širina vrata 520 mm



⊕ Set za stakla vrata

Materijal od vrata	Kod
Drvo	F003359
Staklo [5 mm]	F003360

⊕ Set za drveni vrata

## ⊕ Riex ES45 profili

- Duljina 2000 mm
- Eloksirano srebro
- Preporučeno ljepilo:
  - Hranipur 05
  - Hranipur SPEED

Materijal od Vrsta vrata	Od Vrsta vodilice	Od profila	Kod
Drvo	Jednostruko	Gornji	F003361
		Donji	F003367
	Dvostruko	Gornji	F003363
		Donji	2× F003367
Staklo	Jednostruko	Gornji	F003361
	Dvostruko	Donji	F003365

**⊕ Riex ES45**  
Gornja vodilica za drvena vrata

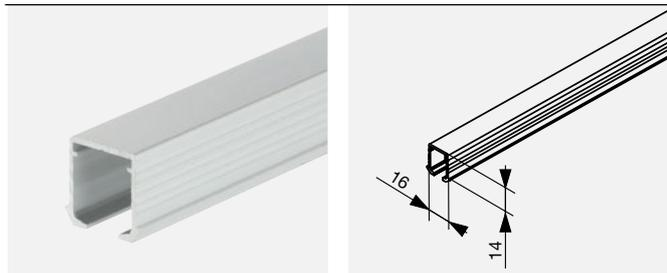

⊕ F003361

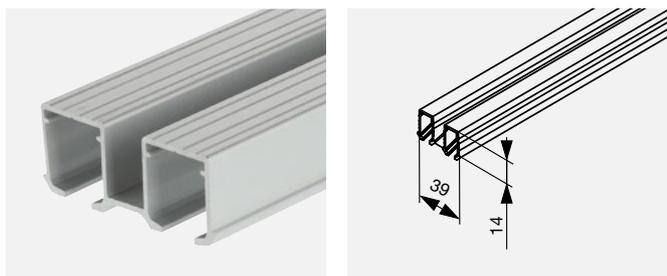

⊕ F003363

**⊕ Riex ES45**  
Gornja vodilica za staklena vrata

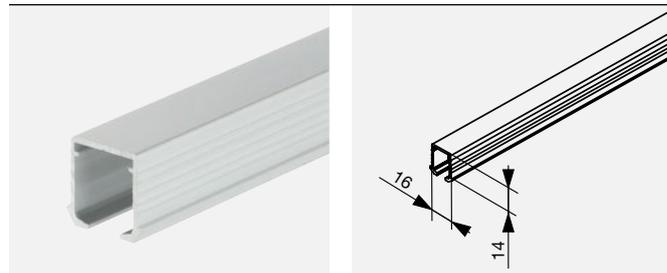

⊕ F003361

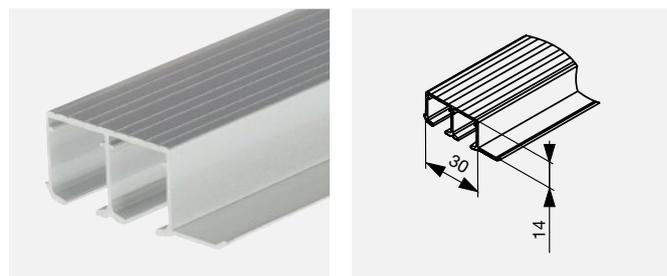

⊕ F003365

**⊕ Riex ES45**  
Donji profil za drvena vrata

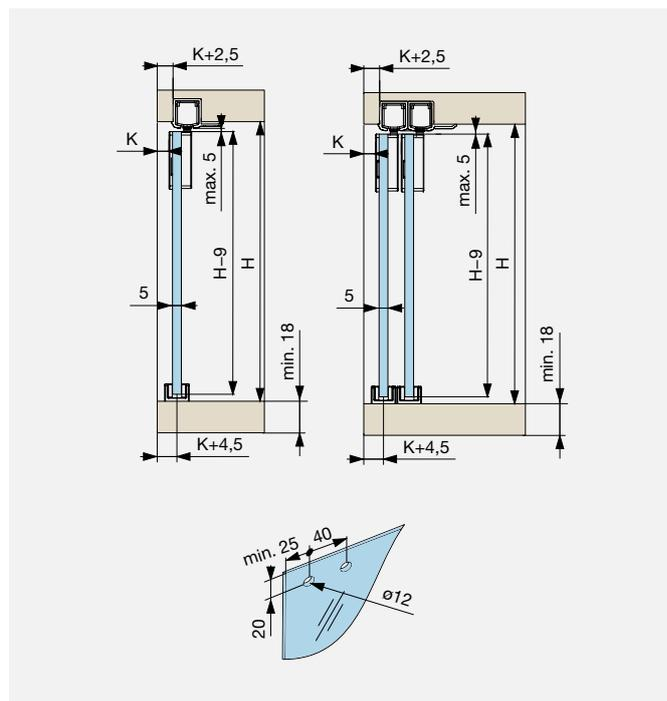
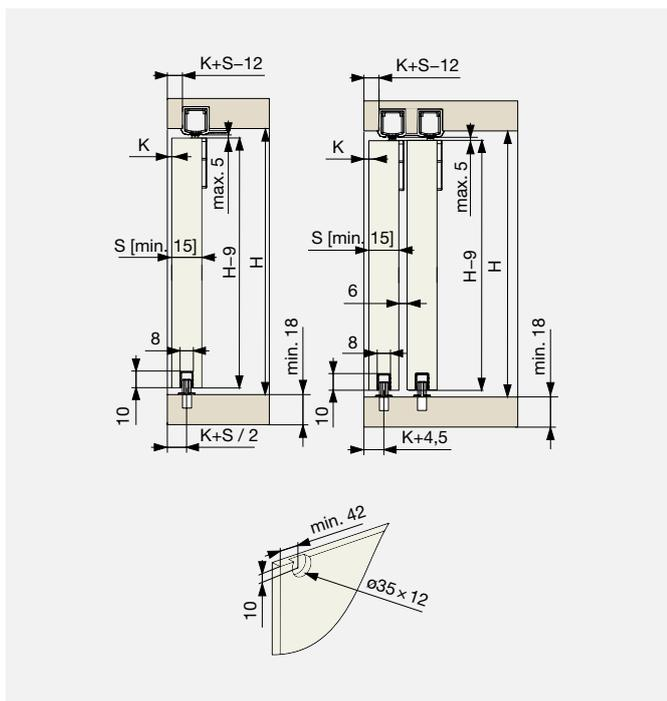
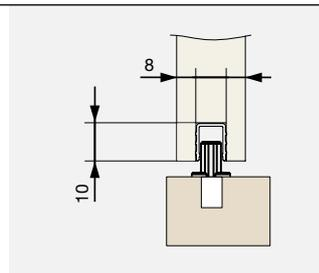
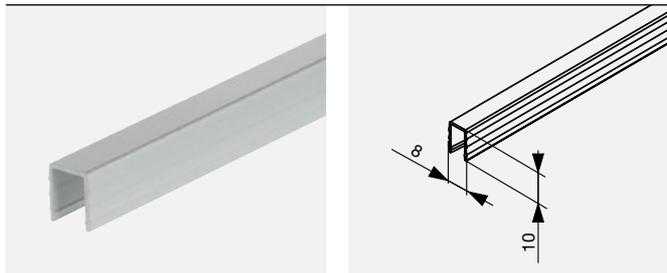

01  
02  
03  
04  
05  
06  
07  
08  
09  
10  
11  
12  
13  
14  
15  
16  
17  
18

# Preklopna vrata za namještaj – Gornja vodilica

- Sklopiva vrata koriste vodilice da izdrže težinu vrata

## Cinetto PS23

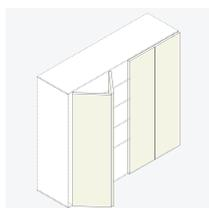

12

- Set za preklopna vrata ne sadrži centralni okov, broj bi trebao biti isti kao i broj bočnog okova
- Donji klizač se preporučuje za visoka vrata
- Nosivost 25 kg po vratima

### ● Cinetto PS23 Set okova za 2 vrata



	Kod
Lijevo strana otvor	F004795
Desni bočni otvor	F004796

### ● Cinetto PS23 profili

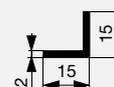
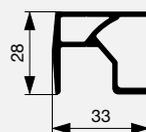

Duljina [mm]	Gornji profil	Donji profil*
2000	F004801	F004803
3000	F004802	F004804

\* Donji profil je preporučen za visoka vrata radi osiguranja stabilnosti.

## ● Pribor



① F004797

① F004798

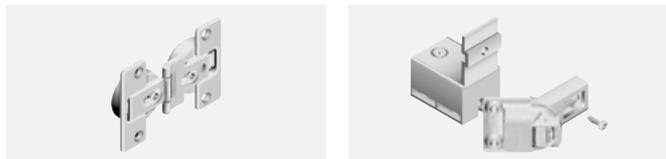

① F004799

① F004800

- Koristite istu količinu središnjih okov kao i bočnog okova

Tip	Kod
Plastični pokriti za kotač	F004797
Središnji okov asimetrična	F004798
Središnji okov podesivi	F004799
Donji klizač*	F004800

\* Donji klizač je preporučuje se za viša vrata [preko oko 2300 mm].

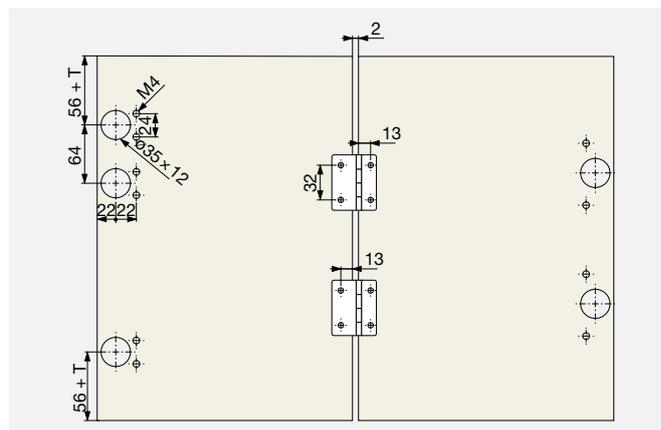
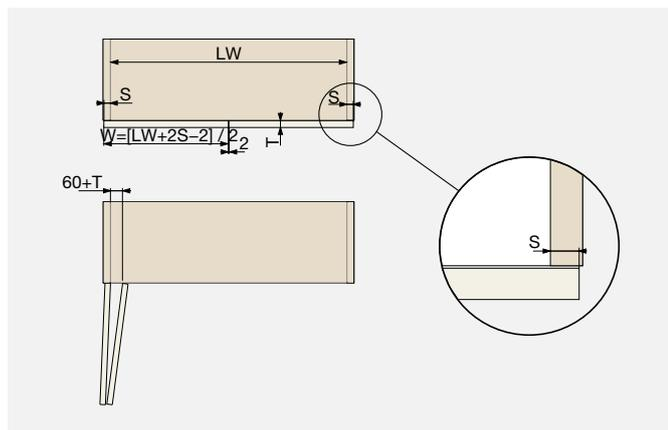
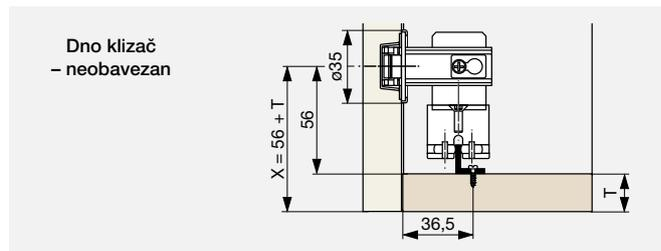
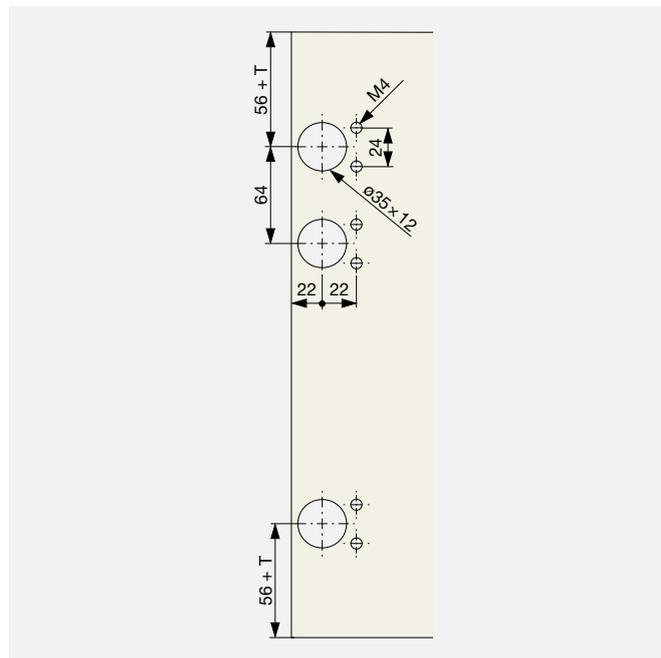
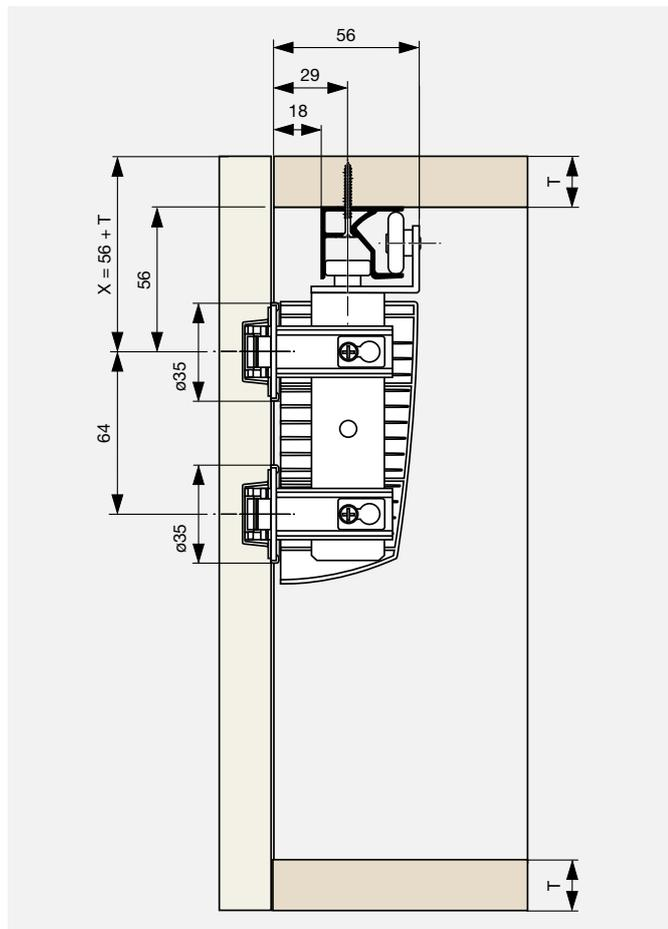

# Okretna i sklopiva džepna vrata

- Hawa – visoka kvaliteta okova za namještaj od švicarskog proizvođača
- Idealan za kućni ured, sobe s kuhinjom, dizajnirana mjesta
- Pokrivanje radnog područja u momentu
- Concepta [rješenje za jedna vrata] može se kombinirati s Concepta Preklopna [dvoja sklopiva vrata]



# Hawa Concepta i Sklopiva Concepta Family

- Alternativna opcija za pokrivanje



## DJELOMIČNO – POKRIVNOST SAMO U GORNJEM DIJELU

- Jedna vrata ili preklopna vrata dostupno
- Lijevo Preklapanje Concepta visina 1250–1850 u kombinaciji s Concepta 25



## POTPUNO POKRIVANJE

- Jedan vrata, preklapanje ili kombinacija
- Lijevo Preklapanje Concepta za visina 1850–2600 u kombinaciji s Concepta 35\*

\* Concepta 35 ima maksimum visine 2300 mm, za višu aplikacija koristi Concepta 50.

# Hawa Concepta

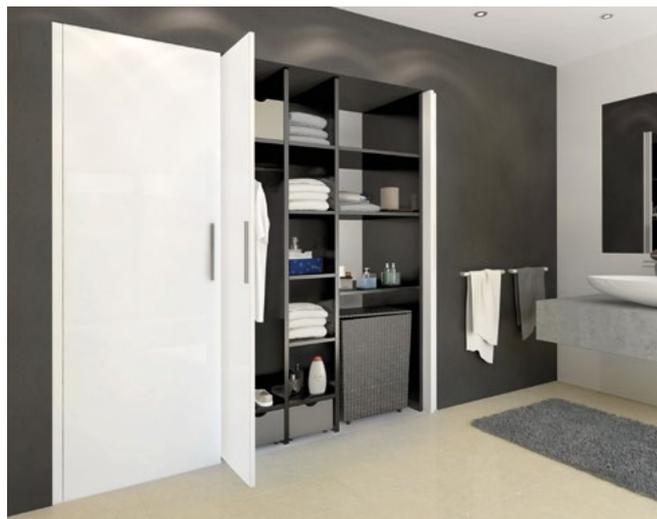
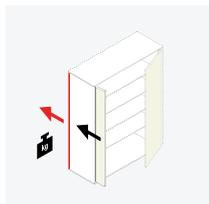

- Sustav skrivenih vrata u džepu
- Soft-close za obje strane
- Novi, Prije montiran Concepta 35 ubrzati instalaciju i pokriva većinu zahtjeva
- Podržava kapacitet 25–50 kg po vratima prema tipu i visini vrata

## ● Hawa Concepta

Video instalacija :



Concepta 25



Concepta 50

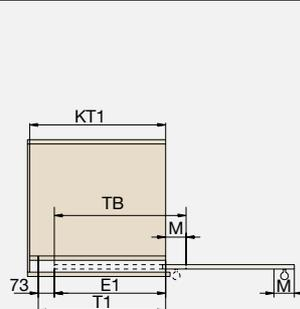
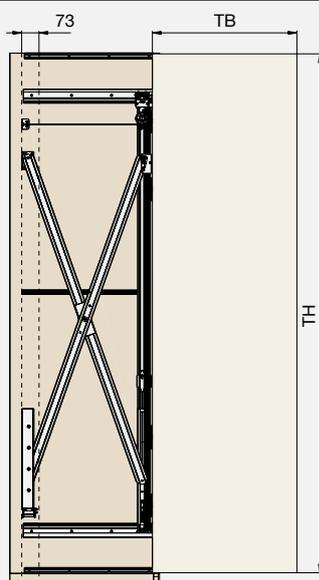

$$T1 = TB - M + 73$$

$$E1 = T - 73$$

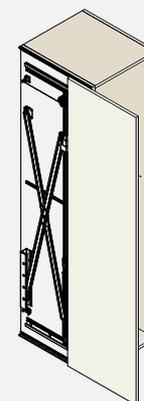

T1  
[mm]

TH  
[mm]

E1  
[mm]

≤ 823

1950–2300

≤ 750

Tip	Visina vrata TH [mm]	Težina vrata [kg]	Opis	Kod
Concepta 25	1250–1850	25	Set za 1 vrata	F004769
Concepta 35	1950–2300	35	Unaprijed montirano – lijeva vrata*	F004770
			Unaprijed montirano – desna vrata*	F004771
Concepta 50	2301–2850	50	Set za 1 vrata	F004772

\* Unaprijed montiran Concepta je sastavljena, postavljeno za 1 vrata lijevo / spremno odmah za brzu montažu.

## ● Hawa Concepta Pribor

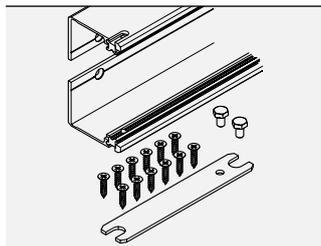

© F005033

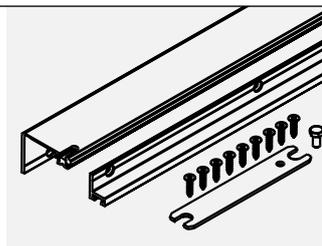

© F005034

- Povezivanje profila na vanjsku stranu ili tijelo ormara

Tip	Kod
Veza profil 55 mm, duljina 650 mm	F005033
Veza profil za Concepta 35 prethodno montiran 55 mm, duljina 650 mm	F005034



## Maks. težina vrata [kg]

- Kraća vrata imaju manji kapacitet
- Tablica maksimalne težine prema visini vrata

### Concepta 25

Visina od vrata TH [mm]	Širina vrata u mm [TB]									
	300	350	400	450	500	550	600	650	700	750
1250	25	25	24	23	21	19	17	15	14	13
1300	25	25	25	24	22	20	18	15	15	14
1350	25	25	25	24	23	21	19	18	16	15
1400	25	25	25	25	24	21	19	17	16	15
1450	25	25	25	25	24	22	20	18	17	16
1500	25	25	25	25	25	23	21	18	18	17
1550	25	25	25	25	25	24	21	19	18	18
1600	25	25	25	25	25	24	22	20	19	18
1650	25	25	25	25	25	25	23	21	20	19
1700	25	25	25	25	25	25	24	21	21	20
1750	25	25	25	25	25	25	24	22	21	21
1800	25	25	25	25	25	25	25	23	22	21
1850	25	25	25	25	25	25	25	24	23	22

kg

### Concepta 35

Visina od vrata TH [mm]	Širina vrata u mm [TB]									
	300	350	400	450	500	550	600	650	700	750
1950	35	35	35	35	35	35	33	31	29	27
2000	35	35	35	35	35	35	33	30	28	26
2050	35	35	35	35	35	35	33	30	28	26
2100	35	35	35	35	35	35	32	30	28	26
2150	35	35	35	35	35	35	32	30	27	26
2200	35	35	35	35	35	35	32	29	27	25
2250	35	35	35	35	35	34	31	29	27	25
2300	35	35	35	35	35	34	31	29	27	25

kg

### Concepta 50

Visina od vrata TH [mm]	Širina vrata u mm [TB]												
	300	350	400	450	500	550	600	650	700	750	800	850	900
2301	50	50	50	50	50	50	50	49	48	47	46	45	43
2350	50	50	50	50	50	50	50	50	49	48	47	45	44
2400	50	50	50	50	50	50	50	50	50	48	48	46	45
2450	50	50	50	50	50	50	50	50	50	49	48	47	45
2500	50	50	50	50	50	50	50	50	50	50	49	48	46
2550	50	50	50	50	50	50	50	50	50	50	50	48	47
2600	50	50	50	50	50	50	50	50	50	50	50	50	48
2650	50	50	50	50	50	50	50	50	50	50	50	50	49
2700–2800	50	50	50	50	50	50	50	50	50	50	50	50	50

kg

 01  
02  
03  
04  
05  
06  
07  
08  
09  
10  
11  
12  
13  
14  
15  
16  
17  
18

# Hawa Folding Concepta

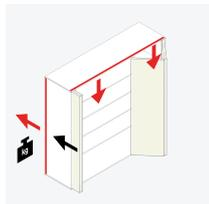

- Sustav za preklapanje vrata postavljenih u džep
- Sklopivi namještaj u ravni pročelja
- Nosivost 25 kg po vratima
- Set za 2 vrata

## ● Hawa Folding Concepta

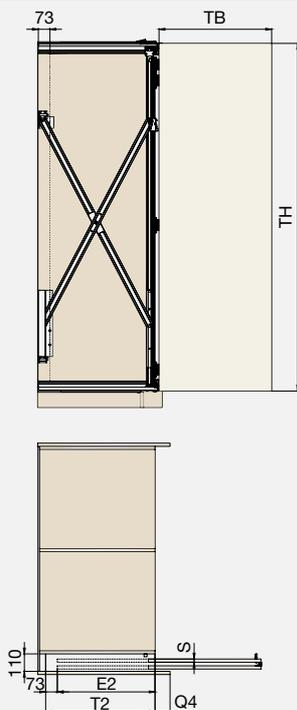

$$T2 = TB - Q4 + 73 \text{ mm}$$

$$E2 = T2 - 73 \text{ mm}$$

$$Q4 = S + 75 \text{ mm}$$

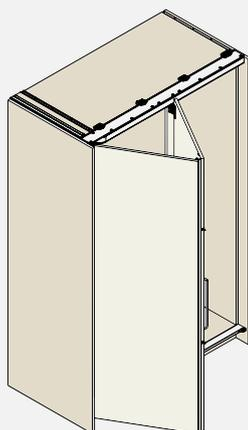

Video instalacija:

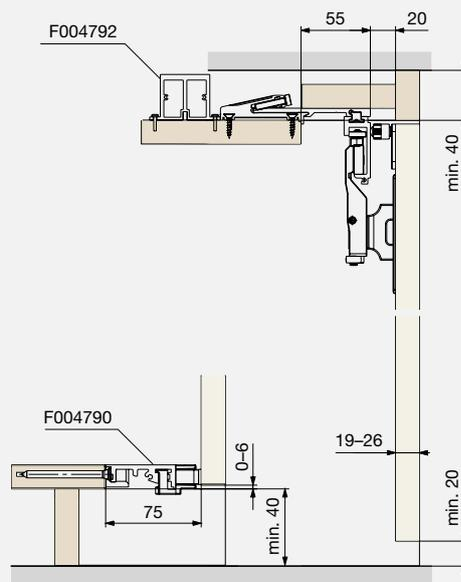

T2 [mm]	TH [mm]	E2 [mm]
≤ 680	1250–1850	≤ 607
≤ 680	1851–2600	≤ 607

Smjer otvaranja	Visina od vrata TH [mm]	Eloksirano srebro	Crno eloksiran
Lijevo	1250–1850	F004773	F004777
	1851–2600	F004775	F004779
Ravno	1250–1850	F004774	F004778
	1851–2600	F004776	F004780

Uvlačenje pročelja u džep omogućeno je skrivenim kotačićima. U slučaju izražene strukture krila vrata, preporučljivo je zalijepiti tanki glatki rub na hodnu točku kolica kako bi se osigurao tiši hod [stražnja strana vrata].

## ● Pribor za Hawa Folding Concepta

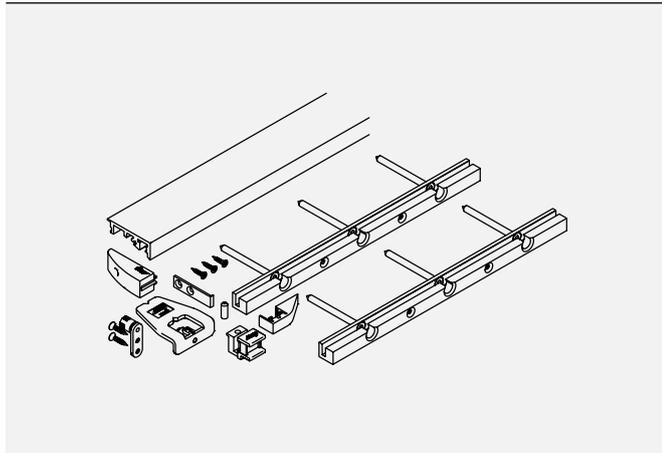

① F004790

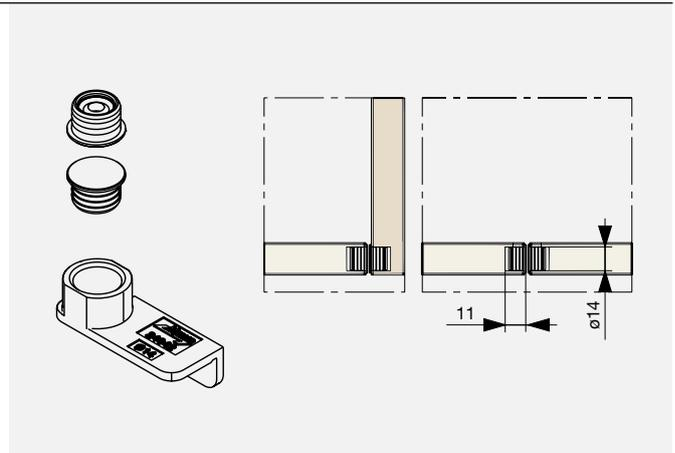

① F004791

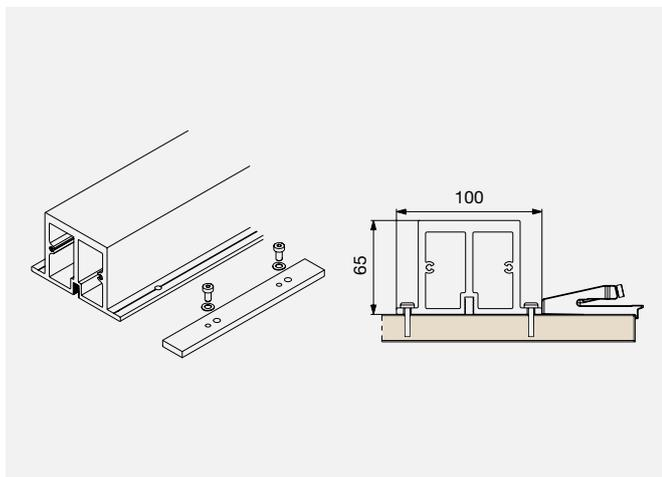

① F004792

Osnovni profil postavlja prednji dio ormara u ravninu s gornjim dijelom. Set s priborom, eloksirano srebro.

Dijelovi za magnetno centriranje središnja su vrata walk-in ormara bez baze ormara ili vrata s udubljenjem. Set uključuje šablonu za bušenje.

Pojačanje profila je preporučeno za širok ormar, u kombinaciji sa više vrata, posebno u slučaju ormara bez pregrada. Set sa priborom, eloksirano srebro.

Korištenje osnovnog profila i profil pojačanja– vidjeti slike na str. 12.23

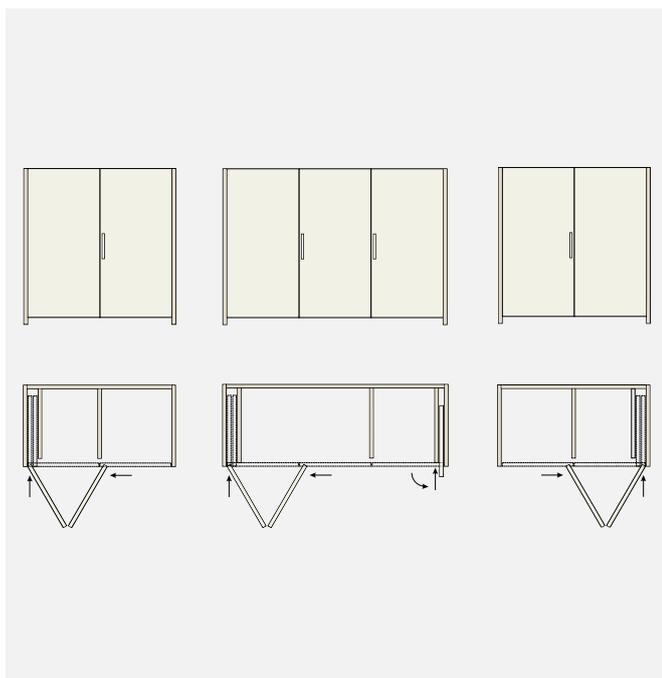

① Kombinacija Preklapanja Concepta i Concepta

Tip	Kod
Baza profil 1300 mm, [set]	F004790
Magnetski centriranje dio, set	F004791
Pojačanje profil 2600 mm, set	F004792

# Klizna vrata za namještaj s donjom vodilicom

- Donja vodilica dozvoljava jednostavniju konstrukciju garderobnog omara
- Težina je na donjoj tračnici, tako Gornji dio ne mora biti ojačan



# Riex ES40

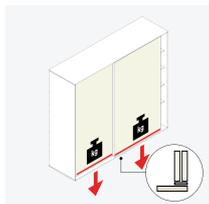

- Plastični sustav za male ormariće s kliznim vratima
- Nosivost 10 kg po vratima

## ⊕ Riex ES40 Plastični klizni sustav – okovi



● Smeđa



○ Bijelo



● Smeđa



○ Bijelo

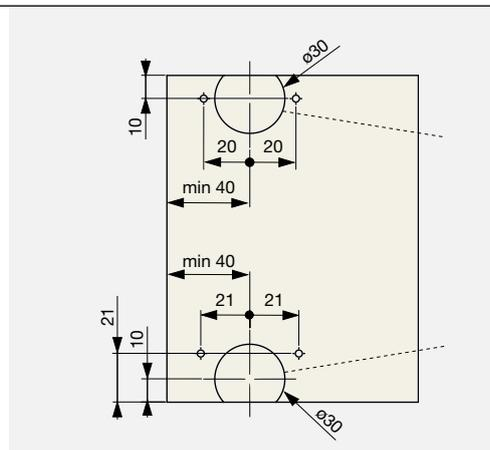

Tip	Bijelo	Smeđa
Gornji kotač	F003385	F003386
Donji kotač	F003388	F003389

## ⊕ Riex ES40 plastične šine



● Smeđa



○ Bijelo

Preporučeno ljepilo:

- Hranipur 05
- Hranipur SPEED

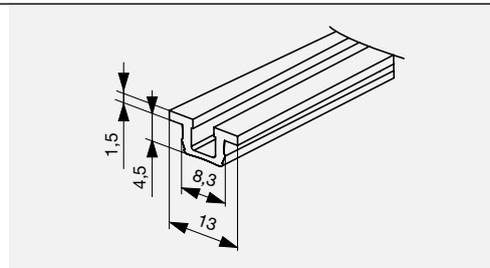

Duljina [mm]	Bijelo	Smeđa
1200	F003391	F003392
2000	F003394	F003395

# Riex ES65

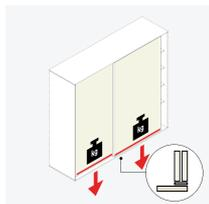

- Sustav za garderobu, veći ormar s kliznim vratima
- Potpuno soft-close zatvaranje [4 kom amortizera]
- Glatka i tiha funkcija
- Montaža moguće bez utora
- Nosivost 50 kg po vratima

## ⊕ Riex ES65 Klizna Sustav – Priključci



- Set uključuje 4 amortizera

© F003368

Set za	Kod
2 vrata	F003368
3 vrata	F003369

12

## ⊕ Riex ES65 Središnja prigušnica



- Za korištenje srednjeg prigušivača, srednja vrata moraju biti postavljena u stražnjem položaju

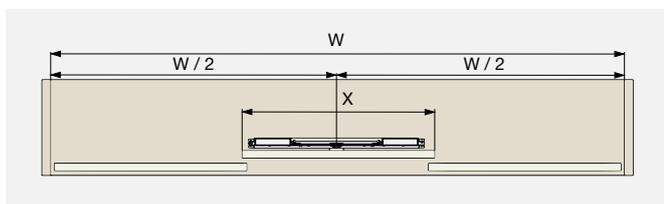

Tip	Kod
Set [prigušivač + prihvatnik]	F003370

## ⊕ Riex ES65 vodilice

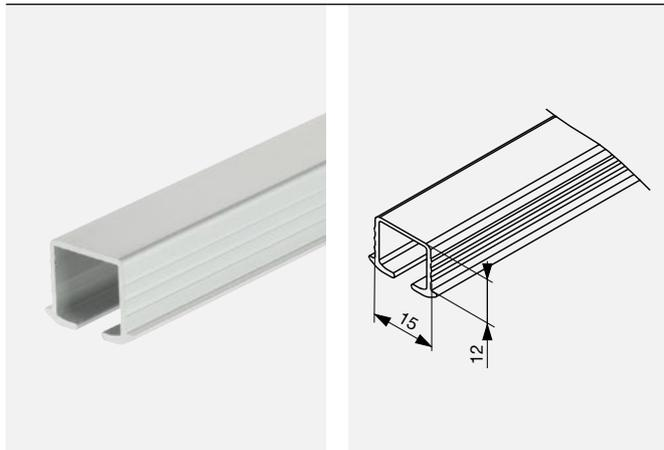

### Jednostruka vodilica

- Može se koristiti u gornjoj i donjoj poziciji
- Jednostavna ugradnja
- Eloksirano srebro
- Prigušivači se nalaze ulutar vodilice

### Preporučeno ljepilo:

- Hranipur 05
- Hranipur SPEED

Duljina [mm]	Kod
2000	F003374
3000	F003375
4000	F003376



### Dvostruke vodilice

- Set gornjih i donjih vodilica
- Površinska instalacija
- Srebrno eloksiran
- Prigušivači se nalaze ulutar vodilice

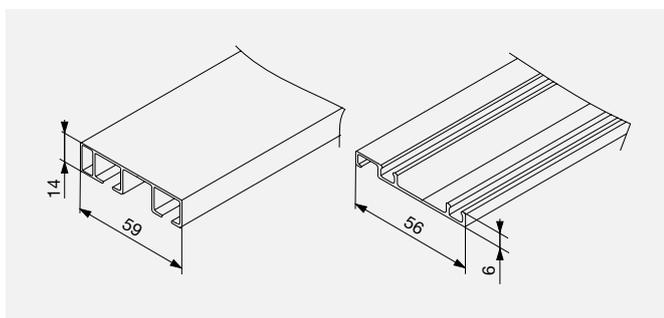

Duljina [mm]	Kod
2000	F003371
3000	F003372
4000	F003373

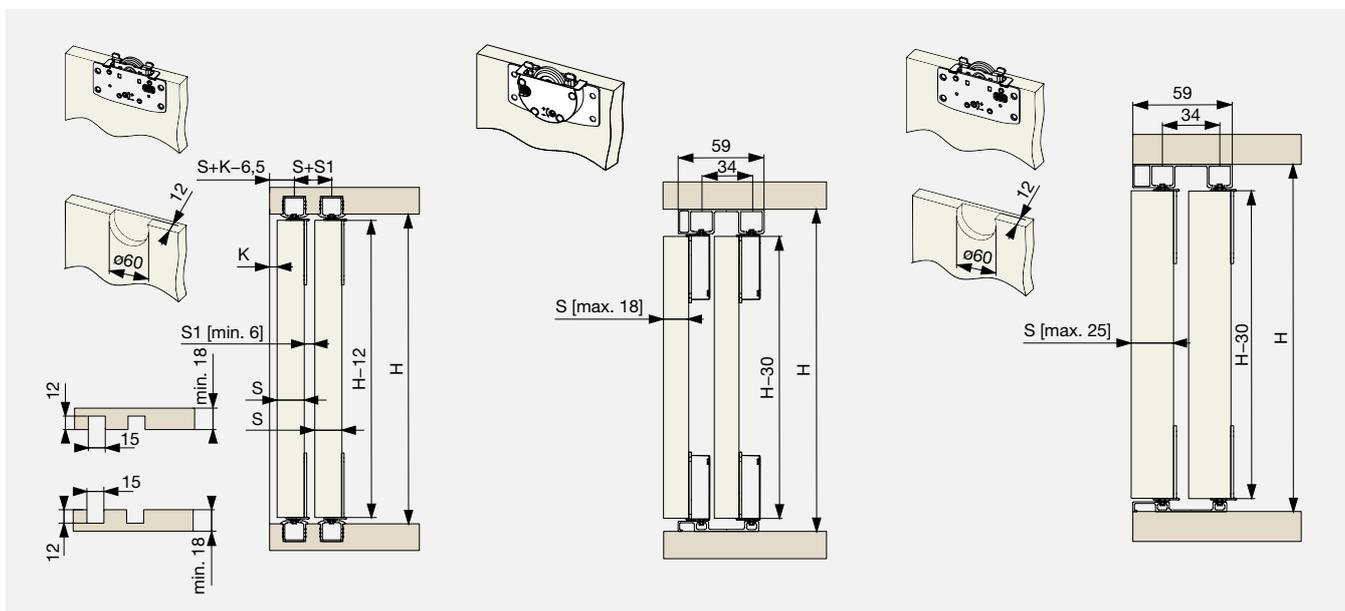

# Hawa Combino

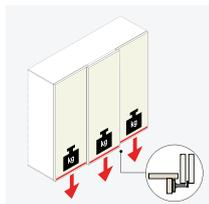

- Sustav pokretanja s donje strane s težinom vrata na bazi
- Nosivost 50 kg po vratima
- Debljina 19 mm

## ● Hawa Combino 50 H FS – Fittings

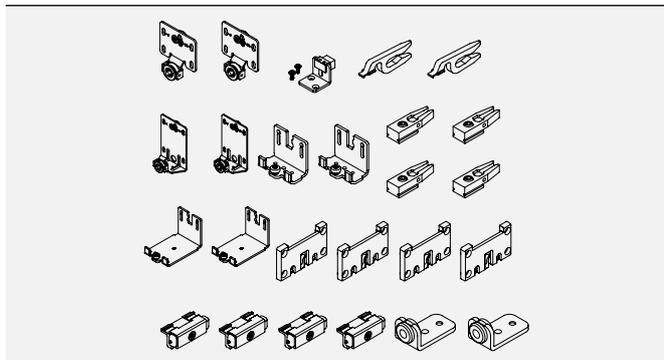

① Okovi [2 vrata verzija]

- Montaža bez soft-close zatvaranja

Video instalacija:

Minimum širina vrata:

- 1 bočno prigušenje 450 mm
- 2 strane prigušenja 600 mm



Set za	Kod
2 vrata	F004745
3 vrata	F004746

## ● Hawa Combino 50 H FS Soft-close

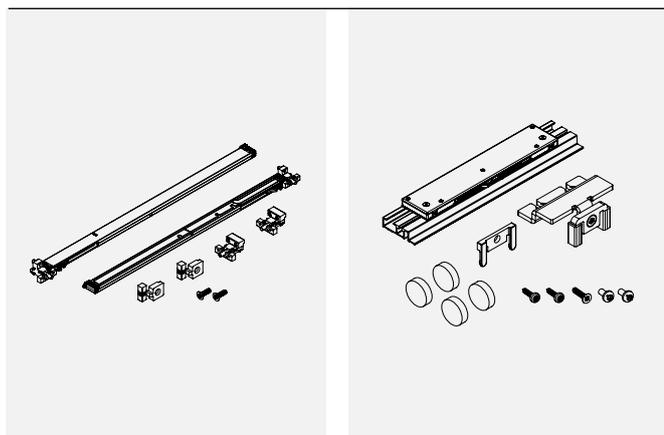

① F004747

① F004748

Tip	Kod
2 vrata s soft-close zatvaranjem [1 strana prigušivanje]*	F004747
Soft-close za srednja vrata	F004748

\* Set uključuje 2 kom od prigušnica, 2 postavljaju su potrebna za prigušivanje oba strane.

## ● Hawa Combino 50 H FS vodilice

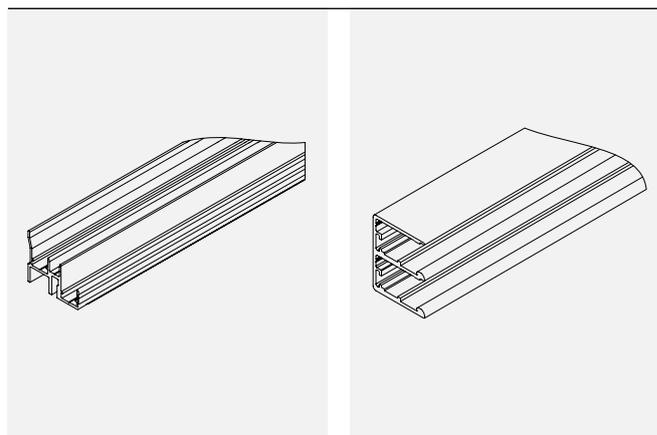

① Gornja vodilica

① Donja vodilica

- Eloksirano srebro, predbušen

Duljina [mm]	Gornja vodilica	Donja vodilica
2500	F004751	F004749
3500	F004752	F004750



- 01
- 02
- 03
- 04
- 05
- 06
- 07
- 08
- 09
- 10
- 11
- 12
- 13
- 14
- 15
- 16
- 17
- 18

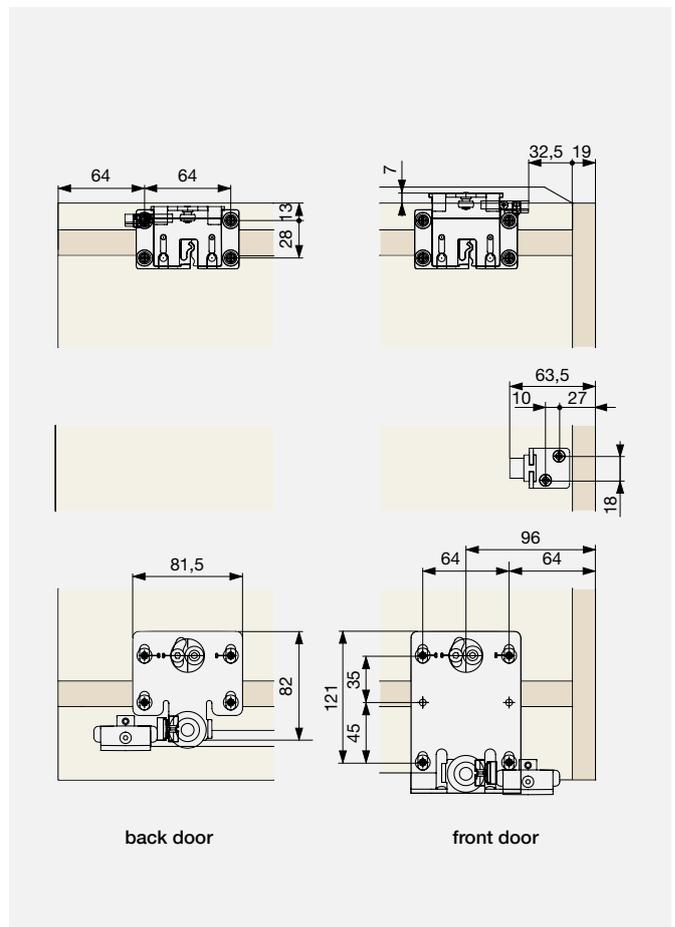
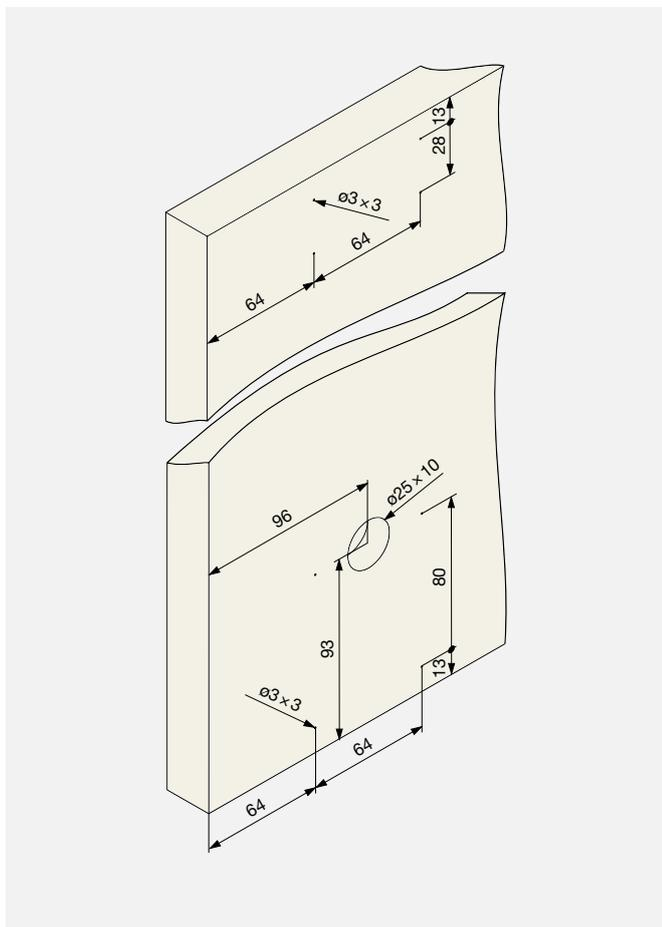
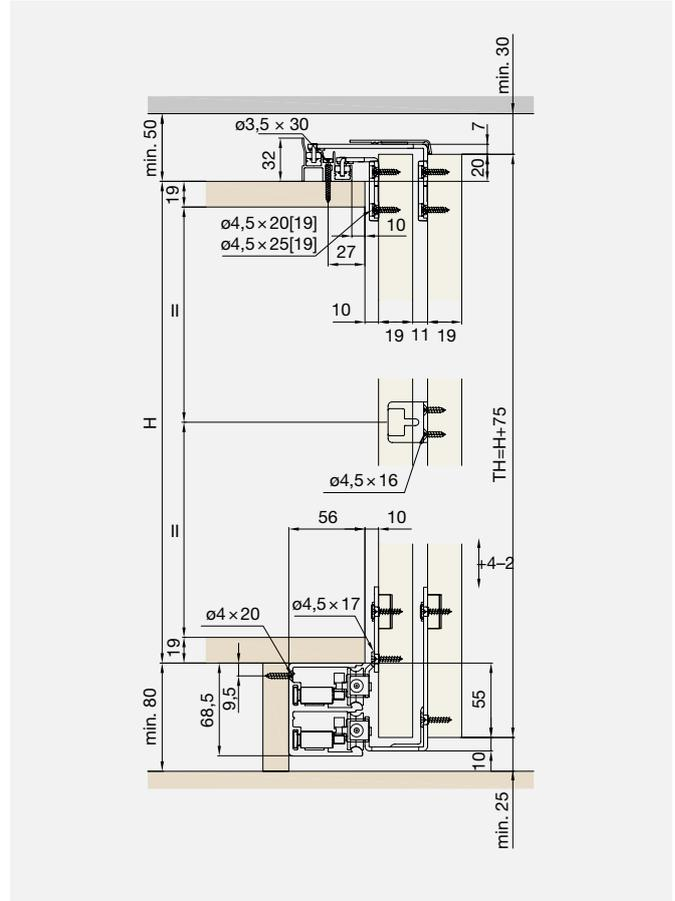
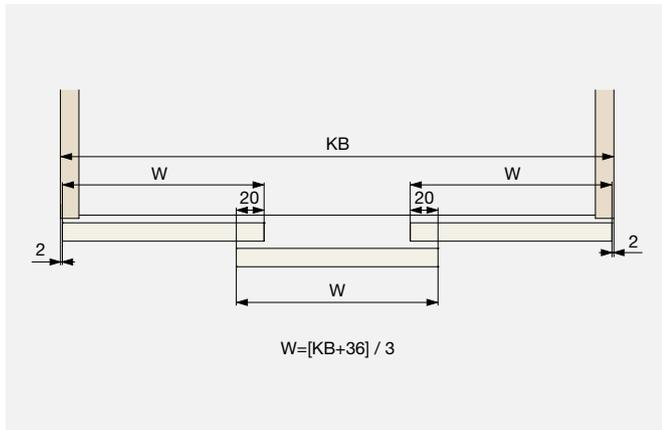
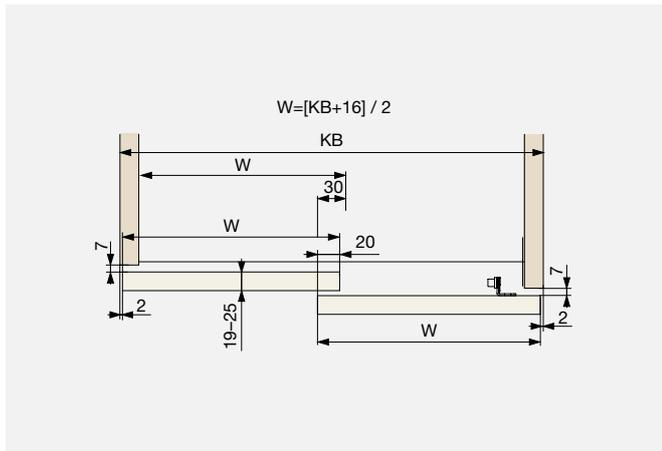

# Riex ES44

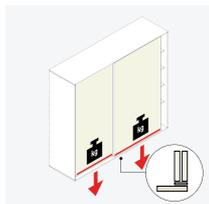

- Sustav za manji ormarić s kliznim vratima
- Nosivost 30 kg po vratima
- Kuglični ležaj

## ⊕ Riex ES44 Klizni sustav – Montaža



- Crna plastika

Tip	Kod
Set za 1 vrata	F003396

## ⊕ Riex ES44 Jednostruka vodilica

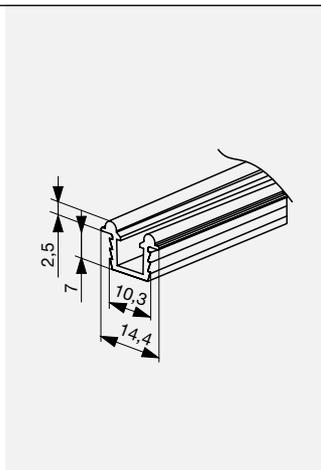

- Srebrno eloksirani
- Preporučeno ljepilo:
- Hranipur 05
  - Hranipur SPEED

Duljina [mm]	Kod
1200	F003397
2000	F003398
3000	F003399

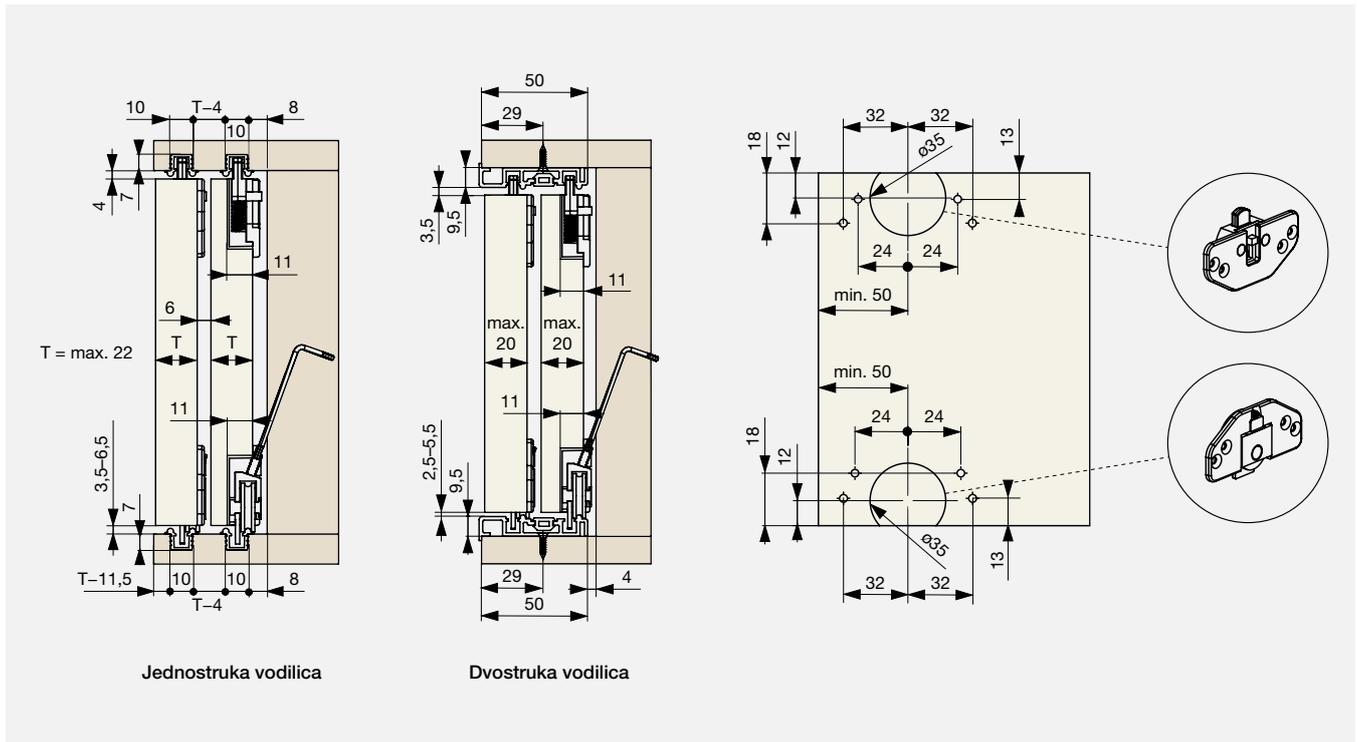

Jednostruka vodilica

Dvostruka vodilica

## ⊕ Riex ES44 dvostruka vodilica

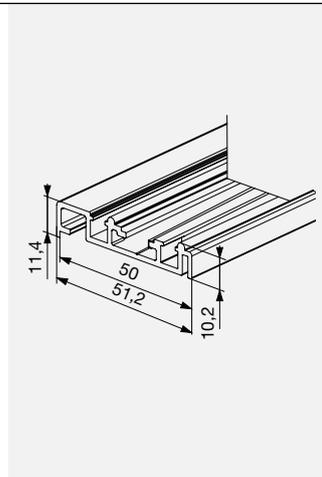

- Srebarno eloksan

Duljina [mm]	Kod
2000	F003401
3000	F003402

## ⊕ Riex ES44 Pokrovni profil za dvostruku šinu

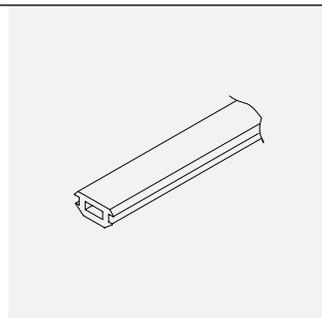

- Poklopac za dvostruku šinu
- Sivo plastični

Duljina [mm]	Kod
3000	F003403

# Okovi za ravnanje



- Veća vrata mogu se izbočiti ili udubiti, posebno korištenjem izvan osi, ili kod donjeg opterećenja
- Može se koristiti i za veće ploče u horizontalnom položaju

## ● Hawa Ugradnja za ravnanje

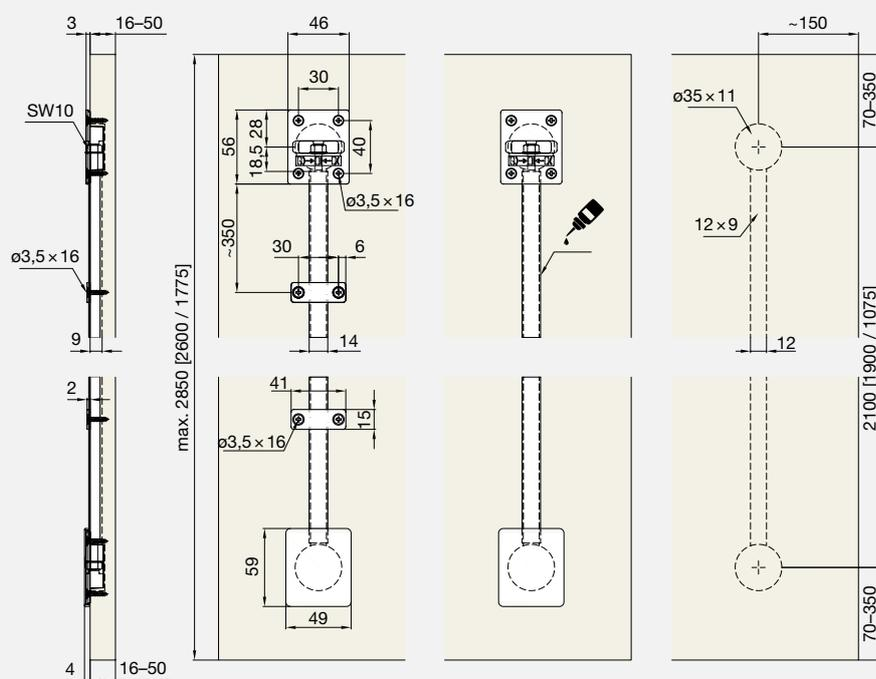

- Set uključuje 2 kom
- Set za jedna vrata do 2600 mm
- Može se skratiti kod vrata 1775–2040 mm

- Preporučeno ljepilo:**
- Hranipur 05
  - Hranipur SPEED

Boja

Kod

Eloksirano srebro

F004793

Crna

F004794

## ⊕ Riex ES02

### Ravnanje vanjskih vrata

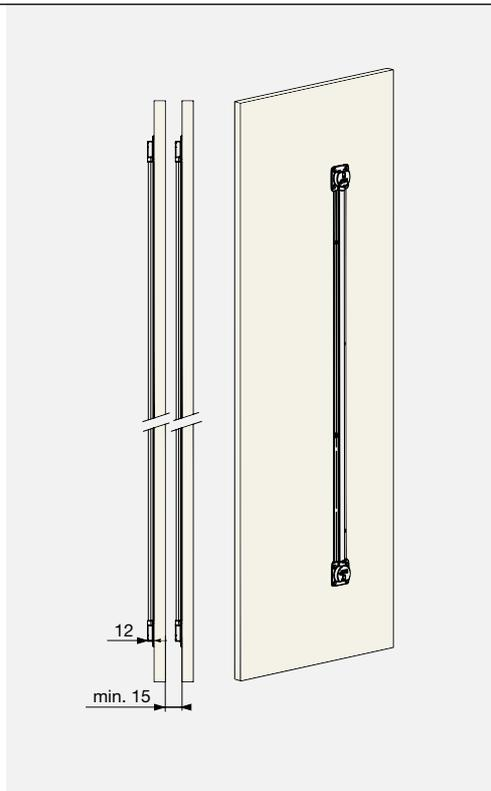

- Vanjski vrata Ravnanje
- Nije potreban utor
- Metalna konstrukcija
- Minimum udaljenost između dvoje vrata za ugradnju 15 mm
- Duljina 2030 mm, može se skratiti

Boja	Kod
Eloksirano srebro	F003377

- Za šira vrata [iznad 600 mm] preporuča se korištenje 2 kom i u horizontalnom položaju
- Za visinu vrata ispod 2200 mm potrebno ih je rezati

## ⊕ Riex ES03

### Ravnanje

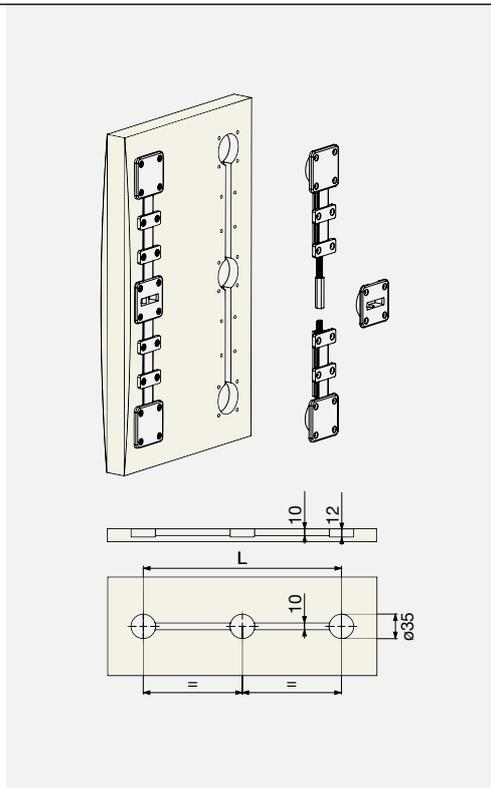

- Ravnanje vrata
- Za odbor min. debljina 18 mm
- Maks. razmak 2250 mm
- Može se skratiti na bilo koju duljinu

- Za šira vrata [iznad 600 mm] preporuča se korištenje 2 kom i u horizontalnom položaju

Boja	Kod
Crna	F003404
Bijela	F003405

# Unutarnja vrata

Klizna interijer vrata su rješenje  
za uštedu prostora. Širok raspon

rješenja pokriva drugačije  
zahtjeve i metode montaže.



12

# Savjeti i preporuke za klizne sustave

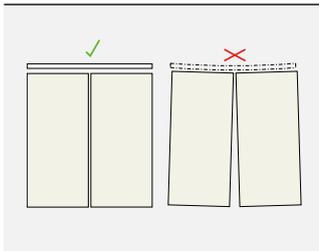

## Vodilice

Ravno i vodoravno pozicionirane vodilice jamče pouzadu funkciju.

Vodilice moraju biti čiste i bez ogrebotina kako bi se osigurao tihi rad.

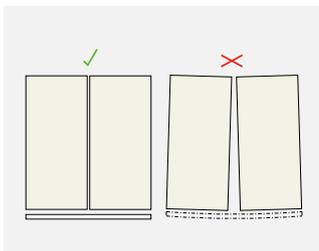

## Kotači

Budite oprezni kada postavljate vrata na ormarić. Očistite i provjerite vodilice prije postavljanja. Kotači se mogu oštetiti čvrstom prljavštinom poput pijeska, metalnih strugotina itd., kao što su oštećene vodilice [udubljenja, ispupčenja itd.]. Nikada ne postavljajte kotač na vodilice.

Pažljivo postavite vrata na vodilicu, udar može stvoriti ravnu površinu na kotaču i tada kotači nikad ne rade tiho. Pravit će redovitu buku prilikom pomicanja vrata.

Ⓢ Točno montaža od vodilice

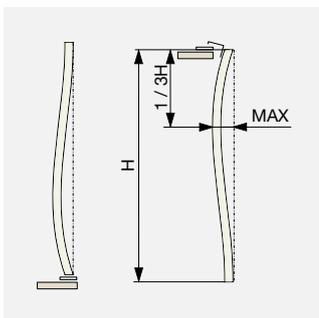

## Zakrivljenje vrata

Posebno se mogu iskriviti vrata koja se preklapaju i visoka vrata. Vrata s preklapanjem vješaju se izvan težišta, tako da uvijek postoji bočna sila koja uzrokuje naginjanje vrata. Visoka vrata mogu se saviti zbog vlastite težine, posebno u rješenjima s donjim utorom.

Za ovaj slučaj preporučamo korištenje okova za ravnjanje, vidi str. 12.33–12.34.

Drugi razlog zakrivljenosti mogu biti dvostruki materijali. Također bojanje, postavljanje folija i sl. samo s jedne strane može biti razlog naginjanja. Ista površina s obje strane može spriječiti ovaj problem.

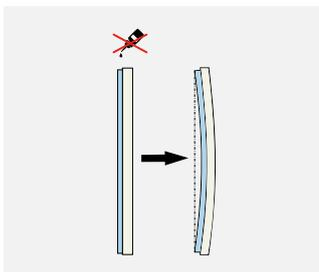

## Nikada ne mažite

### ljepilom za staklo / ogledalo po cijeloj ploči!

Svaki materijal imaju različitu ekspanziju i stoga postoji velika vjerojatnost ulegnuća bez mogućnosti ravnjanja.

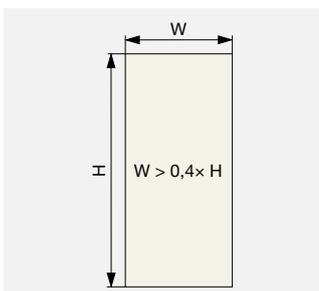

## Ljuljanje [skakanje] vrata

Uska visoka vrata su nestabilna. Posebno u kombinaciji s mekim zatvaranjem i brzo pokretanje će učiniti da vrata skoče. Inercija krila je u središtu, ali su amortizeri obično smješteni na rubu ili izvan krila, dakle postoji poluga koji može podići krilo.

Mi preporučujemo izradu širina vrata više od 40% od visina vrata.

# Sisco Skriven

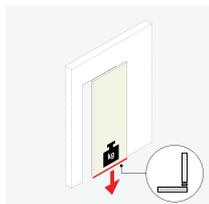

- Sustav sa skrivenom tračnicom
- Težina vrata je opterećena na pod
- Širina vrata maks. 1150 mm
- Zahtijeva tvrdi pod, za tepihe nije prikladan
- Nosivost 80 kg po vratima

## ● Sisco Skriven



- Set za 1 vrata sa šinom
- Potpuno soft-close zatvaranje
- Minimalna širina vrata 650 mm
- Optimalno za širinu konstrukcije 700–900 mm
- Preporučena širina 43% visine vrata
- Amortizeri se moraju aktivirati, prvi put polako otvarati i zatvarati vrata

Vrata težina zaklopka

Kod

40 kg

F004863

80 kg

F004864

© Duljina od vodilice na slici je skraćena

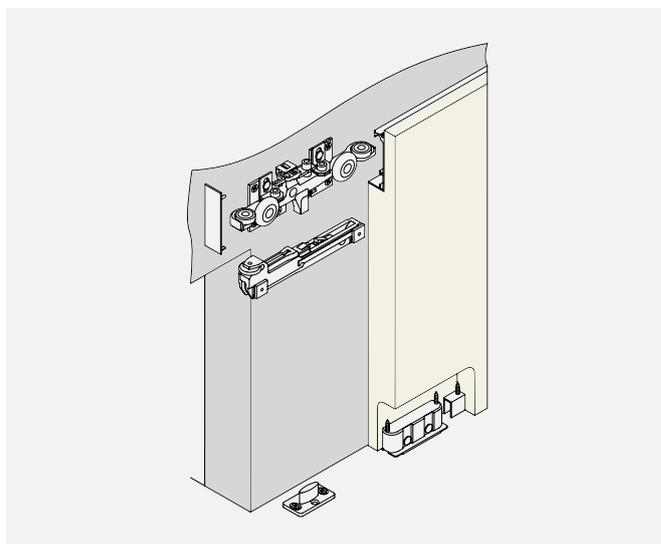
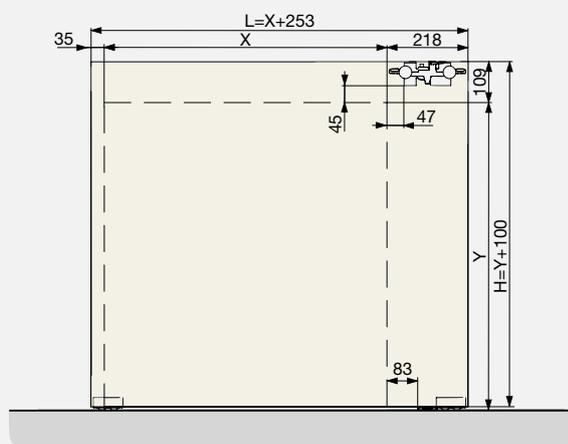



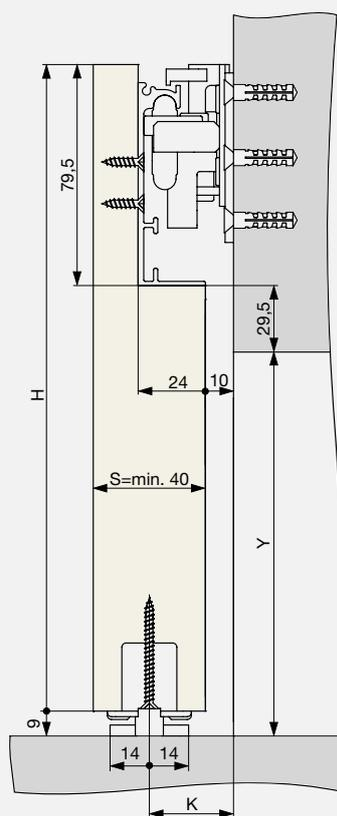

$$H = Y + 100$$

$$K = 10 + S / 2$$

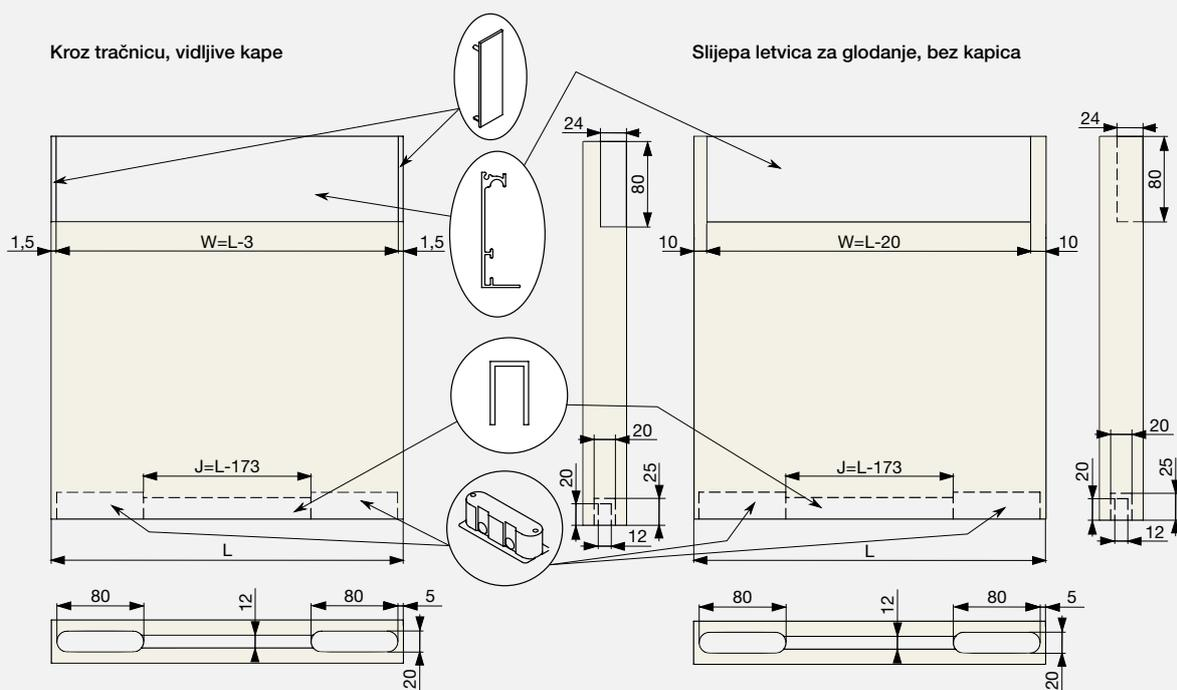

01  
02  
03  
04  
05  
06  
07  
08  
09  
10  
11  
12  
13  
14  
15  
16  
17  
18

# Cinetto PS66

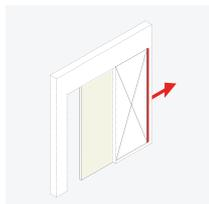

- Sustav bez gornje i donje šine
- Nosivost 50 kg po vratima
- Minimalna visina vrata 2100 mm
- Minimalna širina vrata 1080 mm
- Težina od vrata je opterećena sa strane



## ● Cinetto PS66 Retractable Sliding Door

Smjer otvaranja	Visina vrata [mm]	Mehanizam za uvlačenje		Montažni set za drvena vrata		Montažni set za staklena vrata
Desno	2100–2400	F004826	+	F004830	iii	F004834
	2400–2700	F004827	+	F004831	iii	F004835
Lijevo	2100–2400	F004828	+	F004832	iii	F004836
	2400–2700	F004829	+	F004833	iii	F004837

Da biste dobili funkcionalan sustav potrebno je naručiti: Mehanizam za uvlačenje + komplet za montažu [drvena ili staklena vrata].

12



① F004826

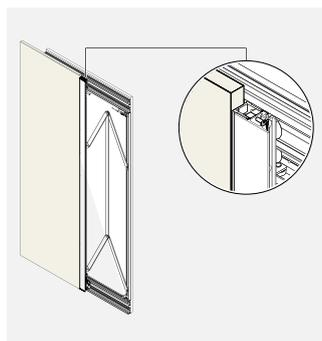

① Mehanizam na pomicanje s drvenim vratima

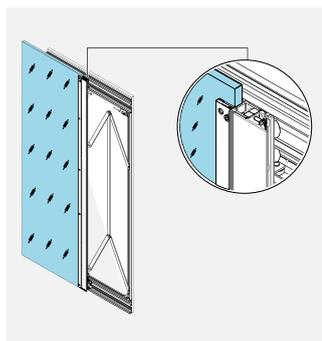

① Mehanizam na pomicanje s drvenim vratima

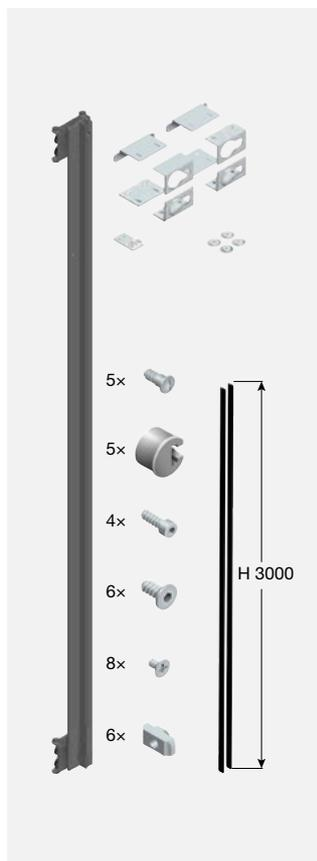

① F004830

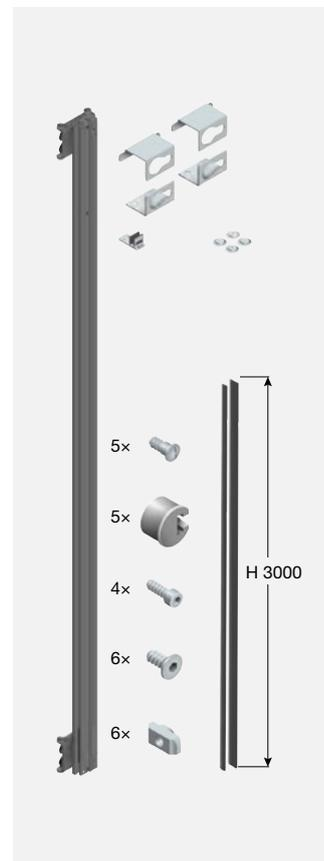

① F004834

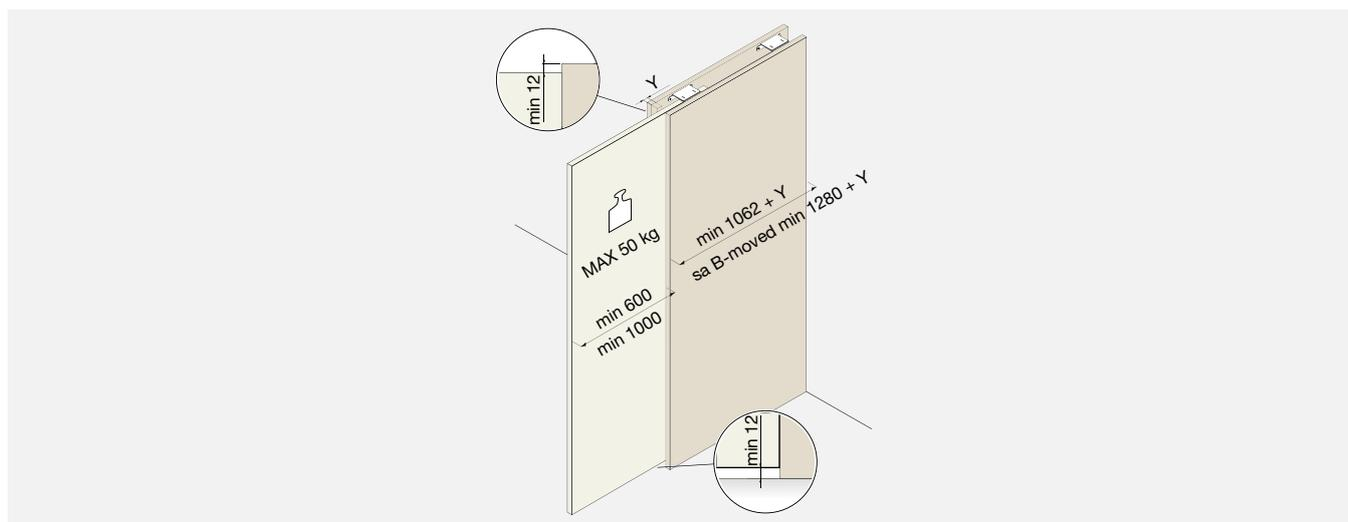

## ● Cinetto PS66 Električno upravljani sustav B-moved

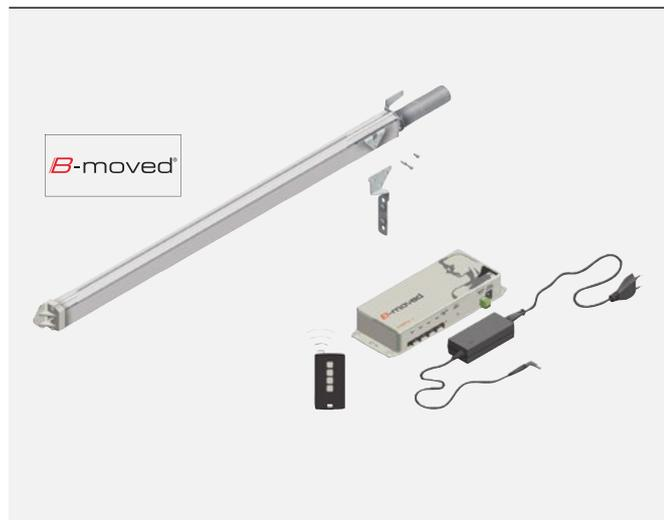

- Električni sustav za otvaranje i zatvaranje vrata
- Standardna verzija treba plus dodirnom za otvaranje / zatvaranje vrata ili koristiti priloženi daljinski upravljač
- Minimalna visina vrata 2200 mm
- Minimalna širina vrata 1280 mm

### Za funkcionalni set morat ćete naručiti:

- B-moved komplet sustava [lijevo ili desno] + kontrola jedinice
- Za rješenje bez dodira dodajte senzor zamaha s kabelom i priborom

Tip	Kod
Kit za desna vrata	F004838
Kit za lijeva vrata	F004839
Elektronička jedinica kontroliranja s daljinskim upravljačem	F004840

## ● Cinetto PS66 senzor zamaha

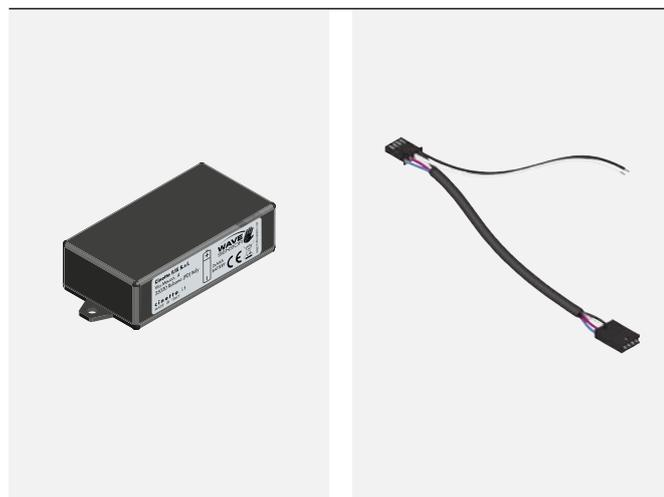

- Poboljšanje s funkcijom bez dodira
- Otvaranje mahanjem ispred senzora
- Senzor zamaha može se postaviti do 10 m od prijemnika
- Bežična veza omogućuje instalaciju izvan ormara
- Senzor zamaha radi kroz materijal debljine najviše 10 mm, osim metalnog ili vodljivog materijala kao što je ogledalo
- Kabel s konektorom namijenjen je za spajanje kontrolera B-mobile jedinice [F004824] na vanjski prekidač [smart home switch uređaj]. Za otvaranje / zatvaranje vrata potreban je puls od oko 0,5 sekundi

Tip	Kod
B-moved Val Senzor	F004825
Kabel za pomoćni kontrolirati ulaz	F004824

# Hawa Junior

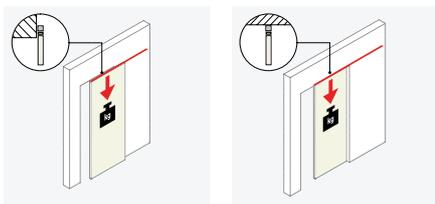

- Hawa – visokokvalitetni okovi za klizna vrata švicarske proizvodnje
- Uklapanje za interijer drvenih vrata
- Neusporedivo nizak otvor sile od maks. 22 N
- Ispoštovani zahtjevi EN 1527:2019
- Nosivost 100 kg po vratima dugotrajno rješenje, jamstvo: 15 godina za privatnu upotrebu 7 godina za komercijalnu upotrebu Provjereno za 100 000 ciklusa, obično preko 25 godina pouzdanog rada



## ● Hawa Junior 100 Z Klizni sustav – Set Okova

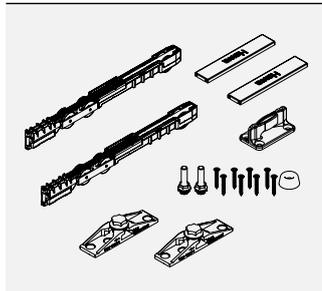

Ⓢ F004719

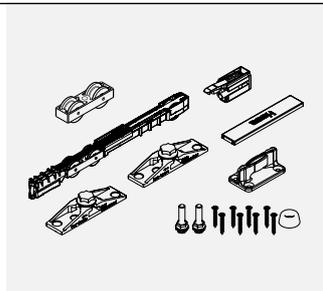

Ⓢ F004720

- Pričvršćivanje stezaljkama, razmak 29 mm ± 4 mm
- Širina vrata bi trebala biti najmanje 40% visine za stabilan rad

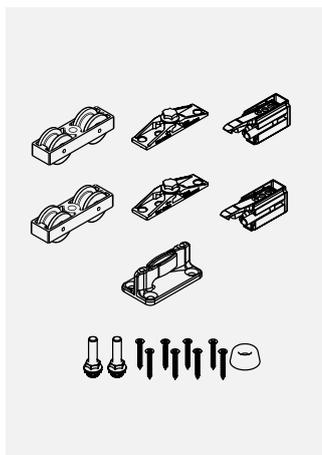

Ⓢ F004721

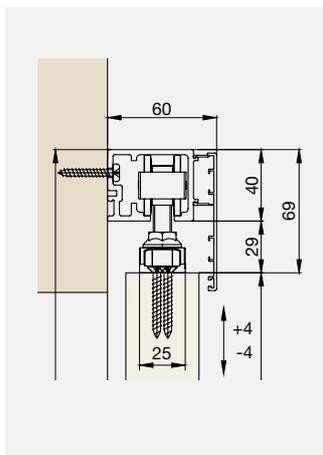

Ⓢ Instalacija sa zidnom tračnicom

Vrsta prigušenija	Min. vrata širina [mm]	Kod
2× magnetski SoftMove	800	F004719
1× magnetski SoftMove, 1× opružni graničnik	650	F004720
2× opružni graničnik	*	F004721

## ● Hawa Junior 100 B Klizni sustav s malim zazorom – Set Okova

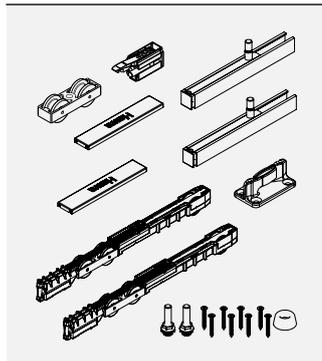

Ⓢ F004722

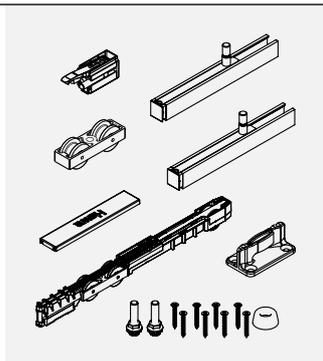

Ⓢ F004723

- Rješenje s malim razmakom, samo 5 mm između vrata i šine
- Skriveno stezaljke, trebaju žljebovi
- Širina vrata bi trebala biti najmanje 40% visine za stabilan rad

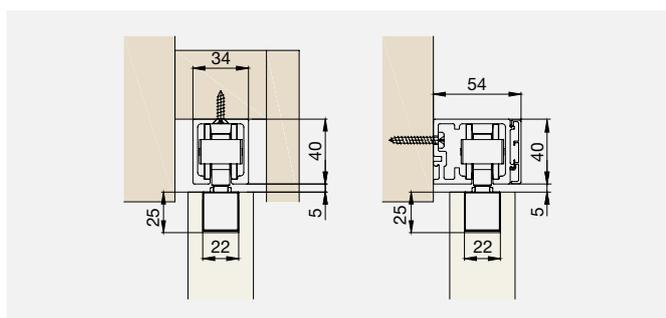

Vrsta prigušenija	Min. vrata širina [mm]	Kod
2× magnetski SoftMove	800	F004722
1× magnetski SoftMove, 1× opružni graničnik	650	F004723

## ● Hawa Junior 100 vodilica

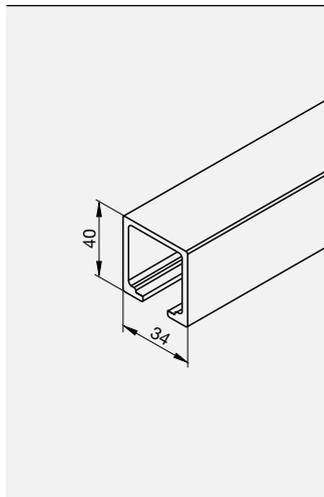

① Strop montaža

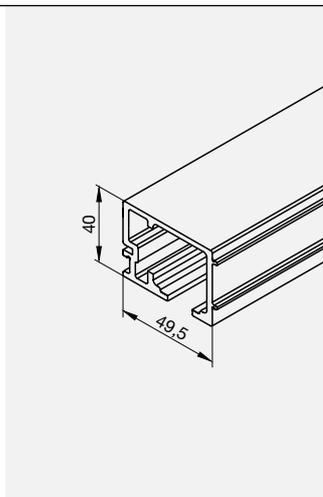

① Zid montaža

Montaža	Duljina [mm]	Kod
Strop	1800	F004724
	2500	F004725
	3000	F004726
	4000	F004727
	6000*	F004728
zid	2000	F004729
	3000	F004730
	6000*	F004731

\* Prije naručivanja profila u dužini 6000 mm molimo provjerite rok isporuke i stanje.

## ● Hawa Junior 100 Pokrivni profili

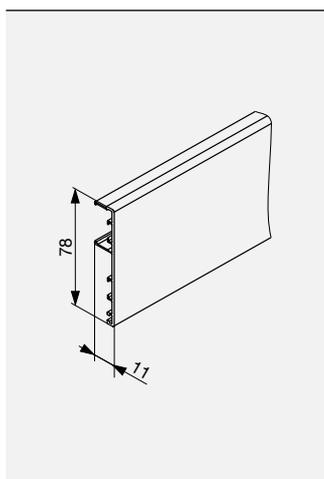

- Poklopac za klasično rješenje
- Srebrno eloksiran

Duljina [mm]	Kod
2000	F004733
3000	F004734
6000*	F004735

\* Provjerite vrijeme isporuke i stanje prije naručivanja profila u dužini 6000 mm.

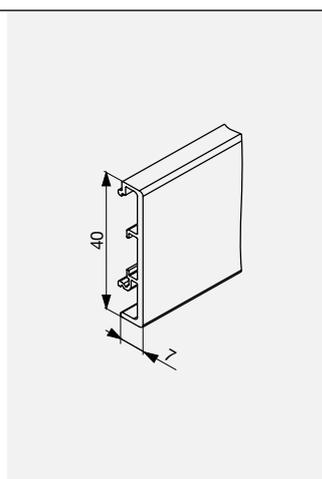

- Rješenje s malim razmakom
- Srebrno eloksiran

Duljina [mm]	Kod
2000	F004736
3000	F004737
6000*	F004738

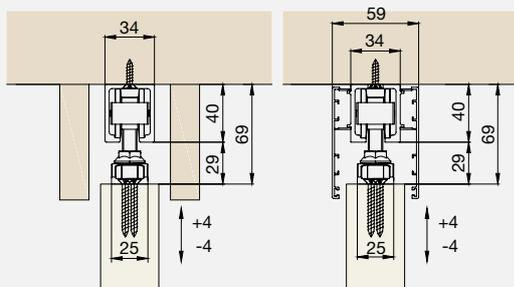

① Strop montaža

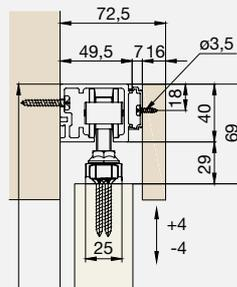

① Montaža na zid

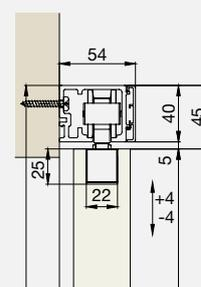

① Zidna montaža s pokrovnim profilom sa malim razmakom

## ● Hawa Junior 100 Spacer za Deblja Vrata

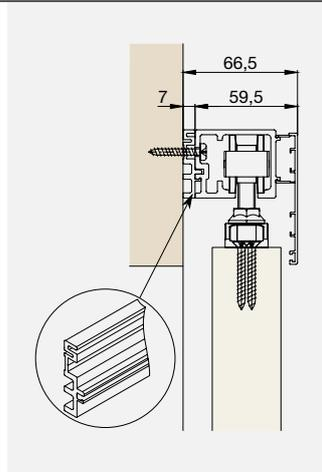
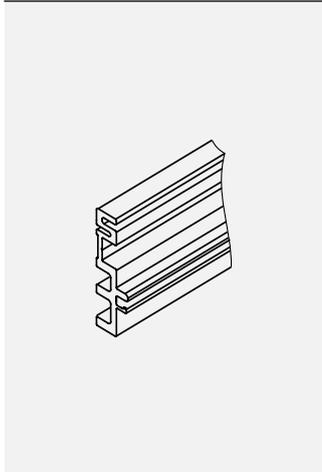

© Zidna montaža s razmacima

- Rješenje za deblja vrata i zidne šine
- Proširi udaljenost od zid + 7 mm
- Sivo plastični

Duljina [mm]	Kod
2000	F004732

## ● Hawa Junior 100 Vodilica Profil

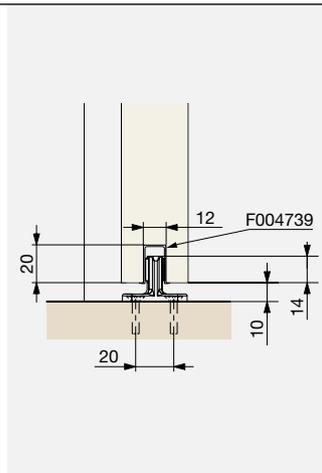
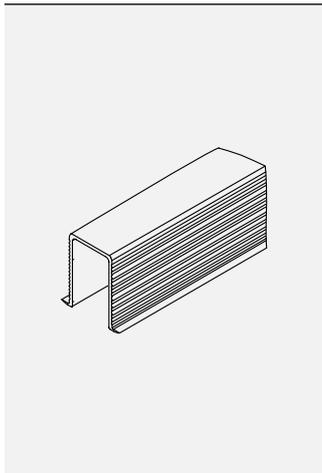

- Donji profil za glatko i tiho kretanje
- Plastični

Duljina [mm]	Kod
1300	F004739

## ● Hawa Junior 100 Donja vodilica

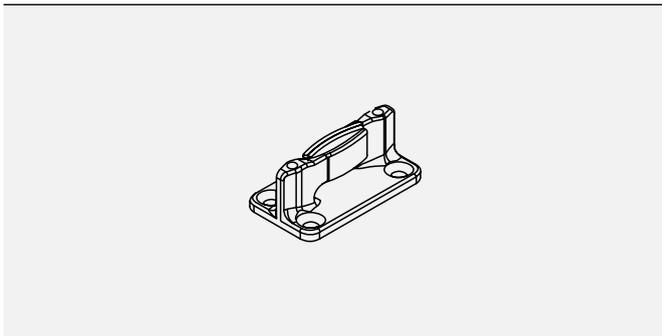

- Dizajnirano za vrata protiv potresanja u kombinacija s vodicom profila
- Crna plastika

Tip	Kod
Donja vodilica	F004740

● **Hawa Junior 100**  
**SoundEx**

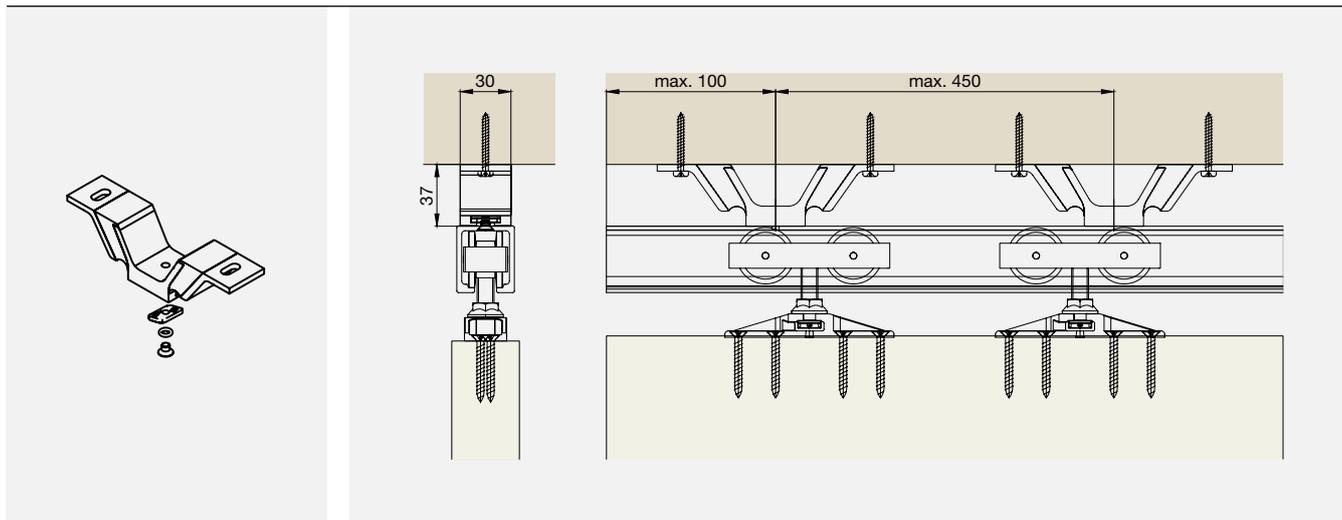

- Smanjivanje buke elemenata korištenjem između stropa i vodilice smanjuje prijenos buke i vibracija

Tip	Kod
SoundEx element	F00471

● **Hawa Junior 100**  
**Isječak za drvenu ploču**

12

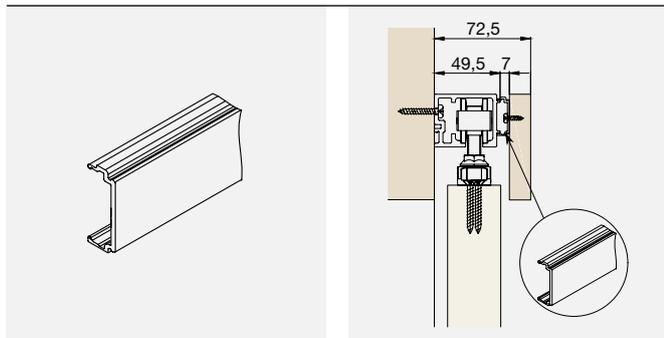

- Za pričvršćivanje ploče na šinu.

Ⓢ Zidna montaža drveni ploča

Tip	Kod
Spojnica	F00472



## ● Hawa Junior džepni profil

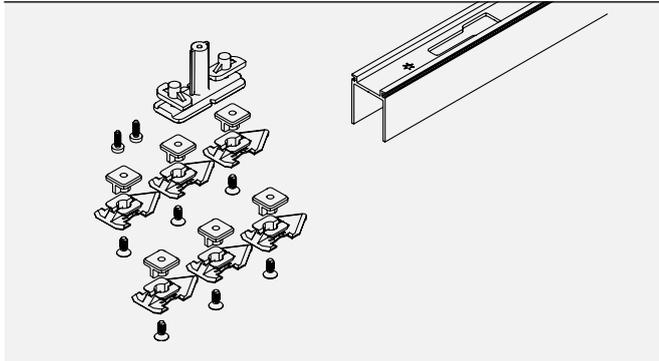

- Dodatni profil za džepna vrata, za montažu na strop
- Standardna vodilica je ugrađena unutar ovog profila
- Bajonet brava omogućuje naknadnu ugradnju ili uklanjanje vodilice u slučaju popravka
- Pripremljeno za Hawa Junior 100 stropni profil
- Set profila sa priborom

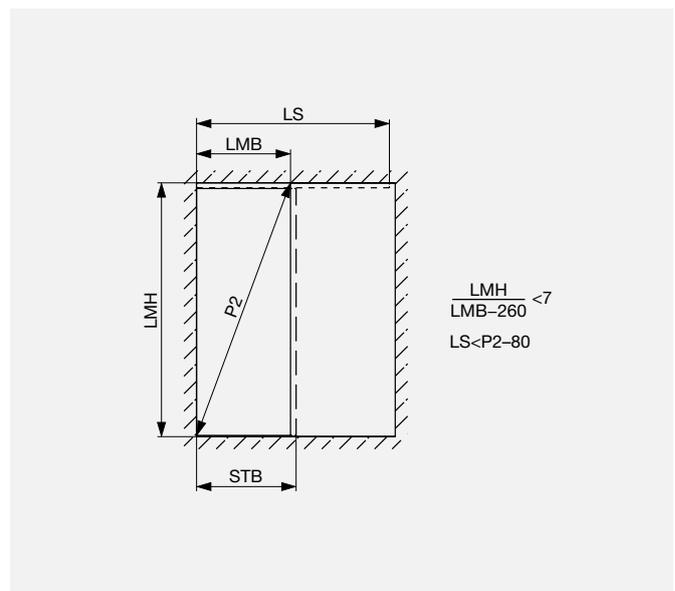
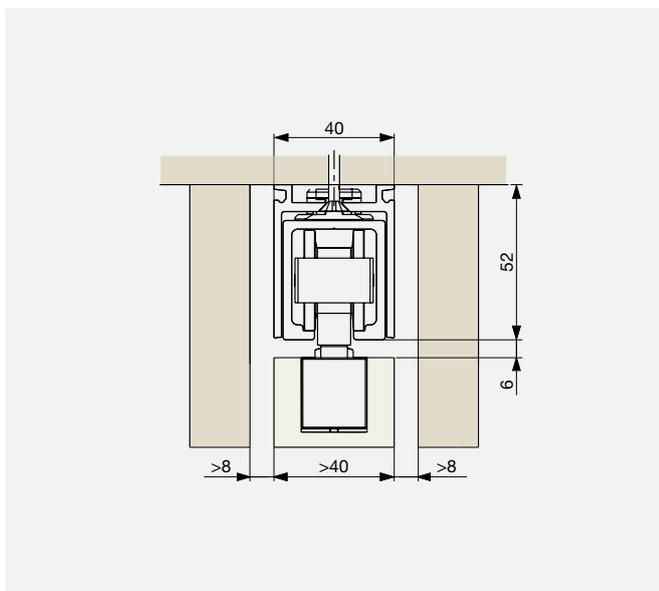
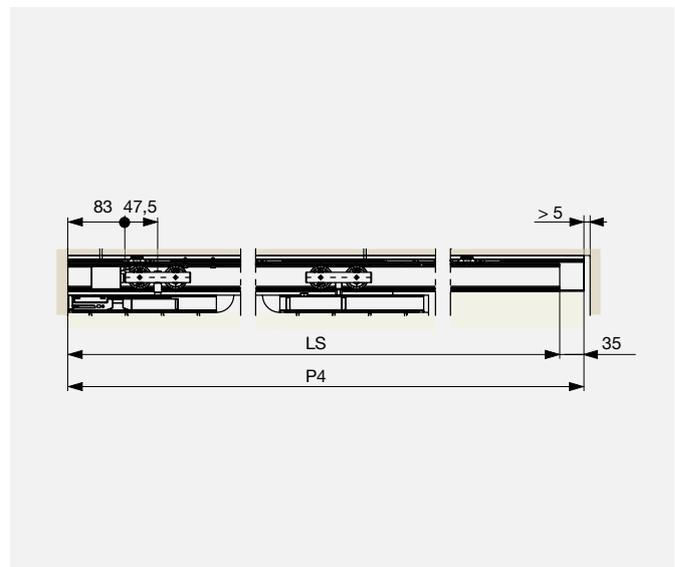
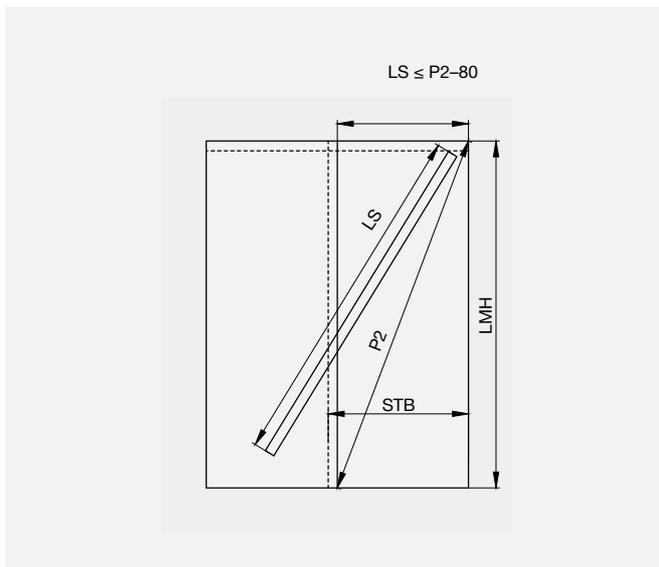

- Elokirano srebrno, prethodno izbušeno, s bajonetom

Duljina [mm]	Kod
2000	F004743

# Riex ES25

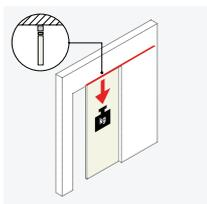

- Sustav za unutarnja klizna vrata
- Nosivost 100 kg po vratima
- Glatka i tiha funkcija



## ⊕ Riex ES25 Okov bez Soft-Close



- Bez soft-close, težina maks.100 kg

Tip	Kod
Set za 1 vrata	F003347

## ⊕ Riex ES25 Dvostrano Soft-Close zatvaranje



- Širina vrata min. 550 mm
- Set za 1 vrata

Kapacitet	Kod
60 kg	F003348
80 kg	F003349

Soft-close verzija zahtijeva širina vrata min., 550 mm. Širina vrata trebala bi biti preko 40 % visine za stabilnu funkciju mekog zatvaranja bez skakanja.

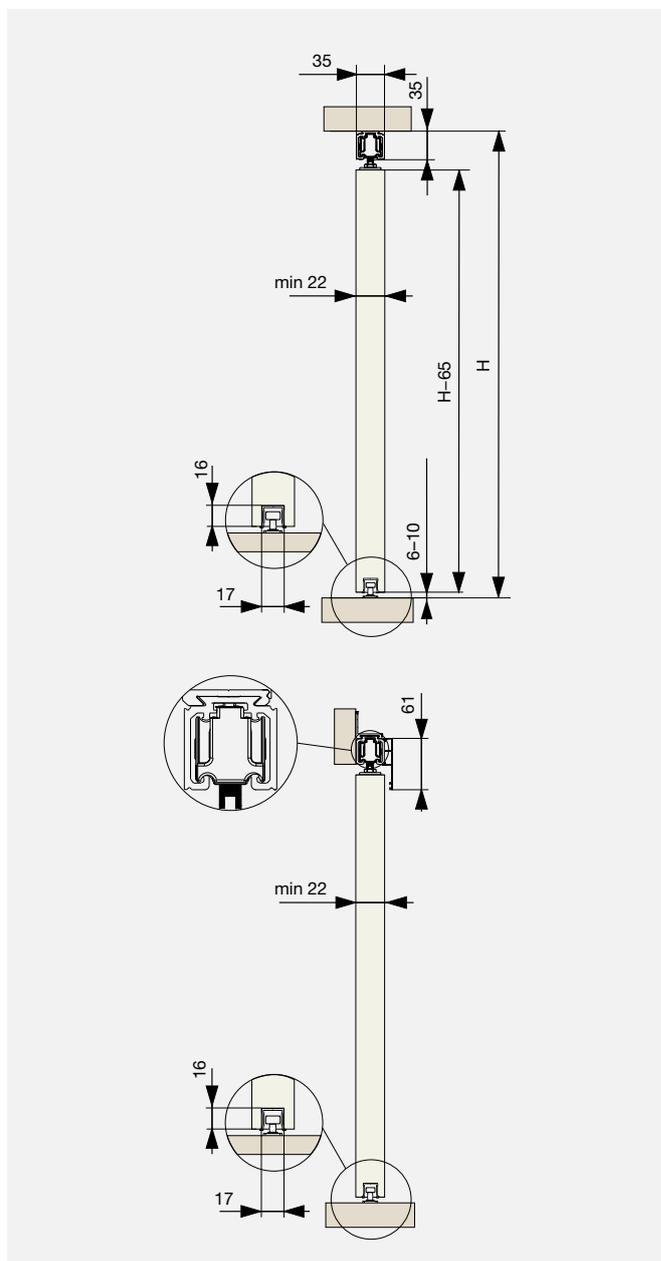

## ⊕ Riex ES25 Gornja vodilica

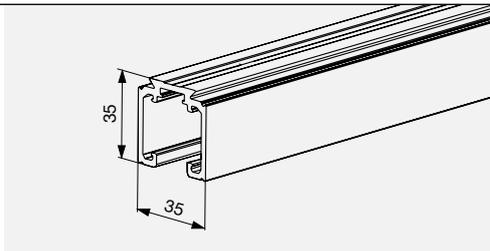

- Crni eloksirani aluminij

Duljina [mm]	Kod
2000	F003352
3000	F003354
4000	F003355

## ⊕ Riex ES25 Pokrovni Profil

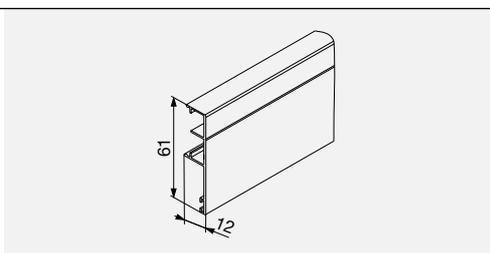

- Crni eloksirani aluminij

Duljina [mm]	Kod
2000	F003358

## ⊕ Riex ES25 Profil Donji

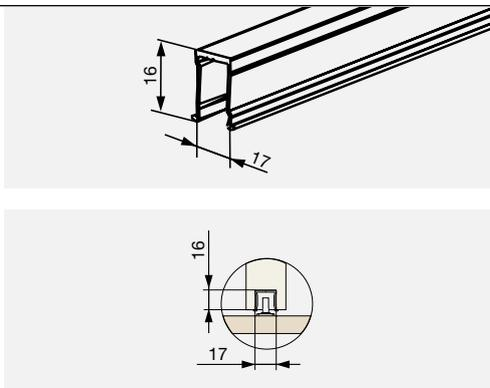

- Crni eloksirani aluminij
- Donja vodilica je uključena u armaturama ES25

Duljina [mm]	Kod
2000	F003356

## ⊕ Riex ES25 Elementi za montažu na zid

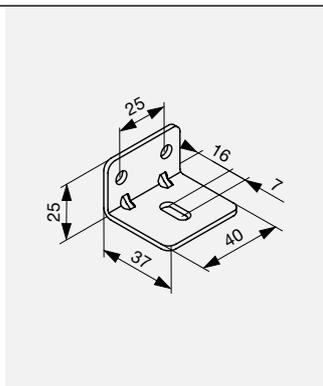

- Kvaliteta funkcija od klizna sustav ovisi na kvaliteta pričvršćivanja, ravne vodilice, ne smije popuštati, klimati se itd.

Tip	Kod
Zid nosač	F005169

Preporučeno korak 40–50 cm [prema težini i čvrstoća zida]:

Dužina vodilice [m]	1,6	2	2,5	3	4
pcs	5	6	7	8	10

# Svjetla i električna oprema

Rasvjeta i električna oprema važna dio svakog interijera. To se odnosi na cijelu prostoriju ili čak na unutrašnjost ormara za namještaj, gdje se osvjetljenjem može upravljati senzorima na vratima namještaja, pokretom ili daljinskim upravljačem. Najčešća izvedba ove namjene je korištenje LED traka, koje nudimo u mnogim izvedbama, uključujući energetske transformatore i ostale dodatke, posebno u sve popularnijoj 24 voltnoj, ali i standardnoj 12 voltnoj verziji. U ovom odjeljku također ćete pronaći druge električne komponente kao što su električne utičnice i druge priključne točke kao što su podatkovni priključci ili punjači za mobilne uređaje za ugradnju u ploče namještaja ili ploče stolova.



● Svjetla i električna oprema	13.3
O svjetlima	13.3
● Sustavi rasvjete 24V	13.5
LED trake 24V Jednobojne	13.6
LED trake 24V Posebno rješenje	13.9
LED trake 24V RGB	13.11
Napajanje LED 24V	13.13
● Sustavi rasvjete 12V	13.17
LED trake 12V	13.17
Napajanje LED 12V	13.19
LED svjetla	13.21
● LED profili	13.23
Nadgradni LED profil	13.25
Ugradnja u LED kutni profil	13.29
LED profil	13.33
● Senzori i pribor	13.37
Senzori i sklopke	13.38
Bežični prekidači	13.41
Razdjelnici i kablovi	13.44
Priključci i pribor	13.46
● Električne utičnice	13.49
● Točke za punjenje	13.65

# Svjetla i električna oprema

## Uvod

Ne možemo zamisliti život bez električne energije koja je neophodna za rasvjetu, komunikaciju i ugodan život. Većinu informacija dobivamo putem vida. Pravilnim odabirom rasvjete možemo utjecati na dojam, percepciju ili raspoloženje. Preporuča se od samog početka organizirati rasvjetu. To olakšava osiguravanje ispravnog položaja komponenti i štedi vrijeme i troškove.

Funkcionalni sustav rasvjete obično uključuje dolje navedene komponente.

### 1 LED trake

#### Opis

- LED diode su montirane na trake od bakrenih žica i emitiraju svjetlost
- Može se rezati u označenom području [linija škarama]
- Opremljen kabelom s MINI konektorom ili lemljenjem [točke na LED traci] ili brzim konektorima
- COB – Posebna vrsta LED trake s nevidljivim točkama, velika gustoća LED dioda tvori kontinuiranu liniju

#### Parametri

- Gustoća – LED diode kom / m, veća gustoća osigurava kontinuiranu liniju svjetla
- Potrošnja energije u W / m
- Napon [12V ili 24V DC] mora biti isti za cijeli sustav
- Stupanj zaštite IP – stupanj zaštite od vode
- Lumen – snaga emitiranog svjetlosnog tijeka
- Temperatura – vidi okvir
- CRI – vidi okvir

#### Manipulacija

- Tijekom manipulacije ne dirajte diode, nemojte savijati traku pod ostrim kutom
- Točan polaritet je neophodan jer obrnuti polaritet neće oštetiti LED diode, ali one neće svijetliti
- Prije rukovanja LED trakama, ispraznite statički naboj dodirivanjem uzemljenog predmeta [grijalica, slavina] ili koristite opremu za uzemljenje
- LED trake emitiraju toplinu, koristite LED profile

### 2 LED profila

#### Hlađenje

Neophodno za dugotrajni rad LED traka.

#### Zaštita

Zaštite LED traku od mehaničkih oštećenja.

#### Oblikovati

Može nadopuniti ili poboljšati dojam i / ili estetski izgled.

### 3 LED napajanje [LED driveri]

LED svjetla trebaju napajanje odgovarajućeg napona

#### Prednosti naših LED transformatora:

- Opremljen je kabelom s utikačem koji omogućuje rukovanje i nekvalificiranim osobama

- Visoki faktor snage [učinkovitost], niska potrošnja u stanju mirovanja, prema najnovijim EU zahtjevima, bez treperenja i stroboskopskog efekta

Za odabir odgovarajućeg upravljačkog programa za vaše potrebe napajanja, pogledajte str. 13.16.

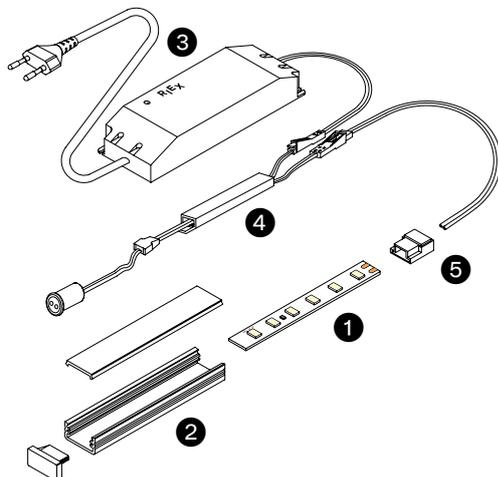

### 4 Senzori i sklopke

#### Senzor vrata

Upalite svjetla kada vrata su otvorena, preporučuje se za ormare u tamnijim prostorima.

#### Senzor pokreta

Za uključivanje, uključuje se valom iza senzora, beskontaktno, higijensko rješenje.

#### PIR senzor

Uključite svjetla ako otkrije kretanje [unutar 1–3 m].

#### Bežični senzor

Samostalna instalacija senzora, do 10 m od kontrolera, omogućuje kombinaciju više senzora ili regulatora.

#### WiFi

Upravljaite svjetlima svojim pametnim telefonom.

Snaga svjetala spojenih na senzor ne smije prelaziti snagu senzora.

### 5 Pribor

Uz razne dodatke montaža je brža i lakša. Razdjelnici, brze spojnice,

kabli, terminali komuniciraju sa senzorima i pogonskim programima.

## Parametri

Objašnjenje parametara danih za svjetla.

## Napetost

U našoj ponudi dostupne su opcije od 24V i 12V. Preporučujemo 24V, pogledajte usporedbu LED trake:



## 24V

- + Nova tehnologija visoke učinkovitosti
- + Popularno rješenje za osvjetljavanje namještaja
- + Veća maksimalna snaga
- + Mali gubitak energije
- + Veće duljine LED traka
- + Manji pad ekspozicije [na daljinu]
- Duži moduli za rezanje

## 12V

- + Podijeljeno u prošlosti, tako da možete kombinirati staro i novo svjetlo
- + Kraći rezni moduli
- Niža maksimalna snaga
- Veća mrlja rasvjete
- Obično starija tehnologija s manje učinkovitosti

## CRI

Ovaj važan parametar pokazuje koliko točno izvor svjetlosti reproducira prirodno svjetlo. Naše svjetiljke imaju CRI Ra viši od 80. Ovo je najniža granica

za poslovne i stambene prostore. U ponudi imamo i svjetiljke s CRI Ra indeksom većim od 90 koje daju vrlo prirodno svjetlo.



⊙ CRI Ra 70



⊙ CRI Ra 80



⊙ CRI Ra 90

## Preporučeni minimalni luks

TVrijednosti ispod su minimalne preporučene vrijednosti, tamne

okolina smanjuje refleksiju i utječe na izmjerene vrijednosti.



20–50

50–100

100–150

250–500

500–1000

Hodnik / javna površina

Spavaća soba / dnevni boravak

Kuhinja / radni prostor

Radni prostor u kuhinji / inspekciji / radionici

Pregled izložbenog prostora / detaljan pregled

## Temperatura svjetlosti

Kod LED dioda možete birati temperaturu svjetla i time utjecati na dojam.

Naša preporuka:

Svjetlo Boja	Oklo	Opis	Prikladan za
Topla bijela	3000	Ugodno i opuštajuće	Spavaća soba, dječja soba
Neutralna bijela	4000	Blago intenzivno	Dnevna soba, kuhinja, soba za učenje
Hladna bijela	6000	Intenzivno	Soba za radno okruženje



● Topla bijela ~ 3000 K



○ Neutralna bijela ~ 4000 K



● Hladna bijela ~ 6000 K

## Lumen

Jedinica svjetlosnog tijeka. Označava intenzitet svjetlosti koju emitira izvor svjetlosti. Označava učinkovitost izvora [lumena po vatu].

## Lux

Pokazuje vrijednost svjetlosnog tijeka na površini [Lux = Lumen / m<sup>2</sup>]. Smanjuje se s povećanjem udaljenosti od izvora svjetlosti i kuta zračenja.

## Položaj

Pravilno postavljena rasvjeta ne bi smjela blještati, stoga je preporučljivo ugraditi LED diode u profil koji je postavljen na način da LED diode ne blješte. Ne ciljajte

izravno u oči. Vodite računa i o položaju u kojem sjedite ili ležite jer samo u tom slučaju ponekad može doći do blještanja.



# Sustavi rasvjete 24V

24V ima nekoliko prednosti u električnim uređajima:

- Siguran niski napon
- Daju više snage od 12V LED traka
- Manji pad izloženosti, osobito na dužim linijama
- Visoka kvaliteta, preporuka za dugoročno rješenje
- Ispunjavanje novih EU zahtjeva za ERP



13



## ⊕ Riex EL51 Snaga 6 W / m

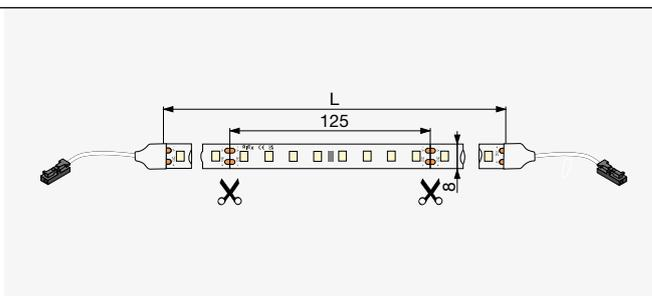

⊙ L = 5 m / 30 m, modul 8 dioda

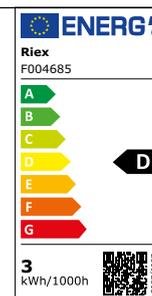

5 godina jamstva

- LED traka manje snage
- Visoka učinkovitost
- Kabeli s MINI konektorima s obje strane za bržu upotrebu

Temperatura bijele boje	Role 5 m	Role 30 m	Temperatura [K]	Svjetlosni tijek [Lm / m]	Diode / m	CRI Ra
Topla	F004685	F004688	3000			
Neutralna	F004686	F004689	4000	1000	64	90
Hladno	F004687	F004690	6000			

⊙ Role od 30 m za industrijsku upotrebu – moraju se rezati prije uključivanja napajanja [maksimalno 5 m]!

## ⊕ Riex EL52 Snaga 6 W / m IP54

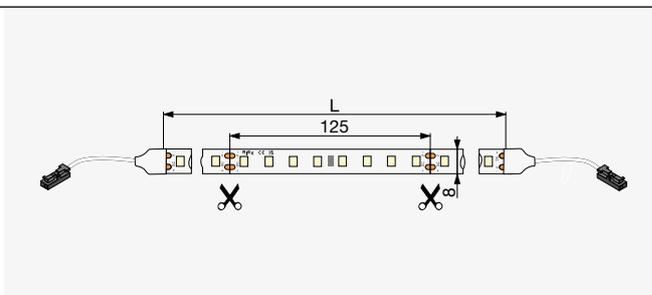

⊙ L = 5 m / 30 m, modul 8 dioda

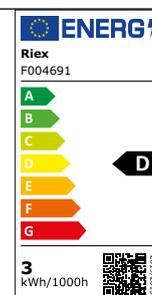

3 godine jamstva



IP54  
Otpornost

- LED traka srednje manje snage
- Zaštićen silikonskim gelom – vodootporan\*
- Silikonski gel mijenja svojstva i boju svjetla i smanjuje rasipanje topline [ne preporučuje se za dugotrajno osvjetljenje]

Temperatura	Bijele boje 5 m	Temperatura [K]	Svjetlosni tijek [Lm / m]	Diode / m	CRI Ra
Topla	F004691	3000			
Neutralno	F004692	4000	1000	64	90

Napajanje – vidi str. 13.14–13.16.

Produljeno jamstvo uvjetovano je ugradnjom u aluminijske profile i korištenjem preporučenih izvora napajanja.

\* LED trake presvučene silikonom ne preporučuju se za trajno vlažne prostorije.

## ⊕ Riex EL55 Snaga 12 W / m

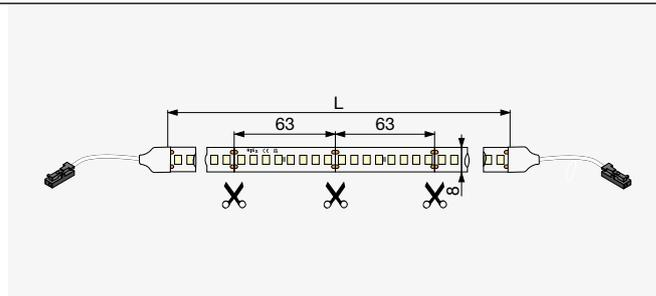

⊕ L = 5 m / 30 m, modul 8 dioda

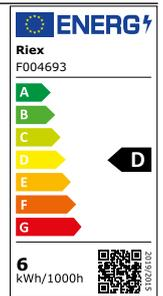

5 godina  
jamstva

- LED traka velike snage
- Velika količina dioda omogućuje puniju liniju svjetla i nevidljive svjetlosne točke s opalno / crnim pokrovima na profilima na str. 13.25–13.36 sati
- Visoka učinkovitost
- Kabeli s MINI konektorima s obje strane za bržu upotrebu

Temperatura bijele boje	Rola 5 m	Rola 30 m	Temperatura [K]	Svjetlosni tijek [Lm / m]	Diode / m	CRI Ra
Topla	F004693	F004696	3000			
Neutralna	F004694	F004697	4000	1600	128	90
Hladno	F004695	F004698	6000			

⊕ Role od 30 m za industrijsku upotrebu – moraju se rezati prije uključivanja napajanja [maksimalno 5 m]!

## ⊕ Riex EL56 Snaga 12 W / m IP54

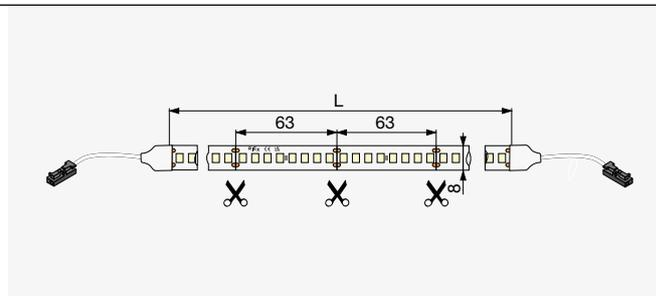

⊕ L = 5 m, modul 8 dioda

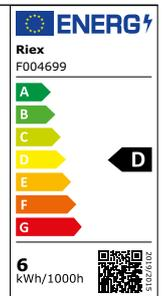

3 godine  
jamstva



IP54  
Otpornost

- LED traka velike snage
- Velika količina dioda omogućuje puniju liniju svjetla i nevidljive svjetlosne točke s opalno / crnim pokrovima na profilima na str. 13.25–13.36 sati
- Zaštićen silikonskim gelom – vodootporan\*\*
- Silikonski gel mijenja svojstva i boju svjetla i smanjuje rasipanje topline [ne preporučuje se za dugotrajno osvjetljenje]
- Kabeli s MINI konektorima s obje strane za bržu upotrebu

Temperatura bijele boje	Rola 5 m	Temperatura [K]	Svjetlosni tijek [Lm / m]	Diode / m	CRI Ra
Topla	F004699	3000			
Neutralna	F004700	4000	1600	128	90

Napajanje – vidi str. 13.14–13.16.

Produljeno jamstvo uvjetovano je ugradnjom u aluminijske profile i korištenjem preporučenih izvora napajanja.

\* LED trake presvučene silikonom ne preporučuju se za trajno vlažne prostorije.

## ⊕ Riex EL58 Snaga 16 W / m

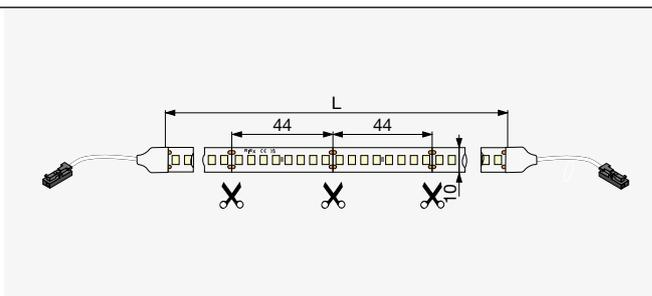

⊕ L = 5 m, modul 8 dioda

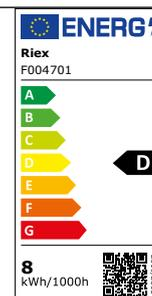

5 godina jamstva

- vrlo velike snage
- Velika količina dioda omogućuje puniju liniju svjetla i nevidljive svjetlosne točke s opalno / crnim pokrovima na profilima na str. 13.25–13.36 sati
- Visoka učinkovitost
- Kabeli s MINI konektorima s obje strane za bržu upotrebu

Temperatura bijele boje	Role 5 m	Temperatura [K]	Svjetlosni tijek [Lm / m]	Diode / m	CRI Ra
Topla	F004701	3000			
Neutralna	F004702	4000	2300	176	90
Hladna	F004703	6000			

## ⊕ Riex EL61 Snaga 9,6 W / m Uska LED traka 4 mm

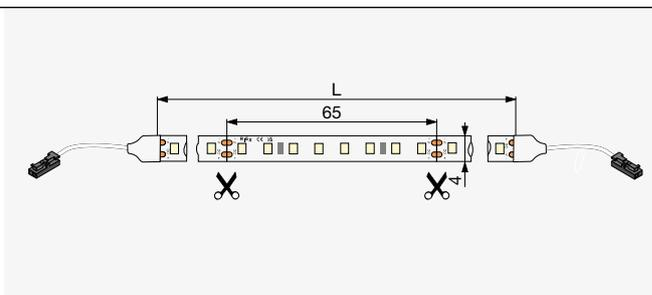

⊕ L = 5 m, modul 8 dioda

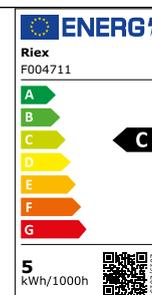

5 godina jamstva

- Uska LED traka srednje snage
- Prikladno za tanku ugradnju
- Velika količina dioda omogućuje puniju liniju svjetla i nevidljive svjetlosne točke s opalno / crnim pokrovima na profilima na str. 13.25–13.36 sati
- Visoka učinkovitost
- Kabeli s MINI konektorima s obje strane za bržu upotrebu

Temperatura bijele boje	Role 5 m	Temperatura [K]	Svjetlosni tijek [Lm / m]	Diode / m	CRI Ra
Topla	F004711	3000			
Neutralna	F004712	4000	1700	128	90

Napajanje – vidi str. 13.14–13.16.

Produljeno jamstvo uvjetovano je ugradnjom u aluminijske profile i korištenjem preporučenih izvora napajanja.

## ⊗ Riex EL63 Snaga 5 W / m CC LED traka za dugu liniju

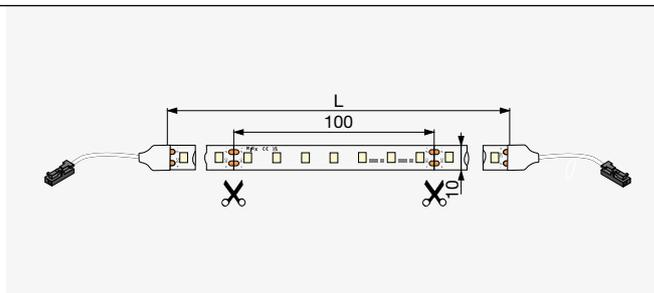

⊗ L = 15 m, modul 7 dioda



3 godine  
jamstva

- Duga linijska LED traka srednje manje snage
- LED traka s tehnologijom konstantne struje koja omogućuje izradu jedne trake cijele duljine
- do 15 m bez smanjenja intenziteta osvjetljenja.
- Visoka učinkovitost
- Kabeli s MINI konektorima s obje strane za bržu upotrebu
- Puna duljina od 15 metara može se spojiti na transformator [80W ili više]

Temperatura bele barve	Rola 15 m	Temperatura [K]	Svetlobni tijek [Lm / m]	Diode / m	CRI Ra
Topla	F004713	3000	540	70	80
Neutralno	F004714	4000	570		

## ⊗ Riex EL71 Snaga 14,4 W / m COB

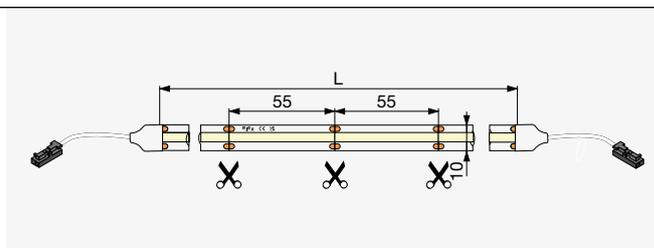

⊗ L = 5 m, modul 21 dioda

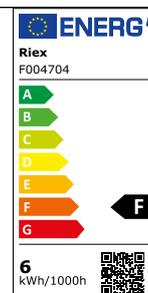

5 godina  
jamstva

- COB\* LED trake
- Nevidljive diode stvaraju kontinuiranu liniju svjetlosti
- Visoka učinkovitost
- Kabeli s MINI konektorima s obje strane za bržu upotrebu

\* COB – Chip on Board – LED diode se montiraju izravno na tiskanu ploču s minimalnim razmakom

Temperatura bijele boje	Role 5 m	Temperatura [K]	Svetlosni tijek [Lm / m]	Diode / m	CRI Ra
Topla	F004704	3000			
Neutralna	F004705	4000	1000	378	90
Hladna	F004706	6000			

Napajanje – vidi str. 13.14–13.16.

Produljeno jamstvo uvjetovano je ugradnjom u aluminijske profile i korištenjem preporučenih izvora napajanja.

## ⊕ Riex EL91 Snaga 6 + 6 W / m Dvobojna LED traka

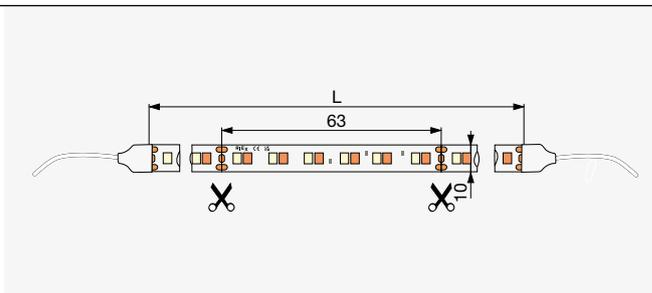

⊕ L = 5 m, modul 15 dioda

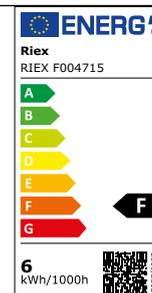

3 godine  
jamstva

- Dvostruke LED trake
- Boja svjetla se može podesiti od tople bijele do neutralne bijele – potreban je upravljač
- Preporučeni kontroler – WIFI, str. 13.43
- Visoka učinkovitost

Temperatura bijele boje	Role 5 m	Temperatura [K]	Svjetlosni tijek [Lm / m]	Diode / m	CRI Ra
Toplo + neutralno	F004715	3000–4000	640	240	80

⊕ Dvostruka LED traka treba odgovarajući upravljač. Preporučeni Wifi kontroler F004718.

## ⊕ Riex EL93 Snaga 12 W / m DIM za grijanje

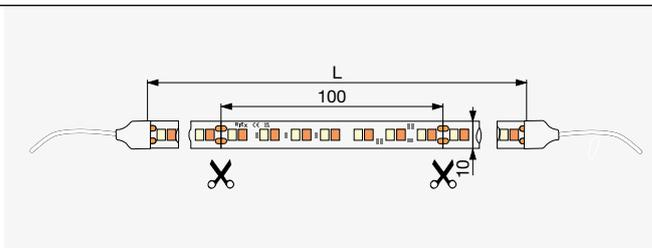

⊕ L = 5 m, modul 14 dioda

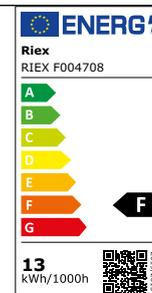

5 godina  
jamstva

- LED trake s posebnom funkcionalnošću
- Svjetlost postaje toplija kako se smanjuje na niži intenzitet
- Rad sa standardnim dimmerom za jednu boju
- Slijedi prirodne ljudske cikluse [manje svjetla ujutro i toplije navečer].

Temperatura bijele boje	Role 5 m	Temperatura [K]	Svjetlosni tijek [Lm / m]	Diode / m	CRI Ra
Toplo do neutralno	F004708	2700–4000	1300	140	90

Napajanje – vidi str. 13.14–13.16.

Produljeno jamstvo uvjetovano je ugradnjom u aluminijske profile i korištenjem preporučenih izvora napajanja.

## ⊕ Riex EL94 Snaga 9,6 W / m Fleksibilne silikonske trake

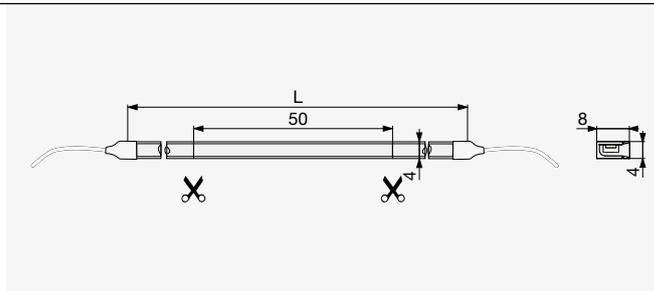

⊙ L = 5 m



3  
3 godine  
jamstva

IP65  
Otpornost

- Fleksibilne silikonske LED trake
- Za dizajn, instalacija u tanki utor
- IP65 [mora se koristiti dodatna silikonska brtva na krajevima]
- Minimalni radijus 60 mm

Svijetle boje	Role 5 m	Temperatura [K]	Svjetlosni tijek [Lm / m]	Diode / m	CRI Ra
Topla bijela	F004716	3000	1400	140	80
Nevtralna bijela	F004717	4000			

## ⊕ Riex EL81 Snaga 14 W / m RGB

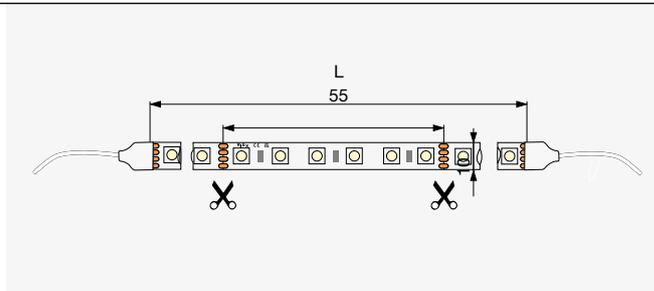

⊙ L = 5 m, modul 6 dioda

3  
3 godine  
jamstvo

- RGB LED trake
- 3-u-1 LED čip može stvoriti širok raspon boja miješanjem crvenog, zelenog i plavog svjetla
- Za ambijentalno svjetlo – ne preporučuje se za normalno osvjetljenje
- Nije definiran kao „izvor svjetlosti“ prema UREDBI [EU] 2019/2015

Svijetle boje	Role 5 m	Temperatura [K]	Svjetlosni tijek [Lm / m]	Diode / m	CRI Ra
RGB	F004709	N/A	N/A	60	N/A

⊙ RGB LED traka treba RGB kontroler. Preporučeni Wifi kontroler F004718.

Napajanje – vidi str. 13.14–13.16.

Produljeno jamstvo uvjetovano je ugradnjom u aluminijske profile i korištenjem preporučenih izvora napajanja.

## ⊕ Riex EL83 Snaga 21 W / m RGB

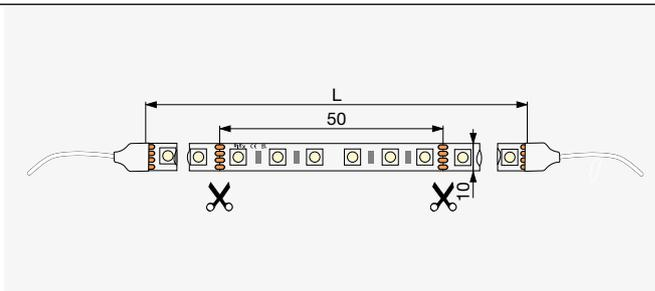

3 godine  
jamstvo

⊕ L = 3 m, modul 6 dioda

- RGB LED trake
- 3-u-1 LED čip može stvoriti širok raspon boja miješanjem crvenog, zelenog i plavog svjetla
- Za ambijentalno svjetlo – ne preporučuje se za normalno osvjetljenje
- Nije definiran kao „izvor svjetlosti“ prema UREDBI [EU] 2019/2015
- Velika količina dioda omogućuje punu liniju svjetlosnih – nevidljivih dioda [samo određeni profili]

Svijetle boje	Role 3 m	Temperatura [K]	Svjetlosni tijek [Lm / m]	Diode / m	CRI Ra
RGB	F004710	N/A	N/A	120	N/A

⊕ RGB LED traka treba RGB kontroler. Preporučeni Wifi kontroler F004718.

## ⊕ Riex EL85 Snaga 14 W / m RGB COB

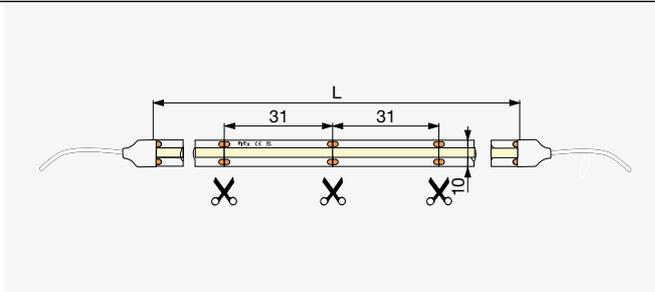

3 godine  
jamstva

⊕ L = 5 m, modul 24 diode

- RGB COB\* LED trake
- 3-u-1 LED čip može stvoriti širok raspon boja miješanjem crvenog, zelenog i plavog svjetla
- Nevidljive diode stvaraju kontinuiranu liniju svjetlosti
- Za ambijentalno svjetlo – ne preporučuje se za normalno osvjetljenje
- Nije definiran kao „izvor svjetlosti“ prema UREDBI [EU] 2019/2015

\* COB – Chip on Board – LED diode se montiraju izravno na tiskanu ploču s minimalnim razmakom

Svijetle boje	Role 5 m	Temperatura [K]	Svjetlosni tijek [Lm / m]	Diode / m	CRI Ra
RGB	F004707	N/A	N/A	768	N/A

⊕ RGB LED traka treba RGB kontroler. Preporučeni Wifi kontroler F004718.

Napajanje – vidi str. 13.14–13.16.

Produljeno jamstvo uvjetovano je ugradnjom u aluminijske profile i korištenjem preporučenih izvora napajanja.

# Napajanje LED 24V

Naša serija 24V LED transformatora izrađena je od visoke kvalitete kvalitetne komponente koje

osiguravaju dugotrajnu izvedbu. Visoka učinkovitost, niska potrošnja i rad bez treperenja naš su standard.





## ⦿ Riex EL25 LED napajanje 24V



- Dizajniran za napajanje LED svjetala
- Ugodan dizajn
- Kabel za napajanje 1,5 m sa utikačem
- Izlazni kabel 1,5 m sa MINI konektor\*
- Jamstvo 5 godina\*\*



5 godina  
jamstva

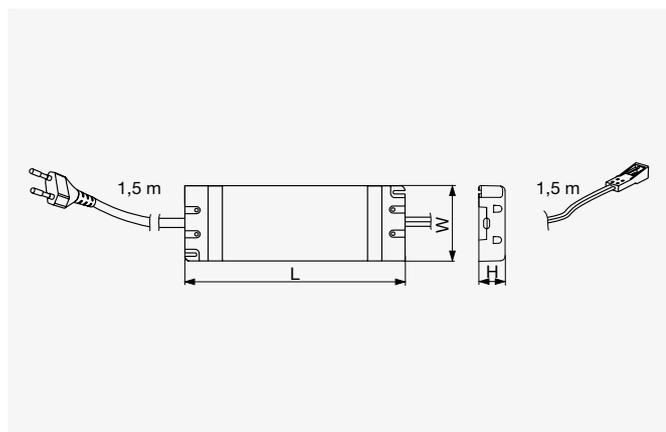

**Izbor i instalacija transformatora:**  
Pogledajte podatke s tablicom na str. 13.16.

Ulazni utikač	Napajanje [W]	Izlaz kabel w. MINI	Kod	Trenutni [A]	Velikost L × W × H [mm]
EU 	15	1	F004347	0,625	103 × 36 × 17
	30	1	F004350	1,25	
	50	1	F004352	2,1	
	75	2	F004353	3,125	
	100*	2	F004354	4,16	
UK 	30	1	F004357	1,25	160 × 58 × 18
	50	1	F004358	2,1	
	75	2	F004359	3,125	

\* MINI konektori ne mogu opteretiti više od 60 W. Jače žice moraju se spojiti izravno na izlaznu priključnu kutiju. Ožičenje mora izvesti ovlaštena osoba.

\*\* Produženo jamstvo vrijedi uz uvjet da je uređaj montiran u skladu s uputama, bez preopterećenja i s dovoljnom ventilacijom. Napon napajanja mora biti u skladu sa standardom EN 60038, šteta zbog neodgovarajućeg mrežnog napona se ne može reklamirati.

## Ⓞ Riex EL26 LED napajanje 24V IP44



- Dizajniran za napajanje LED svjetala
- Ugodan dizajn
- Jamstvo 5 godina\*
- IP44 – pogodan za kupaonice i slične primjene
- IP44 razvodna kutija uključena u paket
- Kabel 0,2 m sa slobodnim krajevima



5 godina jamstva



IP44  
Otpornost

Ožičenje mora izvesti ovlaštena osoba.

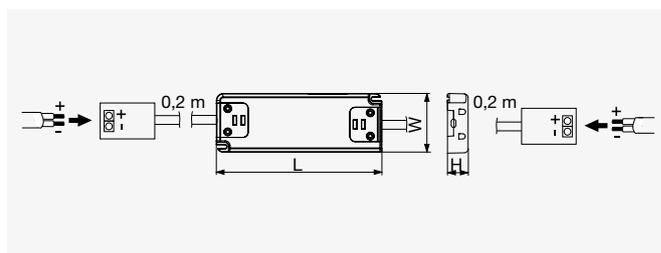

Ulazni utikač	Napajanje [W]	Kod	Trenutno [A]	Veličina L x W x H [mm]
Prikjučna kutija IP44 	20	F004349	0,83	130 x 42 x 17

## Ⓞ Riex EL27 24 V LED napajanje s izravnim izlazom



- Dizajniran za napajanje LED svjetala
- Ugodan dizajn
- Kabel za napajanje 1,5 m sa utikačem
- Kućište s MINI utičnicama za izravnu ugradnju
- Jamstvo 5 godina\*



5 godina jamstva

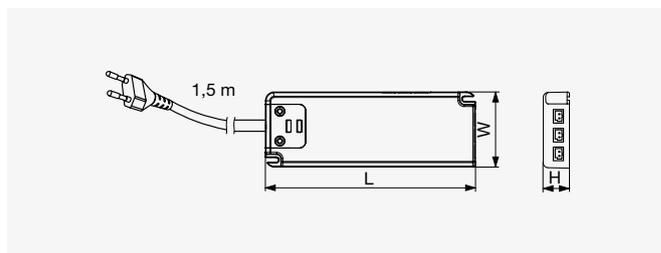

Ⓞ F004351

Ulazni utikač	Napajanje [W]	MINI izlazne utičnice	Kod	Trenutn [A]	Veličina L x W x H [mm]
EU 	15	5	F004348	0,625	128 x 46 x 17
	30	6	F004351	1,25	185 x 63 x 22
UK 	15	5	F004356	0,625	128 x 46 x 17

\* Produženo jamstvo vrijedi ako je ugrađeno prema uputama, bez preopterećenja i s dovoljnom ventilacijom. Napon napajanja mora biti u skladu sa standardom EN 60038, šteta zbog neodgovarajućeg mrežnog napona se ne može reklamirati.

## ⦿ Riex EL28

### LED napajanje 24V 150 W



- Dizajniran za napajanje LED svjetala
- Ugodan dizajn za korištenje u ograničenom prostoru
- Jamstvo 5 godina\*
- Kabel za napajanje 1,5 m sa utikačem
- Izlaz – spojni blok



5 godina  
jamstva

Ožičenje mora izvesti ovlaštena osoba.

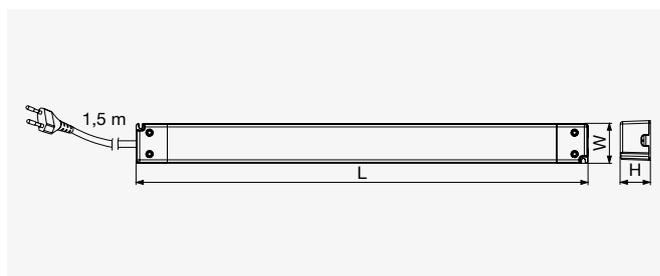

Ulazni utikač	Napajanje [W]	Kod	Trenutn [A]	Veličina L x W x H [mm]
EU 	150	F004355	6,25	360 x 32 x 24

### LED transformator i preporučena duljina LED trake

Izračun potrebne snage [odnosi se na 12V i 24V]:

Minimalna snaga pokretača  $\geq$  duljina LED trake  $\times$  snaga LED trake  $\times$  rezerva snage 10%  
 $DP [W] \geq L [m] \times LP [W / m] \times R 1,1$

Pogonska snaga [W]	15	20	30	50	75	100
Snaga LED trake LP [W / m]			Duljina max. L [m]			
5*	2,7	3,6	5,4	9	13,6	15
6	2,2	3	4,5	9	5	5
9,6	1,4	1,8	2,8	4,7	5	5
12	1,1	1,5	2,2	3,7	5	5
14	0,9	1,2	1,9	3,2	4,8	5
16	0,8	1,1	1,7	2,8	4,2	5
21	0,6	0,8	1,2	2,1	3	x

\* LED traka 5 W / m Riex EL63 sa konstantnom strujom može raditi do duljine od 15 m

Omogućite dovoljnu ventilaciju, nemojte pokrivati, nemojte postavljati blizu izvora topline ili električnih uređaja. Nemojte koristiti duge kabele, postavite vozače blizu svjetala i prekidača.

#### Rezerva snage:

Preporučena rezerva snage je oko 10–20%, a čestim uključivanjem i kontinuiranim radom taj je udio veći.

\* Produženo jamstvo vrijedi ako je ugrađeno prema uputama, bez preopterećenja i s dovoljnom ventilacijom. Napon napajanja mora biti u skladu sa standardom EN 60038, šteta zbog neodgovarajućeg mrežnog napona se ne može reklamirati.

# LED trake 12V

12V je osnovno rješenje.

- Visoka učinkovitost
- Visoka kvaliteta
- Ispunjavanje novih EU zahtjeva za ERP
- Prikladno za kraće dužine

## ⊕ Riex EL41 Snaga 6 W / m

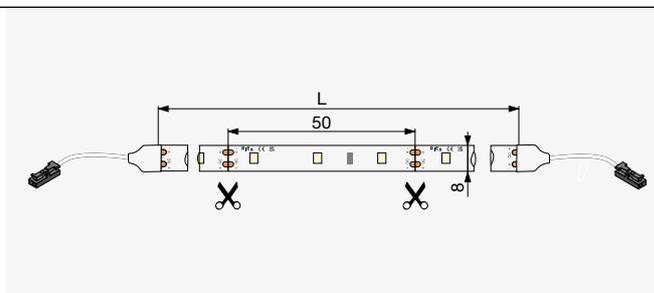

⊙ L = 5 m, modul 3 diode

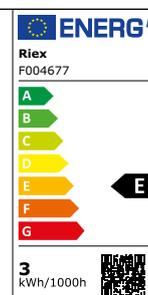

- Osnovna LED traka za dekorativnu rasvjetu
- Kabeli s MINI konektorima s obje strane za bržu upotrebu

Temperatura bijele boje	Rola 5 m	Temperatura [K]	Svjetlosni tijek [Lm / m]	Diode / m	CRI Ra
Topla	F004677	3000	740	60	80
Neutralna	F004678	4000	760		
Hladna	F004679	6000	750		

Napajanje – vidi str. 13.20.

## ⊕ Riex EL42 Snaga 6 W / m IP54

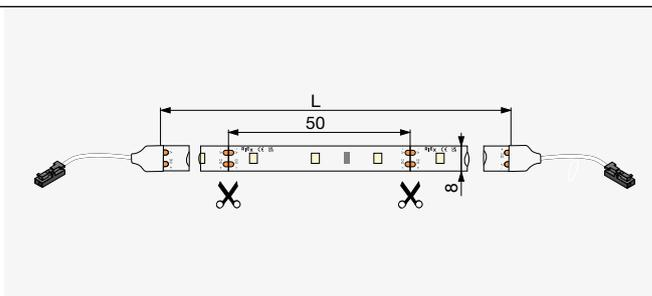

⊕ L = 5 m, modul 3 diode

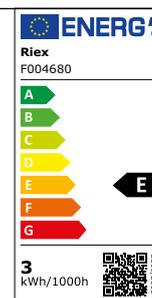

- Osnovna LED traka za dekorativnu rasvjetu
- Kabeli s MINI konektorima s obje strane za bržu upotrebu
- Zaštićen silikonskim gelom – vodootporan\*
- Silikonski gel mijenja svojstva i boju svjetla i smanjuje rasipanje topline [ne preporučuje se za dugotrajno osvjetljenje]

Temperatura bele barve	Rolka 5 m	Temperatura [K]	Svetlobni tijek [Lm / m]	Diode / m	CRI Ra
Topla	F004680	3000	740	60	80
Neutralno	F004681	4000	760		

\* LED trake presvučene silikonom ne preporučuju se za trajno vlažne prostorije.

## ⊕ Riex EL43 Snaga 12 W / m

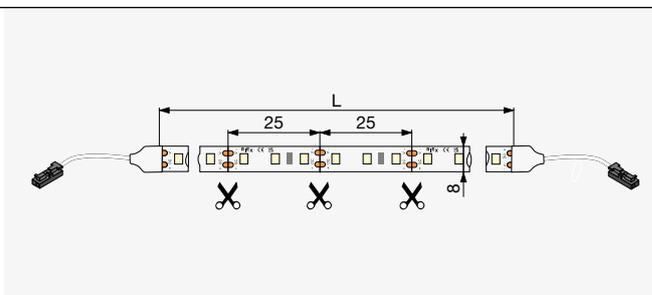

⊕ L = 5 m, modul 3 diodes

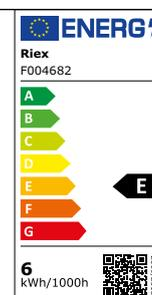

- Srednje snage
- Visoka učinkovitost
- Kabeli s MINI konektorima s obje strane za bržu upotrebu

Temperatura bijele boje	Rolka 5 m	Temperatura [K]	Svjetlosni tijek [Lm / m]	Diode / m	CRI Ra
Topla	F004682	3000	1400	120	80
Neutralna	F004683	4000	1440		
Hladna	F004684	6000	1470		

Napajanje – vidi str. 13.20.

# Napajanje LED 12V

---

Za ispravan rad LED svjetala potreban je odgovarajući napon. Za starije tipove, uobičajeni napon je

12 V. Rasvjeta se može kombinirati s LED trakama i LED svjetlima.



13

## ⊕ Riex EL15 LED napajanje 12V



- Dizajniran za napajanje LED svjetala
- Ugodan dizajn
- Kabel za napajanje 1,5 m sa utikačem
- Izlazni kabel s MINI konektorom\*
- Jamstvo 3 godine\*



3 godine  
jamstva

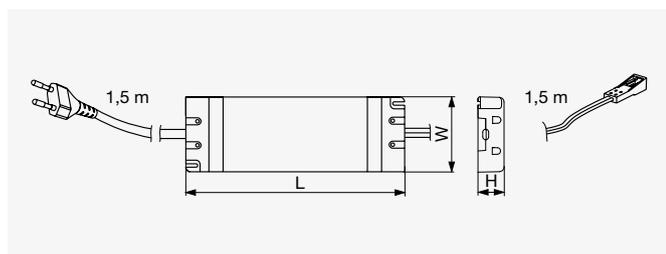

### Proračun potrebne snage:

Snaga pogona [W]  $\geq$  duljina LED trake [m]  $\times$  snaga LED trake [W / m]  $\times$  1,1 [rezerva energije 10%]

### Izbor i instalacija transformatora:

Pogledajte podatke s tablicom na str. 13.16.

U slučaju opterećenja većeg od 50 W po izlazu, mora se spojiti žice izravno na konektor. Ožičenje mora izvesti ovlaštena osoba.

Ulazni utikač	Snaga [W]	Izlazni kabel w. MINI	Kod	Trenutna [A]	Veličina L x W x H [mm]
EU 	30	1	F004343	2,5	147 x 48 x 24
	60	2	F004344	5	185 x 64 x 22
	80	2	F004345	6,67	170 x 57 x 32

## ⊕ Riex EL17 Napajanje LED 12V s izravnim izlazom



- Dizajniran za napajanje LED svjetala
- Ugodan dizajn
- Kabel za napajanje 1,5 m sa utikačem
- Kućište s MINI utičnicama za izravnu ugradnju
- Jamstvo 3 godine\*



3 godine  
jamstva

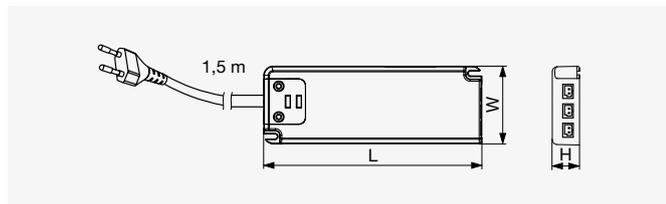

### Izbor i instalacija transformatora:

Pogledajte podatke s tablicom na str. 13.16.

Ulazni utikač	Napajanje [W]	MINI izlazne utičnice	Kod	Trenutna [A]	Veličina L x W x H [mm]
EU 	15	5	F004341	1,25	128 x 46 x 17
	30	6	F004342	2,5	
UK 	30	6	F004886	2,5	184 x 63 x 22

\* Produženo jamstvo vrijedi ako je ugrađeno prema uputama, bez preopterećenja i s dovoljnom ventilacijom. Napon napajanja mora biti u skladu sa standardom EN 60038, šteta zbog neodgovarajućeg mrežnog napona se ne može reklamirati.

# LED svjetla



13



## ⊕ Riex EL50

### LED svjetlo za punjenje s magnetskim držačem



- LED svjetlo sa senzorem
- Zahvaljujući magnetskom držaču, lampu možete jednostavno uzeti i puniti standardnim USB-C punjačem.
- Jednostavna montaža svjetlosnih nosača pomoću 3M dvostrane trake
- Idealno za mjesta bez struje s manje prometa
- Ugrađeni PIR senzor s više načina: stalno osvetljenje / kretanje noću / bilo kakvo kretanje
- 5V punjiva baterija, USB C utičnica, kabel uključen
- Snaga 2 W, topla bijela
- Kućište od aluminija

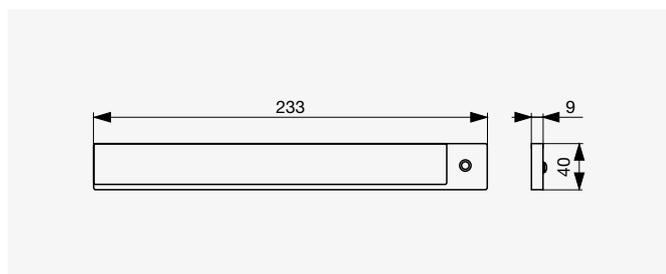

Boja

Kod

Crna

F003518

## ⊕ Riex EL53

### Spot LED svjetlo



○ Bijela

● Crna

- Spot LED svjetlo
- Ugodan dizajn, nevidljive LED diode
- Montaža pomoću 3M dvostrane trake
- Snaga 3 W
- Napon 12V, kabel 1,5 ms na konektor MINI
- Napajanje – str. 13.20

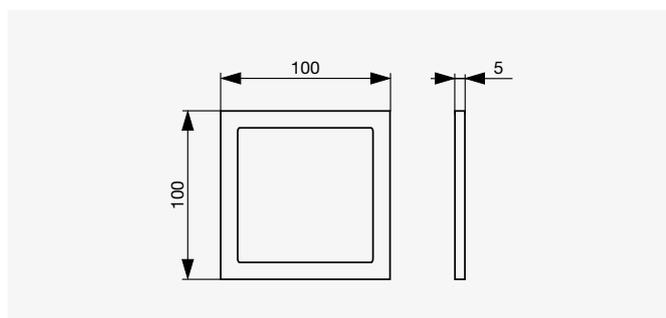
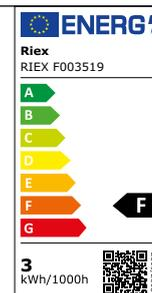

Boje okvira	Temperatura bijele	Kod	Temperatura [K]	Svjetlosni tijek [Lm / m]	CRI Ra
Bijelo	Topla	F003519	3000	139	80
	Neutralno	F003520	4000	162	
Crno	Topla	F003521	3000	139	
	Neutralno	F003522	4000	162	

# LED profili

- Aluminijski profili osiguravaju hlađenje LED trake
- Neophodno za dugotrajni rad LED traka
- Prije postavljanja LED trake očistite i odmastite profile





## LED profili

LED trake stvaraju toplinu, pa je za dugotrajan rad potrebno hlađenje. Druga funkcija LED profila je zaštita od mehaničkih oštećenja.

### Površina

može se dodatno ugraditi, tako da nema potrebe za glodanjem utora ili udubljenja. Izbija na površinu, pa može smetati.

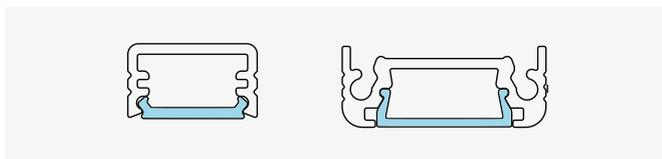

### Kutak

može se dodatno ugraditi, obično se ugrađuje uz zid, svijetli pod kutom da osvijetli cijelu radnu površinu.

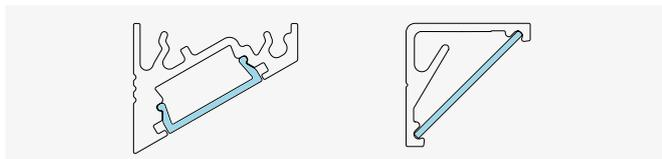

### Montaža

Dizajn treba uzeti u obzir najčešće korišteni tip, koji je ugrađen u ploču i zahtijeva utor. Tip dijagonalnog oblika više je prilagođen potrebama, sa smanjenim odsjajem, u više boja koje su u potpunosti prilagođene zahtjevima kupaca.

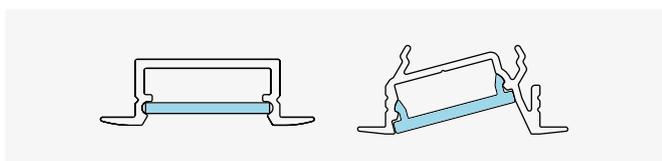

## Korice

Profili obično imaju nekoliko mogućnosti pokrivanja i razlikuju se po apsorpciju i raspršenju svjetla.

### Prozirne korice

Propušta većinu svjetla, ali LED traka je vidljiva i vidljive svjetlosne točke mogu ometati.

### Od opala

što čini LED traku nevidljivom i svjetlost se raspršuje puno više, ali se svjetlosne točke i dalje mogu prepoznati na temelju udaljenosti između LED trake i poklopca i broja LED dioda po metru. S više od 120 LED dioda po metru izgleda kao neprekinuta linija. Opalni premaz apsorbira više svjetla [obično oko 30% svjetla], pa je učinkovitost smanjena.

### Crne korice

dizajnirani su za crne profile, kada je svjetlo isključeno, ne smetaju drugoj boji, izgledaju slično crnom aluminijskom LED profilu. Zbog crnog pigmenta veća je apsorpcija svjetla. Apsorbira više od 50% svjetlosti.

## Kraj

Za završetak profila možete koristiti završne kape koje su dostupne u bojama prema profilu. Pakirano u paru, s rupama za kabel za LED traku.

## Smještaj

Za spajanje se obično koriste spojnice, ljepilo ili dvostrana traka. Neke kopče su vidljive, pa su dostupne u više boja ovisno o boji profila. Prednost stezaljki je laka demontaža, ali LED traku možete zamijeniti i nakon skidanja poklopca.

# Riex EO10 LED profil

- Aluminijski profil za nadgradnu montažu LED trake s priborom

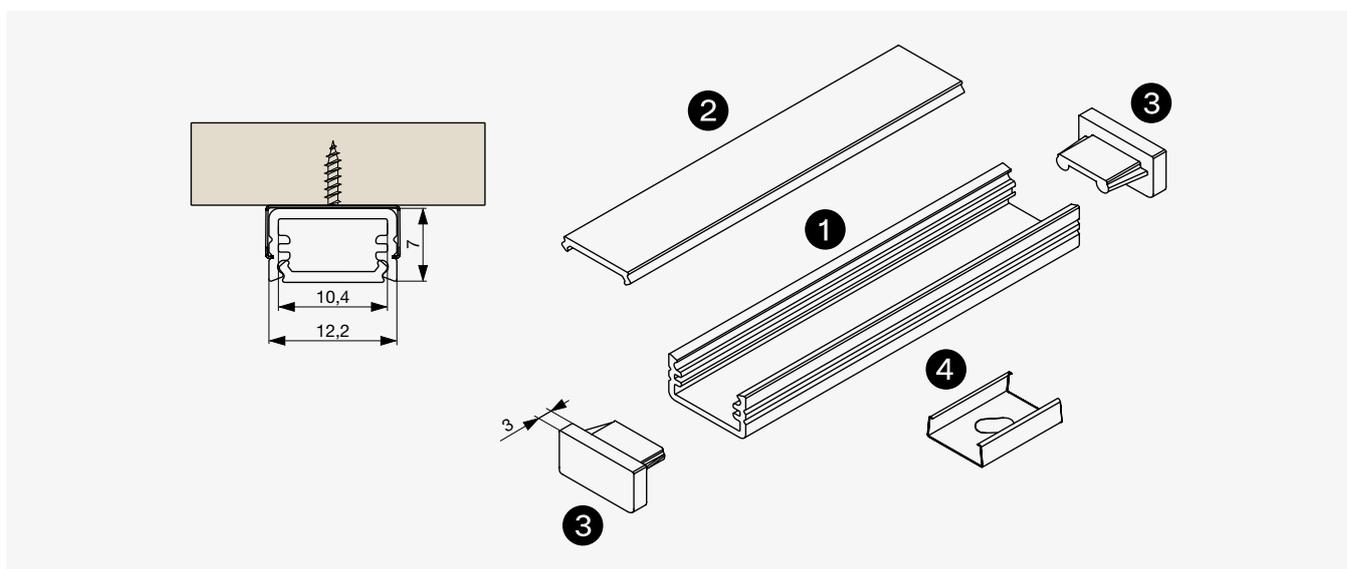

## 1 Riex EO10 LED profil



- Srebrna anodizacija

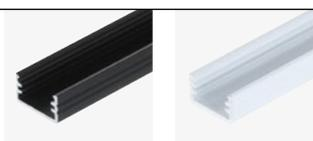

- Crno
- Bijelo

- Tanki aluminijski profil za nadgradnu montažu
- Za LED trake max. širine 8 mm

Boja LED profila	Duljina 2 m
Srebrna anodizacija	F004438
Crna	F004439
Bijela	F004440

## 2 Riex EO10 Pokrov za profile LED



● Opal



○ Prozirno

- Poklopac [difuzor] za profil Riex EO10
- Pritisnite Instaliraj na vrhu
- UV stabilno

Poklopac [difuzor]	Duljina 2 m
Opal	F004487
Prozirna	F004488

Opalni pokrov apsorbira više od 30% svjetlosnog tijeka.

## 3 Riex EO10 završeci



● Sivo



● Crno



○ Bijelo

- EO10 profile

Boja	Kod
Siva	F004467
Crna	F004468
Bijela	F004469

\* Sivi završni slojevi za srebrno anodizirane profile.

## 4 Riex EO10 Isječci



● Izrađen od nehrđajućeg čelika



● Crno



○ Bijelo

- Za profil EO10

Boja	Kod
Nehrđajućeg čelika	F004483
Crna	F004484
Bijela	F004485

\* Kopče od nehrđajućeg čelika za srebrno anodizirane profile.

# Riex E011 LED profil

- Aluminijski profil za nadgradnu montažu LED trake s priborom

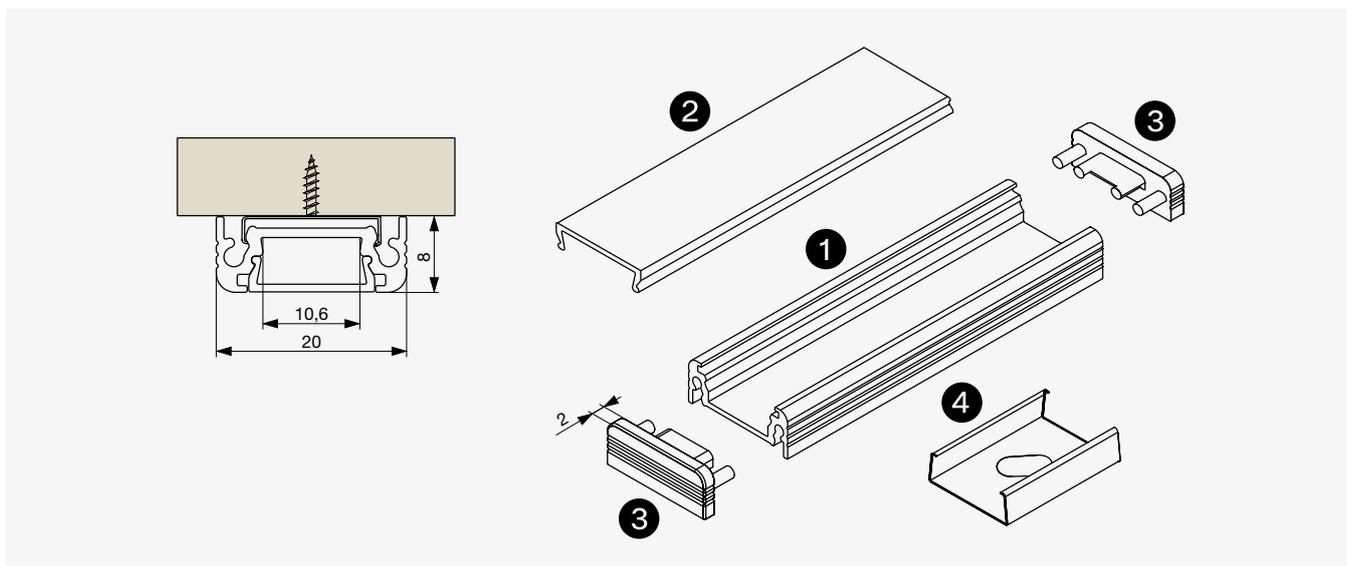

## 1 Riex E011 LED profil



● Anodizacija



● Crno ○ Bijelo

- Profil za nadgradnu ugradnju sa skrivenim stezaljkama
- Za LED trake max. širine 10 mm

Boja LED profila	Duljina 2 m	Duljina 3 m
Srebro eloksirano	F004441	F004442
Crna	F004443	F004444
Bijela	F004445	F004446

## ② Riex EO11 Pokrov za profile LED



● Opal

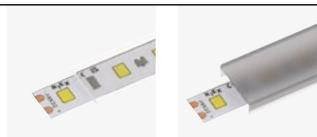

○ Prozirna ● Crna

- Poklopac [difuzor] za profil Riex EO11 / EO20

Pokriti [difuzor]	Duljina 2 m	Duljina 3 m
Opal	F004489	F004492
Transparentan	F004490	F004493
Crno	F004491	F004494

Crni premaz apsorбира više od 50% svjetlosnog tijeka, opalni premaz apsorбира oko 25%.

## ③ Riex EO11 Završeci



● Sivo



● Crno ○ Bijelo

- EO11 profile

Boja	Kod
Siva	F004470
Crna	F004471
Bijela	F004472

\* Sivi završni slojevi za srebrno anodizirane profile.

## ④ Riex EO11 Isječci



● Izrađen od nehrđajućeg čelika

- Parovi objemica za profile EO11

Kod
F004486

01  
02  
03  
04  
05  
06  
07  
08  
09  
10  
11  
12  
13  
14  
15  
16  
17  
18

# Riex EO20 LED profil

- Kutni aluminijski profil za LED trake s priborom

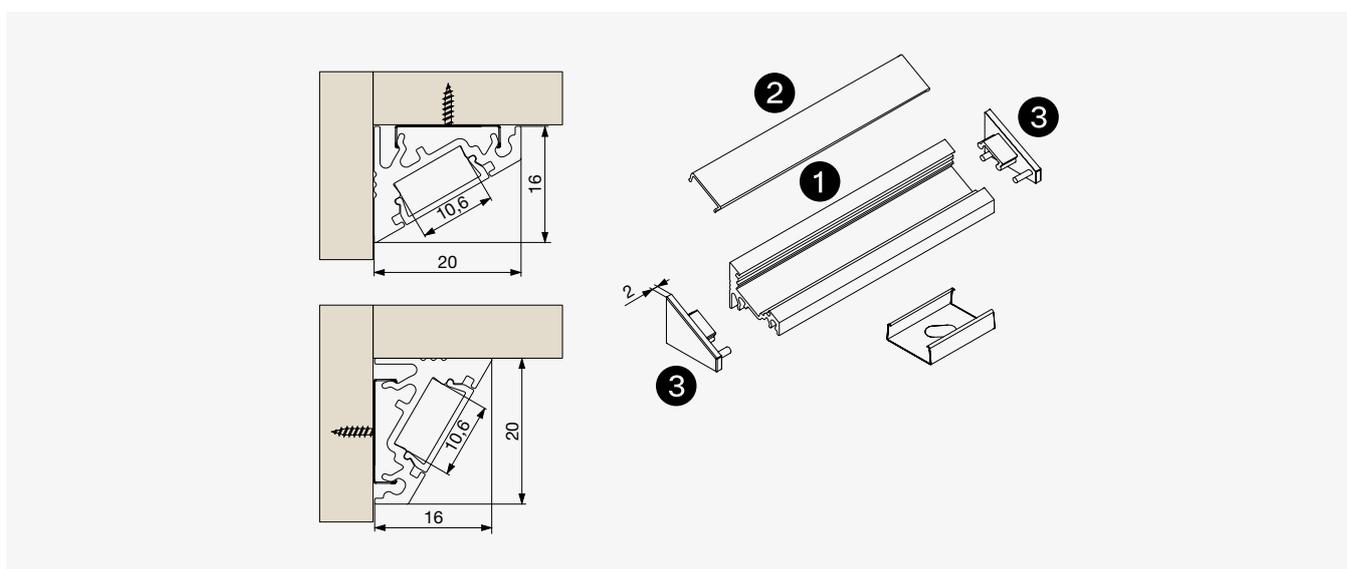

## 1 Riex EO20 LED profil



● Anodizacija srebra

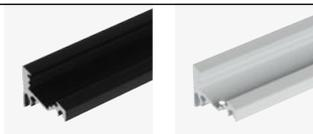

● Crno ○ Bijelo

- Profil za ugradnju u kut sa skrivenim kopčama
- Za LED trake max. širine 10 mm

Boja LED profila	Duljina 2 m	Duljina 3 m
Anodizacija srebra	F004447	F004448
Crno	F004449	F004450
Bijela	F004451	F004452



## ② Riex EO20 Pokrov za profile LED



● Opal



○ Prozirno ● Crno

- Poklopac [difuzor] za profil Riex EO11 / EO20

Pokriti [difuzor]	Duljina 2 m	Duljina 3 m
Opal	F004489	F004492
Transparentan	F004490	F004493
Crno	F004491	F004494

Crni premaz apsorbira više od 50% svjetlosnog tijeka, opalni premaz apsorbira oko 25%.

## ③ Riex EO20 završni slojevi



● Sivo



● Crno ○ Bijelo

- Par krajeva za EO20 profile

Boja	Kod
Siva	F004473
Crna	F004474
Bijela	F004475

\* Sivi završni slojevi za srebrno anodizirane profile.

## ④ Riex EO11 Isječci



● Izrađen od nehrđajućeg čelika

- Parovi objumica za profile EO20

Kod
F004486

# Riex EO22 LED profil

- Kutni aluminijski profil za LED trake s priborom

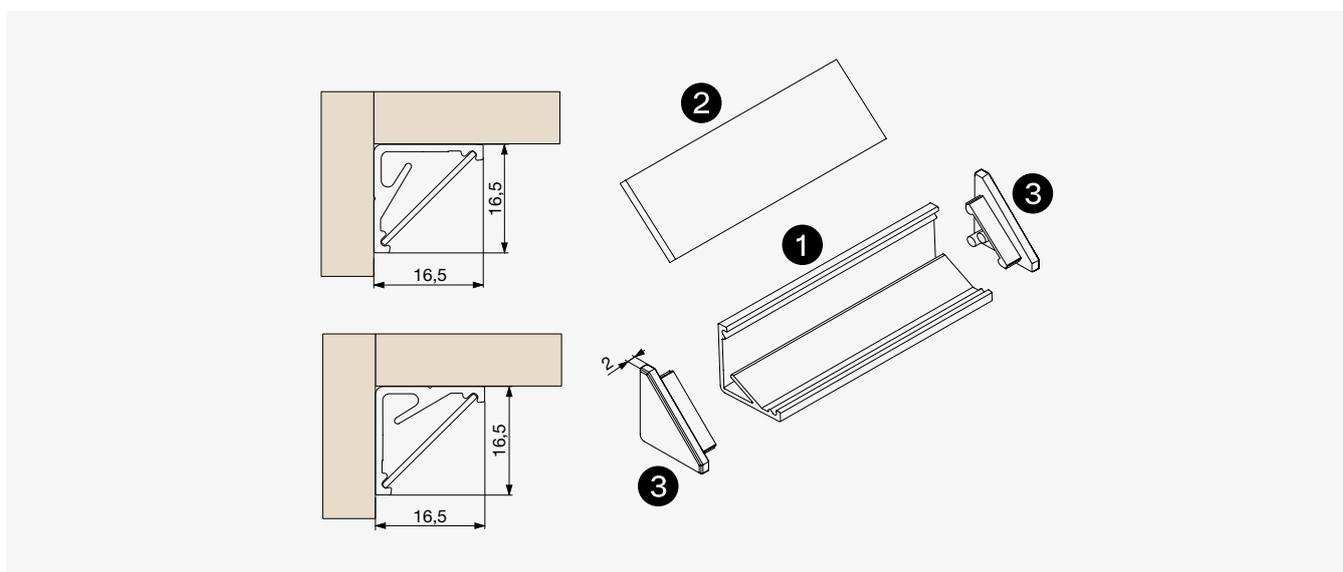

## 1 Riex EO22 LED profil



● Anodizacija srebra

- Profil za ugradnju u kutove
- Velika difuzna površina poklopca omogućuje difuzno svjetlo
- Za LED trake max. širine 8 mm
- Ugradnja ljepljivom ili 3M trakom

Boja LED profila	Duljina 2 m	Duljina 3 m
Srebro eloksirano	F004514	F004515

## ② Riex EO22 Pokrov za profile LED



● Opal



○ Prozirno

- Poklopac [difuzor] za profil EO22

Pokriti [difuzor]	Duljina 2 m	Duljina 3 m
Opal	F004517	×
Transparentan	F004519	F004518

Premaz apsorbira približno 25% svjetlosnog tijeka.

## ③ Riex EO22 završeci



● Sivo

- EO22 profile

Boja	Kod
Siva	F004516

# Riex EO30 LED profil

- Ugrađeni aluminijski profil za LED trake s dodacima

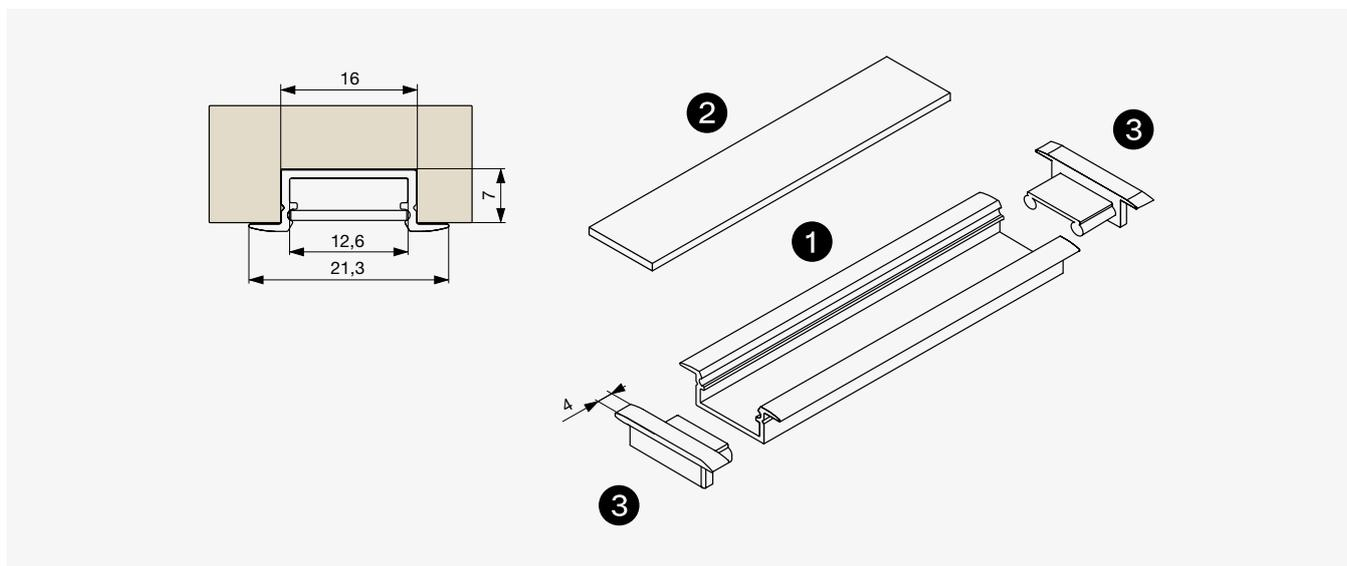

## 1 Riex EO30 LED profil

13



● Anodizacija srebra



● Crno ○ Bijelo

- Profil za unutarnju ugradnju
- Ugradnja pomoću ljepila ili kopči
- Za LED trake max. širine 12 mm

Boja LED profila	Duljina 2 m	Duljina 3 m
Anodizacija srebra	F004453	F004454
Crna	F004455	F004456
Bijela	F004457	F004458

## ② Riex EO30 Pokrov za profile LED



● Opal



○ Prozirno

- Poklopac [difuzor] za profil Riex EO30
- Ugradnja s gornje strane, skidanje sa strane

Pokriti [difuzor]	Duljina 2 m	Duljina 3 m
Opal	F004501	x
Transparentan	F004502	F004503

Premaz apsorbera približno 25% svjetlosnog tijeka.

## ③ Riex EO30 završeci



● Anodizacija srebra



● Crno



○ Bijelo

- Par krajeva za EO30 profile

Boja	Kod
Siva	F004476
Crna	F004477
Bijela	F004478

## ④ Riex EO30 Isječci



● Izrađen od nehrđajućeg čelika

- Parovi objumnica za profile EO30

Kod
F005554

# Riex EO35 LED profil

- Ugrađeni aluminijski profil s bočnim smjerom za LED trake s dodacima

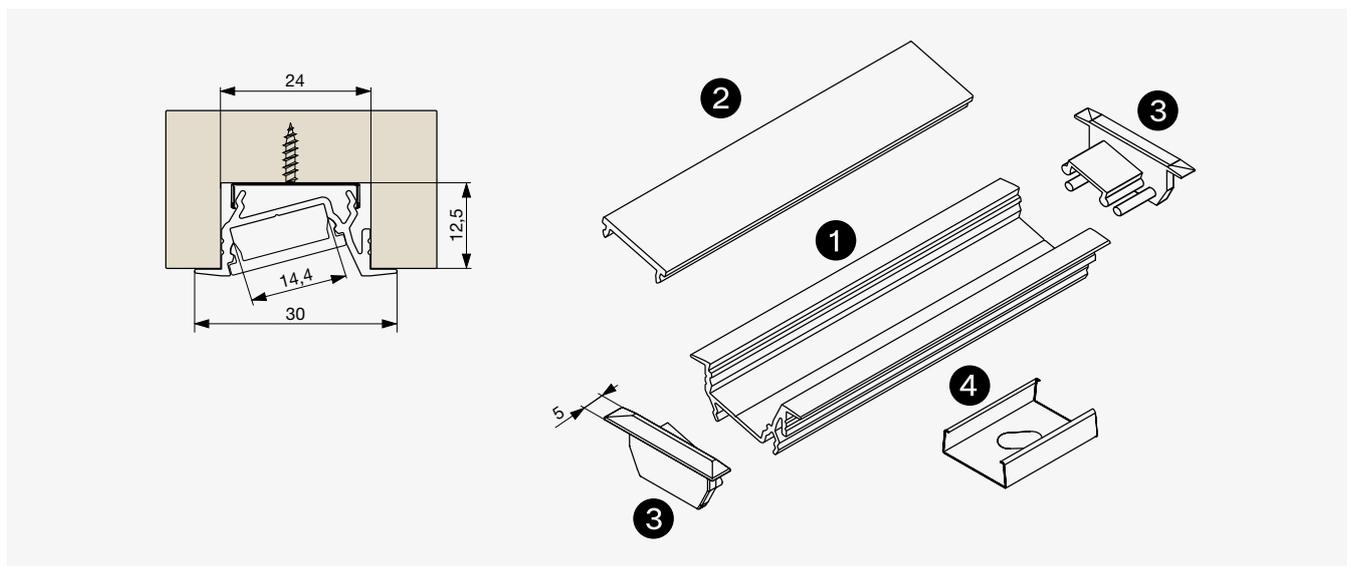

## 1 Riex EO35 LED profil



● Anodizacija srebra

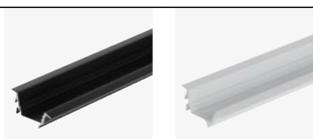

● Crno ○ Bijelo

- Profil za ugradnju pod kutom
- Bočni smjer za sprječavanje odsjaja
- Za LED trake max. širine 12 mm
- Ugradnja pomoću ljepila ili kopči

Boja LED profila	Duljina 2 m	Duljina 3 m
Anodizacija srebra	F004459	F004460
Crno	F004461	F004462
Bijela	F004463	F004464

## ② Riex EO35 Pokrov za profile LED



● Opal



Prozirna     Crna

- Poklopac [difuzor] za profil Riex EO35

Pokriti [difuzor]	Duljina 2 m	Duljina 3 m
Opal	F004495	F004498
Transparentan	F004496	F004499
Crno	F004497	F004500

Crni premaz apsorbira više od 50% svjetlosnog tijeka, opalni premaz apsorbira oko 25%.

## ③ Riex EO35 završeci



● Anodizacija srebra



Crno     Bijelo

- Par krajeva za EO35 profile

Boja	Kod
Siva	F004479
Crna	F004480
Bijela	F004481

## ④ Riex EO35 Isječci



● Izrađen od nehrđajućeg čelika

- Parovi objumica za profile EO35

Kod
F005555

# Senzori i pribor

- Ugradite senzor ergonomski kako biste lakše upravljali svjetlima. Trebao bi biti nadohvat ruke ili raditi automatski.
- Pomoću razdjelnika možete spojiti više svjetala na jedan senzor
- Snaga svih spojenih svjetala ne smije prelaziti maksimalna snaga senzora i napajanja i ostalih komponenti povezanih u seriju.
- Voltaža na svim komponentama mora biti ista, većina naših senzora može podržavati i 12V i 24V.
- Napon svih komponenti mora biti isti, većina naših senzora može raditi i na 12V i na 24V.
- Brze spojnice omogućuju bržu i lakšu montažu. Moguće je brzo spajanje LED traka i kabijela ili oblikovanje kutova.
- Aluminijski profili osiguravaju hlađenje LED trake. Ovo je neophodno za dugotrajni rad LED traka.
- Prije postavljanja LED trake očistite i odmastite profile.

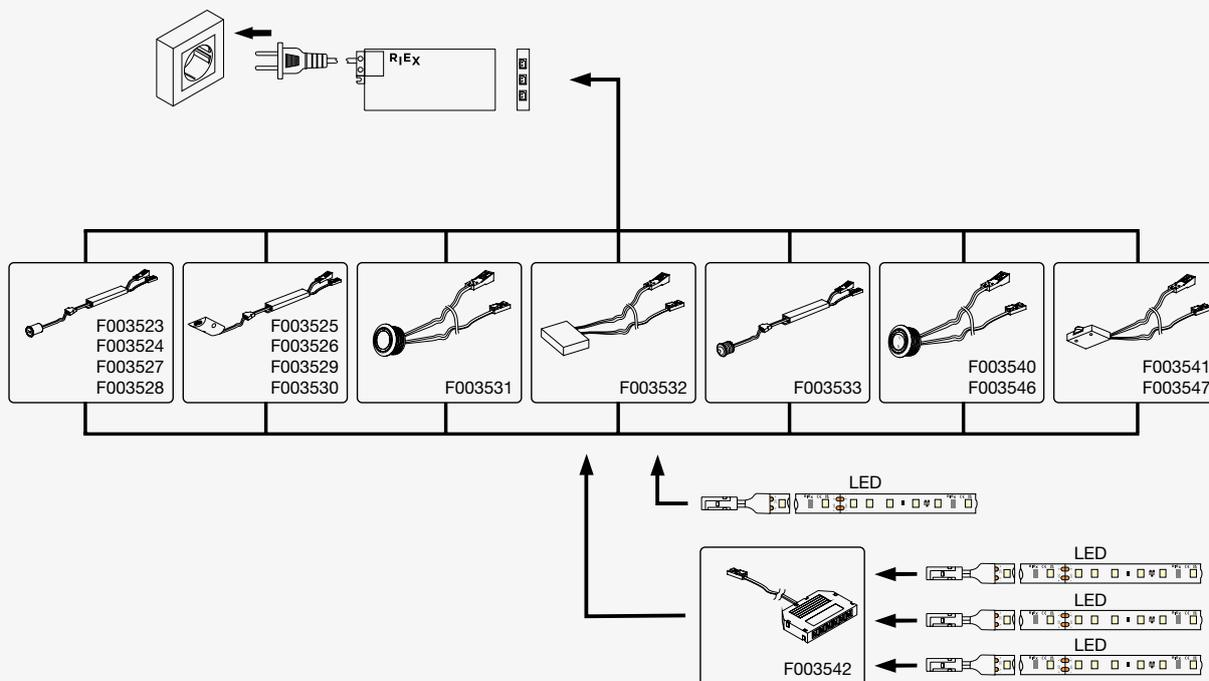



## ⊕ Riex EC35 Senzor za dodir

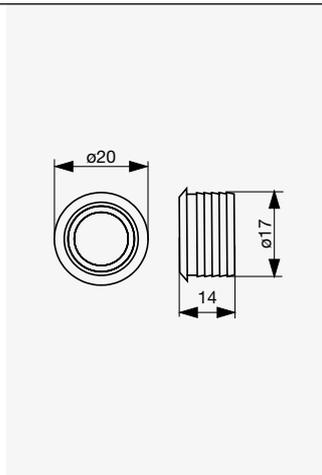

- Senzor na dodir – uključite / isključite svjetlo dodirom na senzor
- Funkcija zatamnjenja dugim dodirom
- Plava dioda za pronalaženje položaja u mraku
- Montaža u interijeru
- Napon 12 / 24V DC
- Maksimalna snaga 60 W
- Kabeli 1,5 ms MINI konektori za brzu instalaciju

Boje senzora

Kod

Srebrna

F003531

## ⊕ Riex EC36 Skriveni senzor

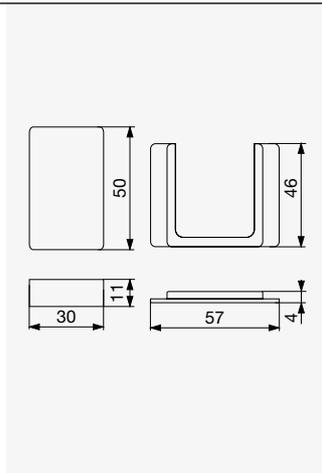

- Skriveni senzor – uključivanje / isključivanje svjetla dodirom kroz ploču [maks. 19 mm\*]
- Funkcija zatamnjenja dugim dodirom
- Napon 12 / 24V DC
- Maksimalna snaga 60 W
- Kabeli 0,1 ms MINI konektori za brzu instalaciju

Tip

Kod

Skriveni senzor

F003532

\* Debljina od 19 mm odnosi se na drvo, melamin i ivericu, ne prolazi kroz materijale s metalnim premazom.

## ⊕ Riex EC37 PIR senzor

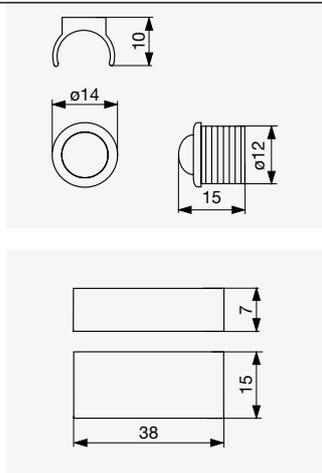

- PIR senzor – paljenje / gašenje svjetla kada se detektira pokret
- Udaljenost osjetljivosti 1–3 m, ovisno o smjeru i intenzitetu kretanja
- Napon 12 / 24V DC
- Maksimalna snaga 60 W
- Kabeli 1 ms MINI konektori za brzu instalaciju

Boje senzora

Kod

Crna

F003533

## ⊕ Riex EC31 Senzor za vrata



● Crno



○ Bijelo

- Otvaranje vrata
- Montaža unutra / vanjska montaža
- Maksimalni razmak cca 6 cm [ovisno o površini vrata]
- Napon 12 / 24V DC
- Maksimalna snaga 60 W
- Kabeli 1 ms MINI konektori za brzu instalaciju

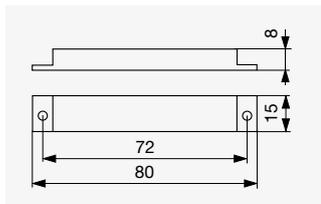
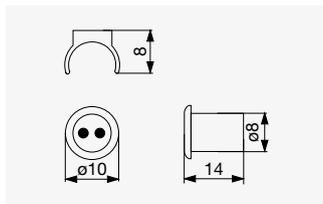

Boje senzora	Kod
Crna	F003523
Bijela	F003524

## ⊕ Riex EC32 Senzor za vrata



● Crno



○ Bijelo

- Vrata otvore
- Vanjska instalacija
- Maksimalni razmak cca 6 cm [ovisno o površini vrata]
- Napon 12 / 24V DC
- Maksimalna snaga 60 W
- Kabeli 1 ms MINI konektori za brzu instalaciju

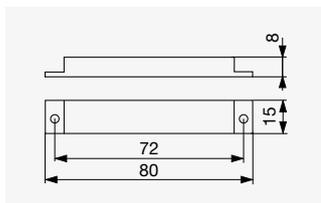
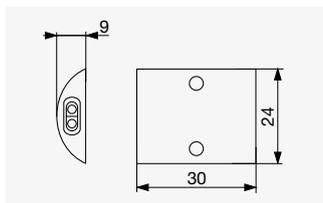

Boje senzora	Kod
Crna	F003525
Bijela	F003526

## ⊕ Riex EC45 Mehanički prekidač vrata



● Crno



○ Bijelo

- Vrata otvore
- Napon 12 / 24V DC
- Maksimalna snaga 60 W
- Kabeli od 1,8 ms, MINI konektori za brzu instalaciju

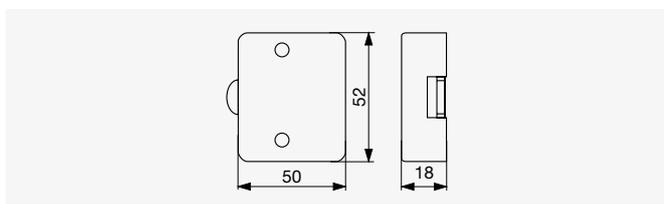

Boja prekidača	Kod
Crna	F003541
Bijela	F003547

## ⊕ Riex EC33 Beskontaktni senzor



● Crno



○ Bijelo

- Senzor bez dodira – uključite / isključite svjetlo valom ispred senzora
- Montaža unutra / vanjska montaža
- Maksimalna udaljenost oko 6 cm
- Napon 12 / 24V DC
- Maksimalna snaga 60 W
- Kabeli 1 ms MINI konektori za brzu instalaciju

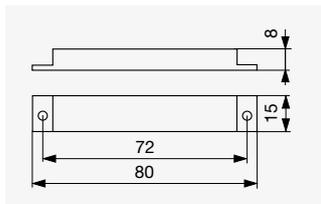
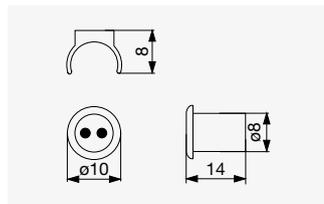

Boje senzora	Kod
Crna	F003527
Bijela	F003528

## ⊕ Riex EC34 Beskontaktni senzor



● Crno



● Srebro

- Senzor bez dodira – uključite / isključite svjetlo valom ispred senzora
- Montaža na površini
- Maksimalna udaljenost oko 6 cm
- Napon 12 / 24V DC
- Maksimalna snaga 60 W
- Kabeli 1 ms MINI konektori za brzu instalaciju

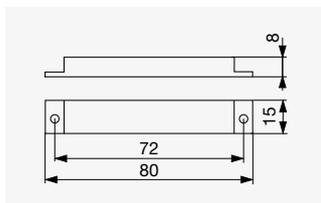
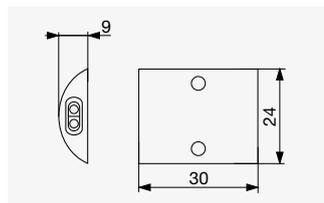

Boje senzora	Kod
Crna	F003529
Srebro	F003530

## ⊕ Riex EC44 Mehanički prekidač



● Crno



○ Bijelo

- Mehanički prekidač
- Napon 12 / 24V DC
- Maksimalna snaga 60 W
- Kabeli od 1,8 ms, MINI konektori za brzu instalaciju

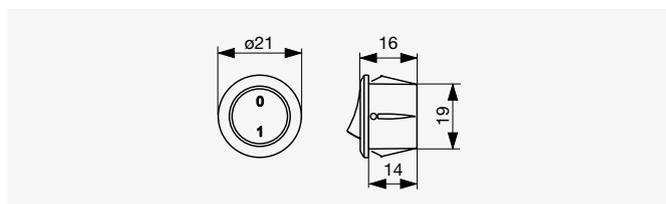

Boje prekidača	Kod
Crna	F003540
Bijela	F003546

### ⊕ Riex EC38 Bežični prekidač na dodir

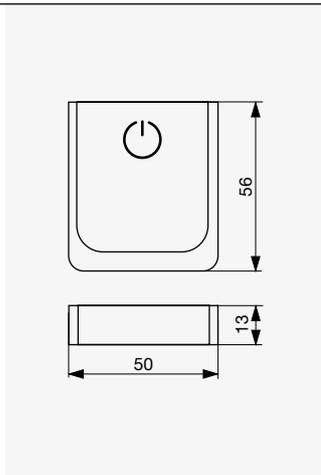

- Bežični prekidač na dodir
- Funkcija zatamnjenja dugim dodirom
- Radna udaljenost od kontrolera do 20 m [bez prepreka]
- Baterija CR2032, standby do 2 godine
- Rad s Riex EC41 i Riex EC42 kontrolerima
- Možete kontrolirati do 99 kontrolera
- Ugradnja instalacija u pod ili na površinu

Boja senzora	Kod
Crna	F003534

### ⊕ Riex EC39 Bežični PIR senzor

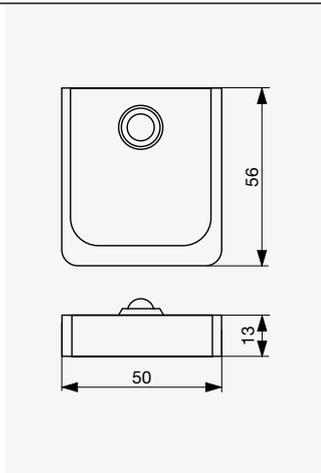

- Bežični PIR senzor
- Udaljenost osjetljivosti 1–3 m, ovisno o smjeru i intenzitetu kretanja
- Radna udaljenost od kontrolera do 20 m [bez prepreka]
- Baterija CR2032, standby do 2 godine
- Rad s Riex EC41 i Riex EC42 kontrolerima
- Možete kontrolirati do 99 kontrolera
- Ugradnja instalacija u pod ili na površinu

Boja senzora	Kod
Crna	F003535

13

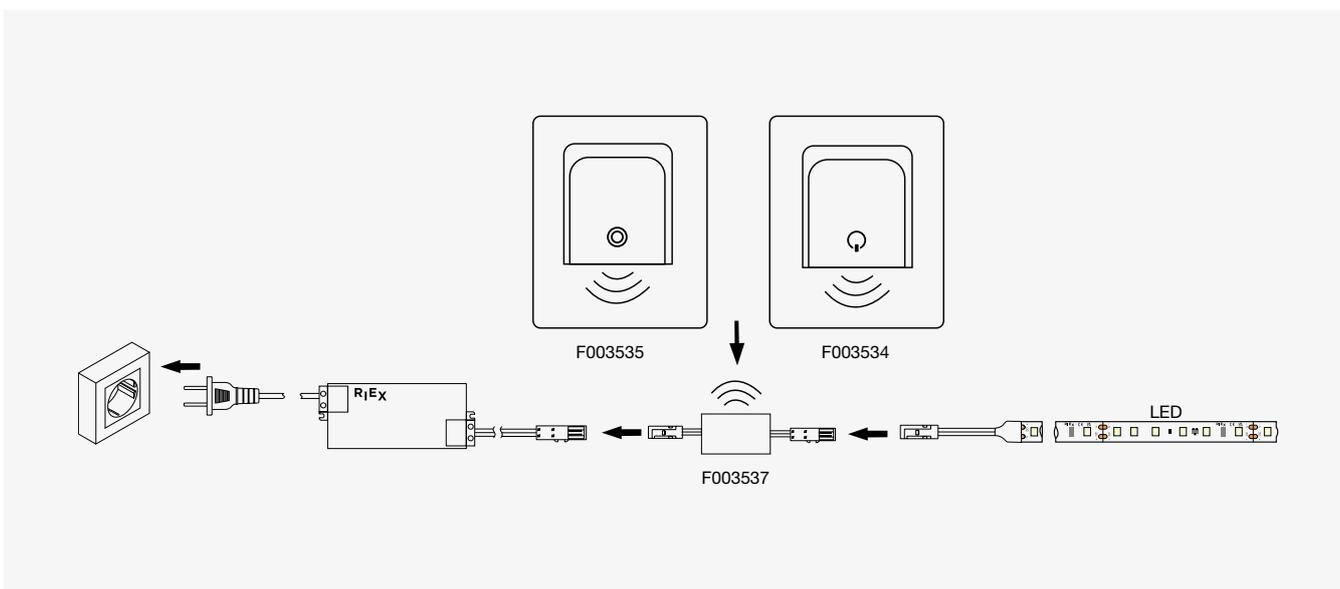

## ⊕ Riex EC41

### Žičani kontroler 1 izlaz

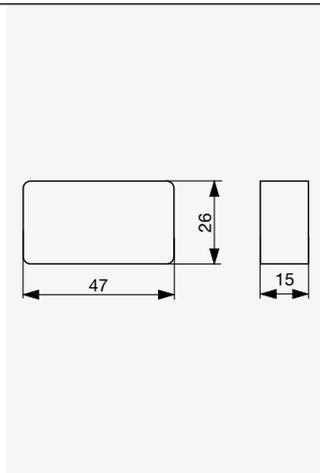

- Bežični upravljač
- Funkcija zatamnjenja dugim dodirrom
- Napon 12 / 24V DC
- Maksimalna snaga 60 W
- Kabeli 0,2 ms MINI konektori za brzu instalaciju
- Jedan kontroler može kontrolirati do 4 senzora.

Tip	Kod
1 izlaz	F003537

## ⊕ Riex EC42

### Žičani upravljač 6 izlaza

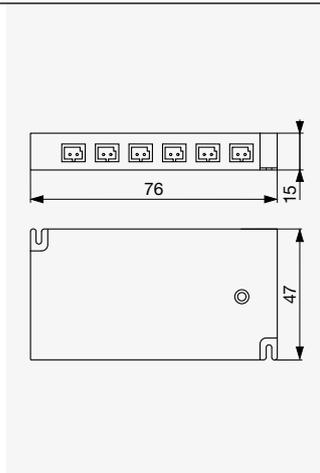

- Žičani upravljač za rad s Riex EC38 i EC39 senzorima
- Funkcija zatamnjenja dugim dodirrom
- Napon 12 / 24V DC
- Maksimalna snaga 90 W
- Ulazni kabel 0,2 ms MINI konektori za brzu instalaciju
- + 6 MINI izlaza za spajanje više svjetala
- Jedan kontroler može kontrolirati do 4 senzora
- Dvostruki ulazni kabel mora biti spojen na isti transformator snage iznad 60W

Tip	Kod
6 izlaza	F003538

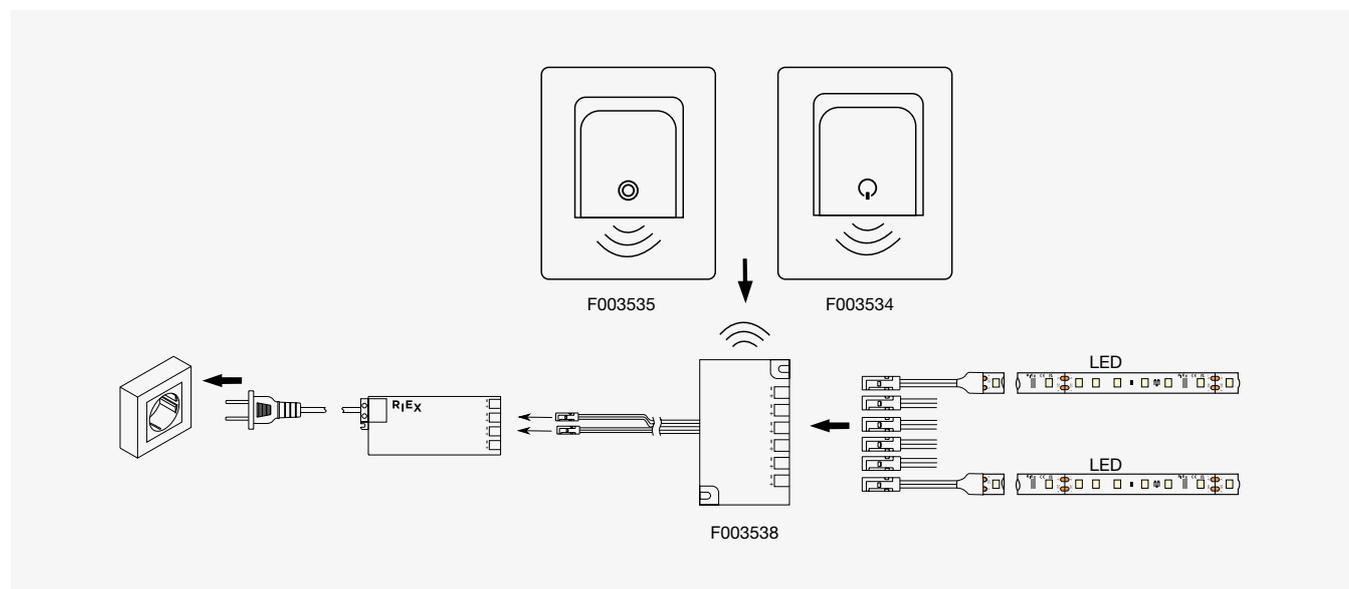

## Ⓞ Riex EC48 Tuya Wifi kontroler



- Wifi kontroler za LED trake i svjetla
- Dizajnirano za RGB LED trake [3-kanalne], također se može koristiti za jednobojne ili dvobojne trake
- Kompatibilan s Tuya otopinom
- Napon 12 / 24V DC
- 3 kanala, maks. 6 A / kanalu, ukupno max. 10 A
- Maksimalna snaga 120 W [12V], 240 W [24V]
- Podržava WiFi 2,4 GHz 802.11 b / g / n
- Potrošnja u stanju mirovanja < 0,3 W
- Ulaz: konektor
- Izlaz: priključni konektor

**Upute:**

- Instalacija aplikacije Tuya Smart [QR ili Store]
- Registrirajte se ili kreirajte račun [ograničena funkcionalnost moguća bez računala]
- Spojite regulator na napajanje, regulator počinje u načinu rada za usklađivanje
- Telefon će automatski tražiti uređaj
- Dodajte uređaj i unesite Wifi lozinku
- Kontrola svjetla pomoću pravog načina rada [jedna boja / RGB itd.]

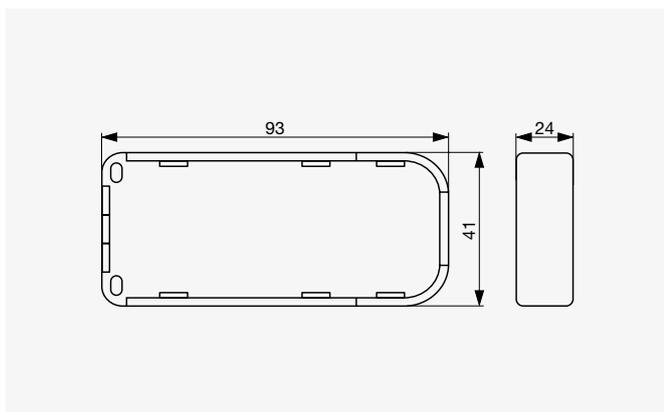

Tip	Kod
Wifi kontroler	F004718



13

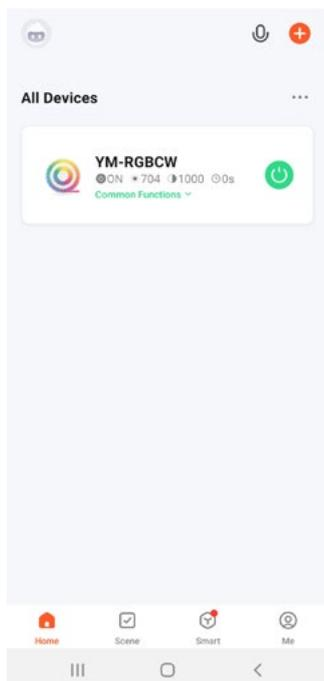

Ⓞ Povezani uređaj



Ⓞ RGB kontrola

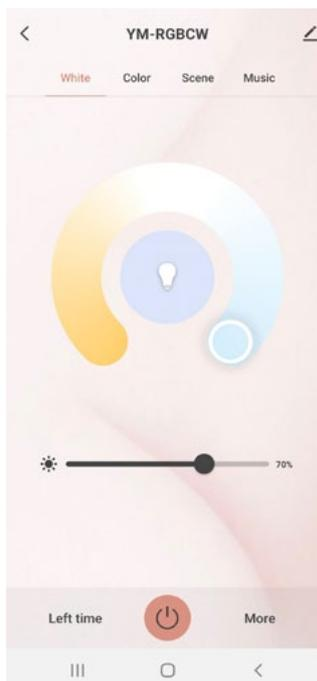

Ⓞ Bijela kontrola

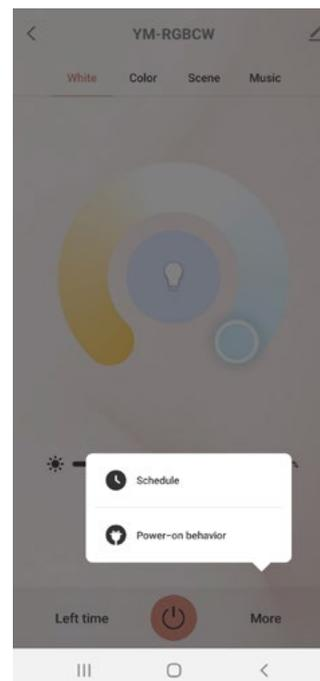

Ⓞ Ostale opcije

## ⊕ Riex EC91 Razdjelnik

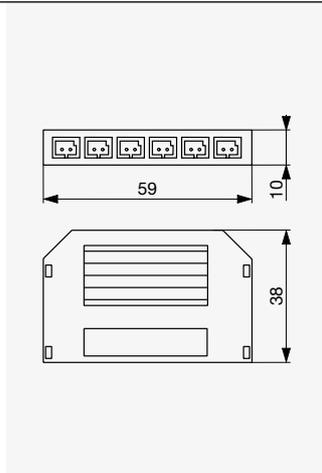

- Razdjelnik 12 / 24V
- 6 izlaza s MINI konektorima za brzu instalaciju
- Napon 12 / 24V DC
- Maksimalna snaga 60 W, pojedinačni izlaz max. 30 W
- Kabeli 1,8 ms na MINI konektore

Tip

Kod

6 izlaza

F003542

## ⊕ Riex EC94 Razvodni kabel sa 2 izlaza



- Dijeljenje izlaza iz upravljačkog programa ili senzora
- Duljina 0,2 m, MINI konektori 1x muški + 2x ženski
- Maksimalno opterećenje 60 W

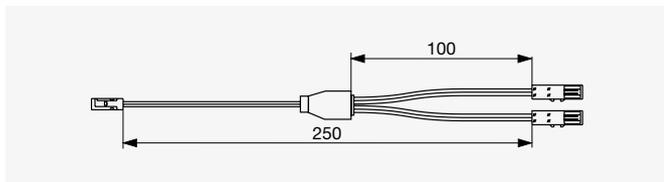

Tip

Kod

2 izlaza

F003545

## ⊕ Riex EC92 Produžni kabel



- Produžni kabel s MINI 12 / 24V konektorom
- Duljina 1,8 m, konektori MINI muški + ženski
- Maksimalno opterećenje 60 W

Duljina  
[m]

Kod

1,8

F003543

### ⊕ Riex EC93

#### Kabel za lemljenje



- Za spajanje izlaza iz drivera ili senzora s LED trakama 12/24 V
- Duljina 1,8 m, MINI muški konektor + slobodni krajevi
- Maksimalno opterećenje 60 W

Duljina [m]	Kod
1,8	F003544

### ⊕ Riex EC20

#### Kabel 2 × 0,5 mm<sup>2</sup>



- Preporuča se za ugradnju duljeg voda veće snage
- Kompatibilan s kabelskim priključcima
- Crno / crvena žica, 20 AWG, maks. 300 V

Duljina [m]	Kod
25 m	F004860



## ⊕ Riex EC10

### Kabelska brza veza



- Za spajanje dva kabijela 0,34–0,78 mm<sup>2</sup>, 22–18 AWG
- Brzo spajanje – umetnite kablove i stegnite ih kliještima, nemojte skidati žice!
- Napon 12 / 24 / 230 V
- Strujni protok max. 9 A, snaga 108 W [12 V] / 216 W [24 V], 500 W [230 V]
- IP20 za unutarnju upotrebu

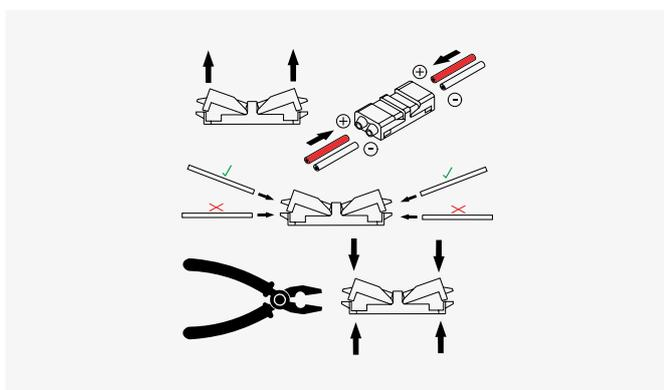

Tip

Kod

Kabelski konektor

F004856

## ⊕ Riex EC11

### Brza spojnica grane



- Za formiranje grane, za kabel 0,34–0,78 mm<sup>2</sup>, 22–18 AWG
- Brzo spajanje – umetnite kablove i stegnite ih kliještima, nemojte skidati žice!
- Napon 12 / 24 / 230 V
- Strujni protok max. 9 A, snaga 108 W [12 V] / 216 W [24 V], 500 W [230 V]
- IP20 za unutarnju upotrebu

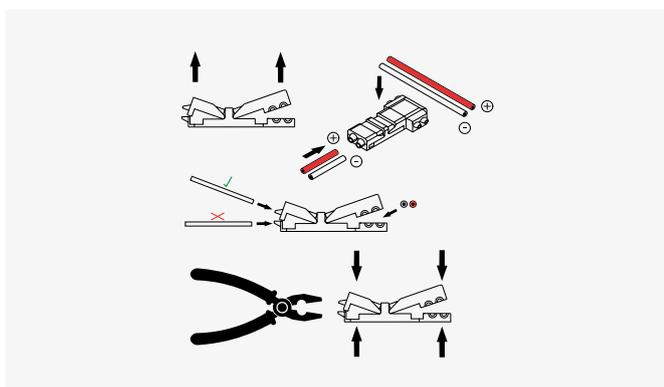

Tip

Kod

Konektor u obliku slova T

F004857

## ⊕ Riex EC01

### Brzo spajanje 2x LED trake

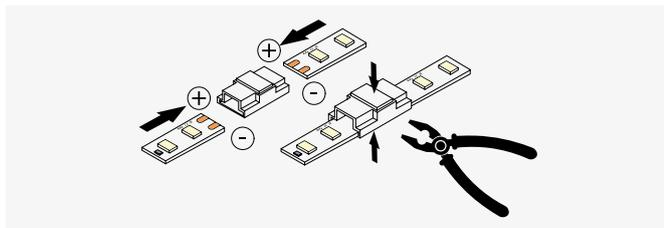
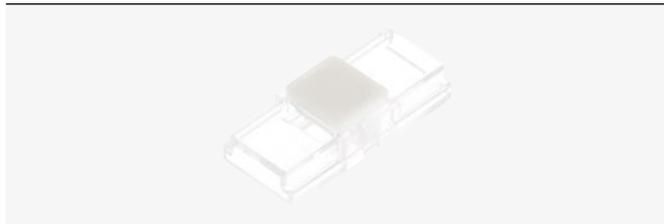

- Za spajanje dvije LED trake
- Brzi spoj – umetnite LED trake i pritisnite ih kliještima
- Dizajniran za IP20 LED trake, ostale vrste moraju se ukloniti
- Provjerite polaritet prije pritiskanja – ne može se ukloniti
- Ugodan dizajn – pogodan za aluminijske profile\*
- Napon 12 / 24 V
- Strujni protok max. 5 A, snaga 60 W [12V] / 120 W [24V]
- IP20 za unutarnju upotrebu

Širina LED trake [mm]	Kod
8	F004851
10	F004852

\* Minimalna unutarnja širina LED profila je 10 mm za LED trake od 8 mm i 12 mm za LED trake od 10 mm, minimalna unutarnja visina je 4,3 mm.

## ⊕ Riex EC02

### Brzo spajanje žice x LED traka

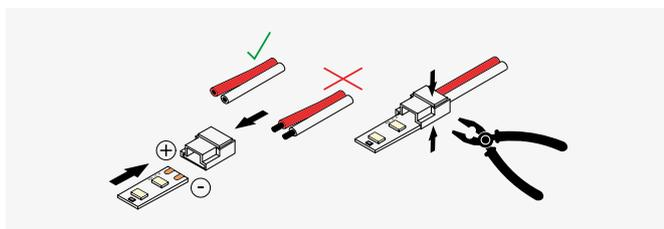
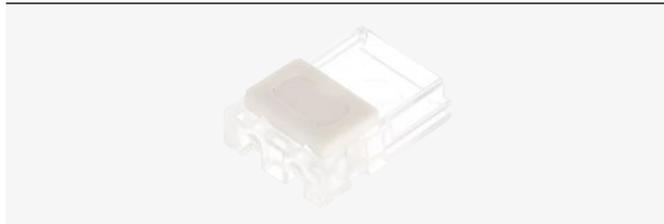

- Za spajanje LED trake sa žicama
- Brzi spoj – umetnite LED traku i žicu i pritisnite kliještima
- Prikladne žice 0,5 mm<sup>2</sup>, 20 AWG, ne uklanjajte žice!
- Dizajniran za IP20 LED trake, ostale vrste moraju se ukloniti
- Provjerite polaritet prije pritiskanja – ne može se ukloniti\*
- Ugodan dizajn – pogodan za aluminijske profile\*
- Napon 12 / 24 V
- Strujni protok max. 5 A, snaga 60 W [12V] / 120 W [24V]
- IP20 za unutarnju upotrebu

Širina LED trake [mm]	Kod
8	F004853
10	F004854

\* Minimalna unutarnja širina LED profila je 10 mm za LED trake od 8 mm i 12 mm za LED trake od 10 mm, minimalna unutarnja visina je 4,3 mm.

## ⊕ Riex EC03

### Brzo spajanje 2x COB LED trake

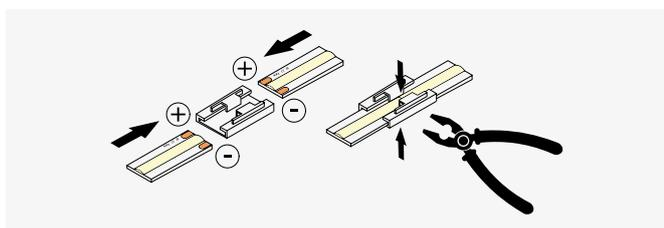

- Za spajanje dvije COB LED trake
- Brzi spoj – umetnite COB LED trake i pritisnite kliještima
- Najmanji razmak i prozirno tijelo za održavanje kontinuirane linije
- Provjerite polaritet prije pritiskanja – ne može se ukloniti
- Ugodan dizajn – pogodan za aluminijske profile\*
- Napon 12 / 24 V
- Strujni protok max. 5 A, snaga 60 W [12V] / 120 W [24V]
- IP20 za unutarnju upotrebu

Širina LED trake [mm]	Kod
10	F004855

\* Minimalna unutarnja širina LED profila je 11,6 mm, visina 3,3 mm.

## ⊕ Riex EC06 Kutna spojnica

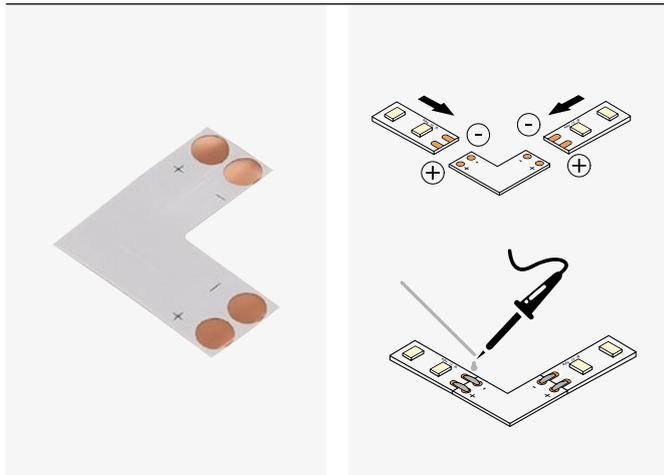

- Za kutni spoj
- Može se lemiti ili s brzim spojnicama EC 01
- Napon 12 / 24 V
- Trenutni maksimum. 3A, snaga 36 W [12V] / 72 W [24V]
- IP20 za unutarnju upotrebu

Širina LED trake [mm]	Kod
8	F004858
10	F004859

## ⊕ Riex EC16 Stezaljka za LED traku



- Stezaljke za spajanje LED traka
- Spriječite ljuštenje, preporučuje se korištenje na početku kako bi se zadržala težina kabijela
- Transparentan
- Vijčani spoj
- Za LED trake IP20 [nije vodootporan]

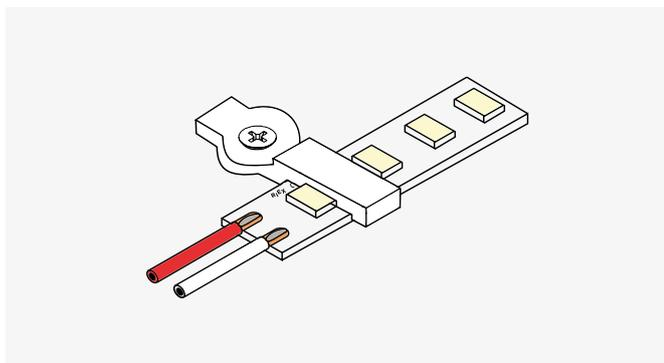

Širina LED trake [mm]	Kod
8	F004861
10	F004862

# Električne utičnice

- Rješenje za elektrifikaciju namještaja
- Spremno za brzu montažu

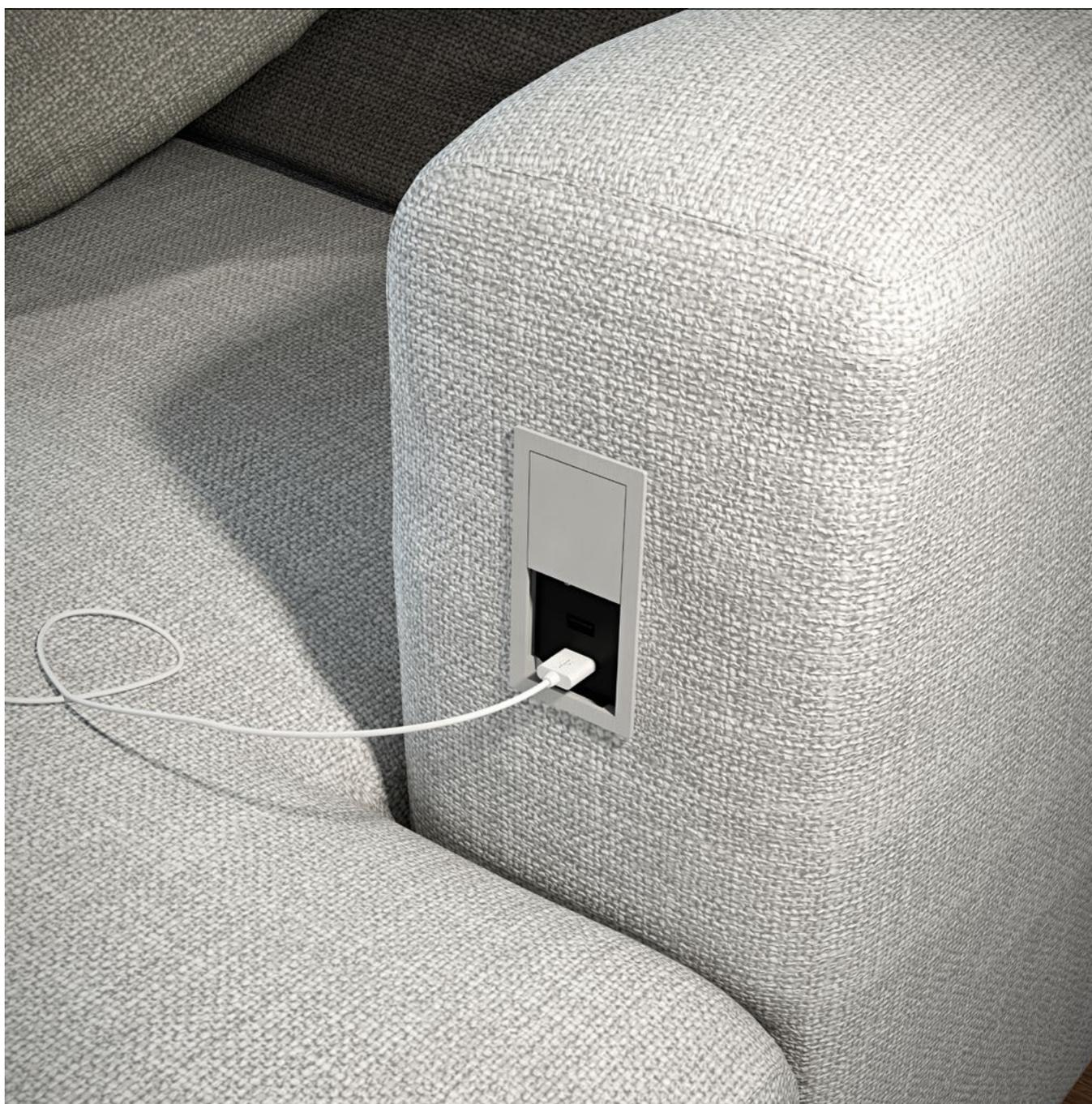

13

# Tip utičnice



Vrsta utičnica	Kod	Skica	Korišteni u zemljama
Francuski	Tip E		B, CZ, F, PL, SK
Schuko	Tip F		AT, BG, BY, DE, EE, ES, FI, GR, HR, HU, IT, LT, LV, MK, NL, NO, RO, RS, SE, SI, UA i većini drugih zemalja EU
UK	Tip G		UK

## ⦿ Riex ED55 Podizna dizalica s USB punjačem

- Ugodan dizajn zahtijeva najmanje prostora
- Aluminijsko kućište dizajnirano za debljinu od 8–45 mm
- Kabel za napajanje 2 m sa utikačem
- Quick Charge 3.0 za verziju s USB izlazom

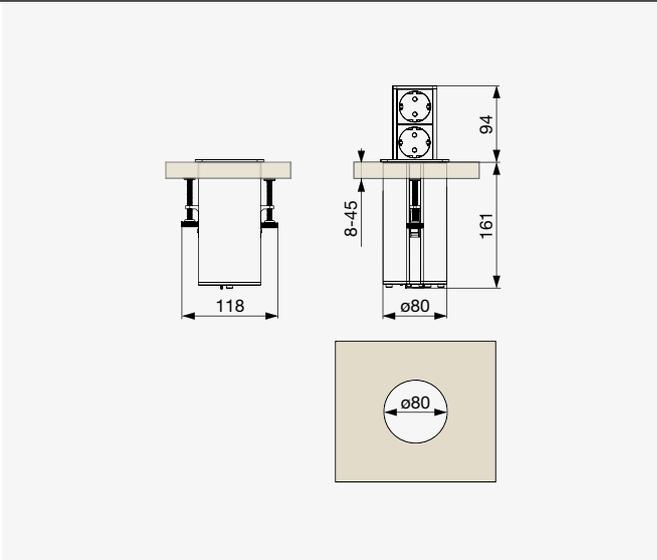

Tip utičnice	Električne utičnice	Druga oprema	Boja	Kod
Schuko tip F	2	×	Crna / Nehrđajući čelik	F003644
	1	1 × USB A + 1 × USB C	Bijela / Nehrđajući čelik	F003646
Francuski tip E	2	×	Crna / Nehrđajući čelik jeklo	F003645
	1	1 × USB A + 1 × USB C	Bijela / nerjaveće jeklo	F003647

## ⊕ Riex ED56

### Okvir stola s utičnicama

- Ugodan dizajn zahtijeva najmanje prostora
- Alumijsko kućište, crna plastika + srebrna anodizacija
- Kabel za napajanje 0,4 m sa GST18 utikačem
- Kabeli s GST konektorom Riex ED61 i ED62 str. 13.52
- Prazna pozicija za prilagodbu s ključnim kamenovima, vidi str. 13.52

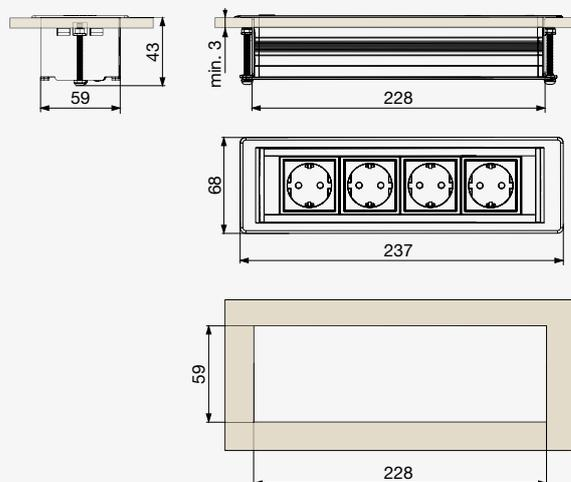

Tip utičnice	Električne utičnice	Ostala oprema	Boja	Kod
Schuko tip F 	4	×	Crna	F003648
	3	1 × prazan modul	Brušeni aluminij	F003642
Francuski tip E 	4	×	Crna	F003649
	3	1 × prazan modul	Brušeni aluminij	F003643

## ⊕ Riex ED57

### Okvir stola s poklopcem

- Ugodan dizajn zahtijeva najmanje prostora
- Alumijsko kućište, crna plastika + srebrna anodizacija
- Kabel za napajanje 0,4 m sa GST18 utikačem
- Kabeli s GST konektorom Riex ED61 i ED62 str. 13.52

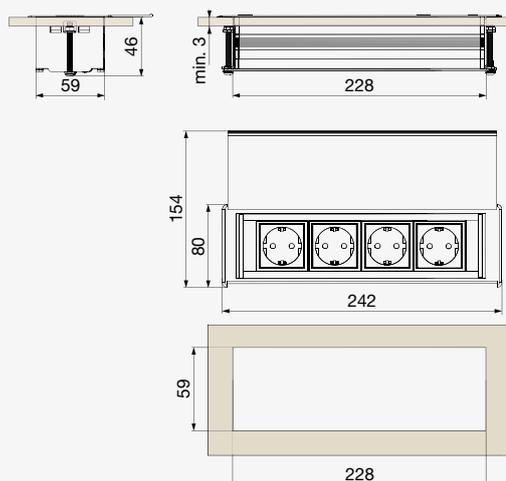

Tip utičnice	Električne utičnice	Kod
Tip Schuko F 	4	F003650
Francuski tip E 	4	F003651

## ⊕ Riex ED61 GST kabel za napajanje



- Za električni priključak
- Priključak GST18

Duljina [mm]	Kod
2000	F003652
3000	F003653

## ⊕ Riex ED62 GST Priključni kabel



- Za spajanje između više utičnica
- Konektor GST18 muški + ženski

Duljina [mm]	Kod
2000	F003654
3000	F003655

## ⊕ Riex ED65 Ključevi i pribor



⊕ F003658



⊕ F003659

- Za ugradnju u prazne module
- Crna boja



⊕ F003660



⊕ F003661



⊕ F003662

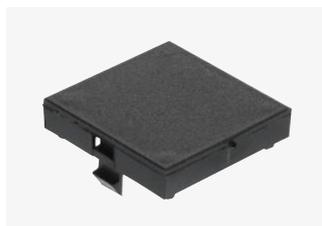

⊕ F003663

Tip	Kod
RJ45 Cat6 [F / F]	F003658
HDMI [F / F]	F003659
Keystone USB 3.0 [A / A]	F003660
Okvir za 1 ključni kamen	F003661
Okvir za 2 ključna kamena	F003662
Poklopac za prazan modul	F003663

## ⊕ Riex ED12

### Električna utičnica sa spojnicom i USB punjačem

- 1× USB A i 1× brzi punjač USB C 18 W
- Crno kućište i moduli
- Kabel za napajanje 2 m sa utikačem



⊕ F004865

Tip utičnice	Električne utičnice	Ostala oprema	Kod
Tip Schuko F 	4		F004866
Francuski tip E 	4	1× USB A + 1× USB C	F004865
UK tip G 	4		F004867

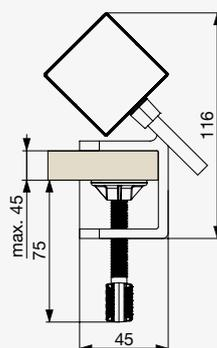
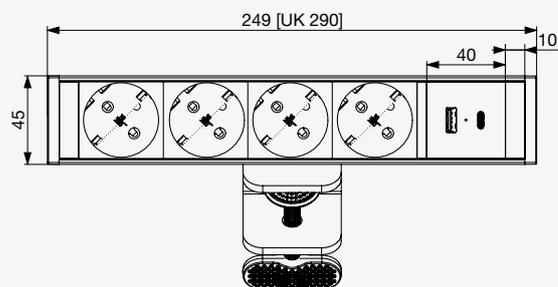

## ⊕ Riex ED14

### Stolna utičnica

- Crno kućište i moduli
- Kabel za napajanje 2 m sa utikačem



⊕ F004870

Tip utičnice	Električne utičnice	Kod
Tip Schuko F 	4	F004869
Francuski tip E 	4	F004868
UK tip G 	4	F004870

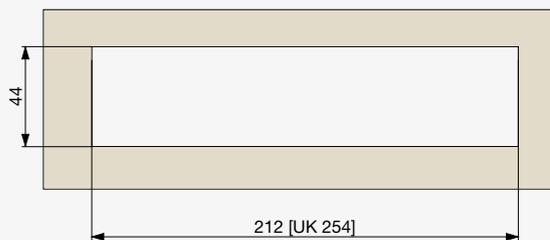
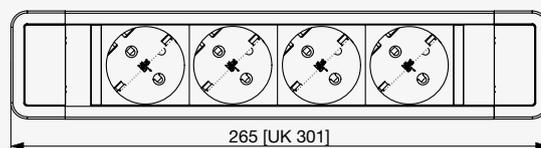
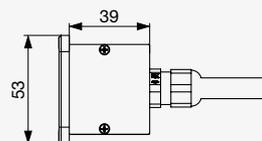



## ⦿ Riex ED15

### Utičnica sa USB punjačem

- 1× USB A i 1× brzi punjač USB C 18 W
- Tijelo od brušenog nehrđajućeg čelika i crni moduli
- Kabel za napajanje 2 m sa utikačem



⦿ F004871

Tip utičnice	Električne utičnice	Ostala oprema	Kod
Francuski tip E 	3		F004871
Tip Schuko F 	3	1× USB A + 1× USB C	F004872
UK tip G 	3		F004873

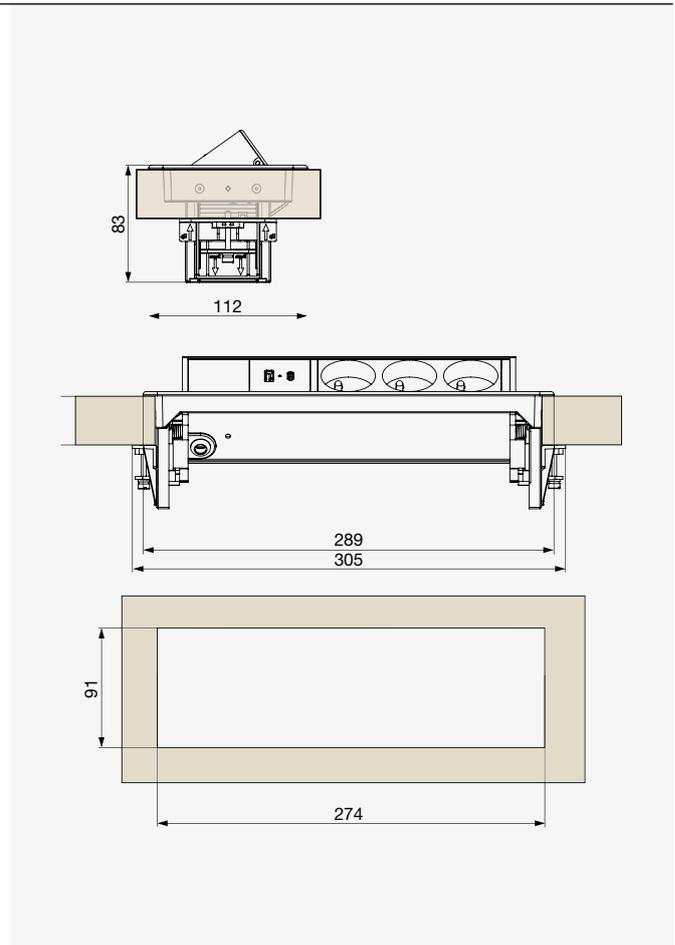

## ● Bachmann Uvijač

- Električna utičnica s rotirajućim poklopcem
- Kabel za napajanje 2 mz sa utikačem



① F004919



① F004920



① F004922

Tip utičnice	Električne utičnice	Boja	Kod
Tip Schuko F 	2	Imitacija nehrđajućeg čelika	F004919
		Mat crna boja	F004921
		Mat bijela	F004923
Francuski tip E 	2	Imitacija nehrđajućeg čelika	F004918
		Mat crna boja	F004920
		Mat bijela	F004922

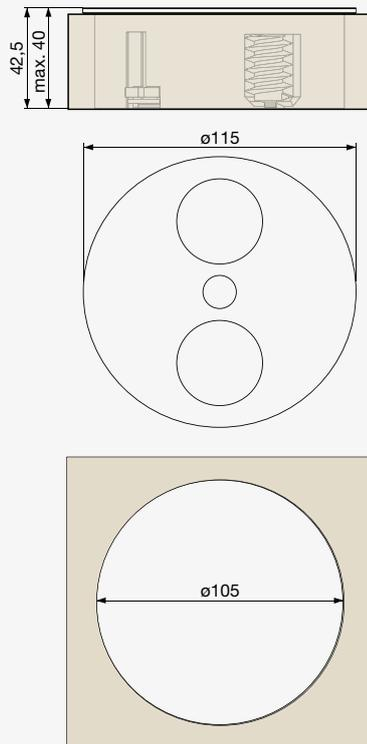

## ● Bachmannova slika

- Jedna električna utičnica modernog dizajna
- Mali montažni promjer od 56 mm
- Prilagodite ga izmjenjivim prstenom u bijeloj i crnoj boji
- Kabel za napajanje 0,2 mz s utikačem GST18 [UK kabel za napajanje 2 mz s utikačem]
- Kabeli s GST konektorom Riex ED61 i ED62 str. 13.52



① F004919



① F004927

Tip utičnice	Električne utičnice	Kod
Tip Schuko F 	1	F004924
Francuski tip E 	1	F004925
UK tip G 	1	F004926
	1 × prazno mjesto*	F004927

\* Prazan položaj za prilagodbu s trapezoidnim kamenjem, pogledajte str. 13.56

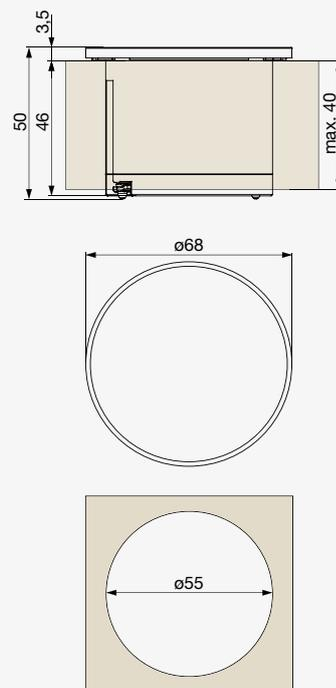

## ● Bachmann Pix dodaci

Okretni poklopac s odgovarajućim ukrasnim prstenom, uključujući poklopce za sve zemlje i verzije konektora.

- Set korica

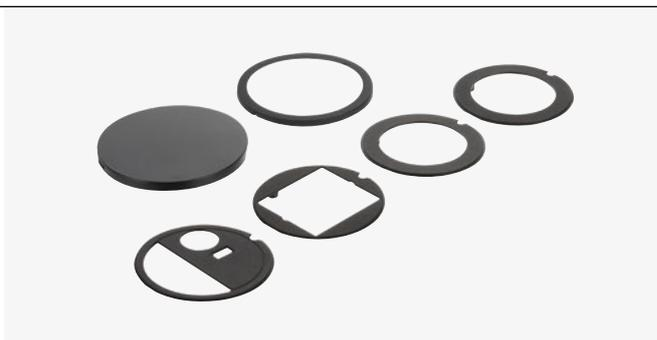

● Mat crna



○ Mat bijela

Boja	Kod
Mat crna	F004928
Mat bijela	F004929

## ● Bachmann Keystones i dodaci

Za prilagodbu Bachmann Pixa s praznim položajem.



① F004930



① F004931



① F004932



① F004933



① F004934



① F004935

Tip	Kod
Okvir za 1 Keystone	F004930
Okvir za 2 ključna kamena	F004931
Poklopac za prazan modul	F004932
Keystone RJ45 CAT6A	F004933
HDMI klasa [F / F]	F004934
Keystone USB 3.0 [A / A] izravni prolaz	F004935

01  
02  
03  
04  
05  
06  
07  
08  
09  
10  
11  
12  
13  
14  
15  
16  
17  
18

## ● SFL Cizo

- Pop-up utičnica
- Ugodan dizajn zahtijeva najmanje prostora
- Metalno kućište dizajnirano za debljinu od 15–45 mm
- Kabel za napajanje 2 m sa utikačem



○ Mat bijela boja



● Mat crna

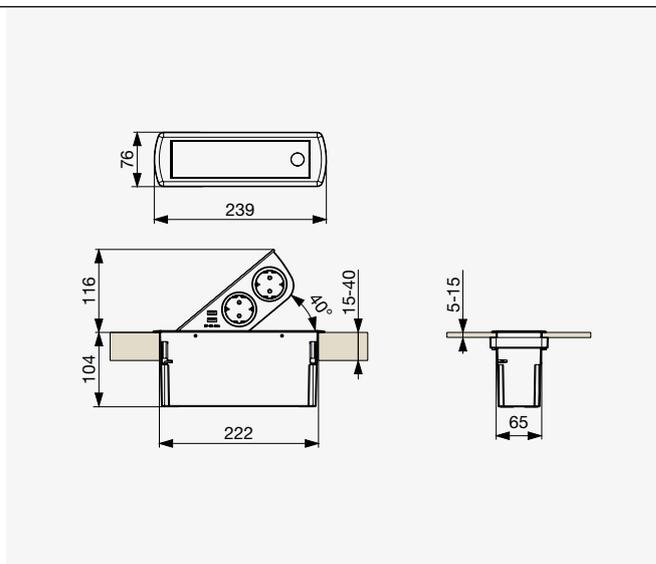

Tip utičnice	Električne utičnice	Ostala oprema	Boja	Kod
Tip Schuko F 	2	2× USB A	Matt black	F003416
			Matt white	F003418
Francuski tip E 	2	2× USB A	Matt black	F003415
			Matt white	F003417

## ● SFL osam

- Utičnica s inovativnim rotirajućim poklopcem Pritisnite za otvaranje
- Metalno kućište dizajnirano za debljinu od 15–40 mm
- Kabel za napajanje 1 m sa utikačem

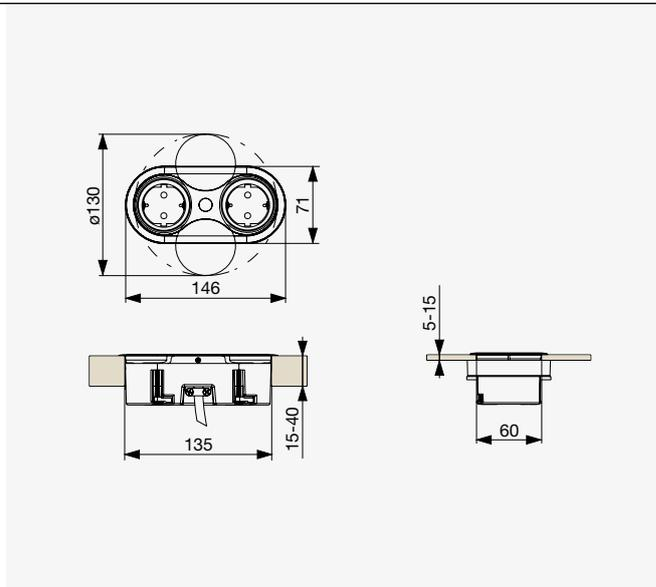

Tip utičnice	Električne utičnice	Boja	Kod
Tip Schuko F 	2	Mat crna boja	F003420
		Nehrdajući čelik	F003422
Francuski tip E 	2	Mat crna boja	F003419
		Nehrdajući čelik	F003421

## ● SFL Born

- Nadzemna utičnica s USB punjačem
- 2x USB A, izlaz 5 V, 2 A
- Metalno kućište
- Kabel za napajanje 2 m sa utikačem



● Nehrđajući čelik



● Mat crna

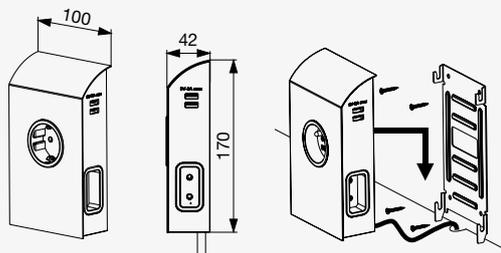

Tip utičnice	Električne utičnice	Ostala oprema	Boja	Kod
Schuko tip F 	1 + 2*	2x USB A	Mat crna boja	F003426
			Nehrđajući čelik	F003425
Francuski tip E 	1 + 2*	2x USB A	Mat crna boja	F003424
			Nehrđajući čelik	F003423

\* 1x standardna strujna utičnica + 2x EU tip C utičnice za ravni utikač s obje strane.

## ● SFL prsten

- Jedna električna utičnica s poklopcem i USB punjačem
- 2x USB A, izlaz 5 V, 1 A
- Ugodan dizajn za otvor od 70 mm
- Metalno kućište dizajnirano za debljinu od 4–45 mm

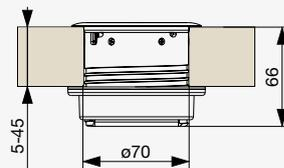

Tip utičnice	Električne utičnice	Ostala oprema	Boja	Kod
Tip Schuko F 	1	1x USB A	Mat crna boja	F003432
			Mat bijela	F003433
Francuski tip E 	1	1x USB A	Mat crna boja	F003430
			Mat bijela	F003431

## ● SFL opeka

- Pop-up usponska utičnica s USB punjačem
- 2x USB A, izlaz 5 V, 2 A
- Ugodan dizajn za otvor od 80 mm
- Aluminijско kućište dizajnirano za debljinu od 4–50 mm
- Kabel za napajanje 2 m sa utikačem

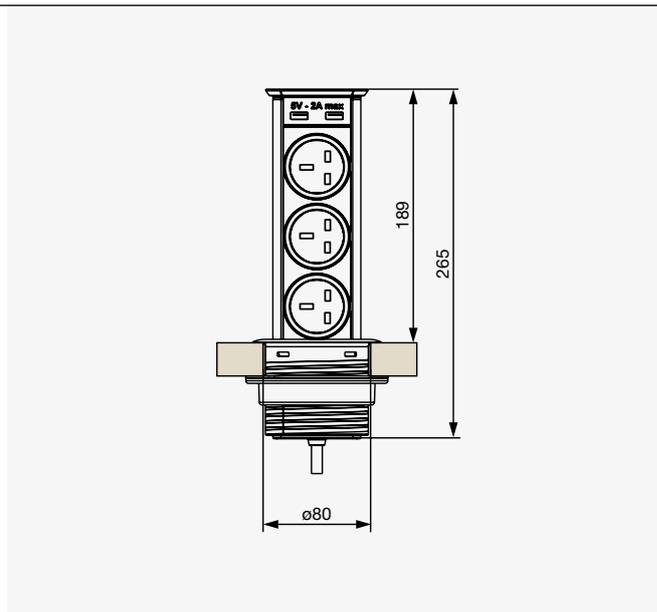

Tip utičnice	Električne utičnice	Ostala oprema	Kod
Tip Schuko F 	3	2x USB A	F003428
Francuski tip E 	3	2x USB A	F003427
UK Tip G 	2	2x USB A	F003429



## ● SFL Merkur

- Inovativna električna utičnica u kombinaciji s LED svjetlom
- LED svjetlo 6 W, neutralno bijelo s mogućnošću prigušivanja
- Mat crno kućište
- Kabel od 0,9 m može se po potrebi skratiti
- Montažu mora izvršiti ovlaštena osoba
- Potrebno je TN-S ožičenje [3 žice, s odvojenim uzemljenjem]

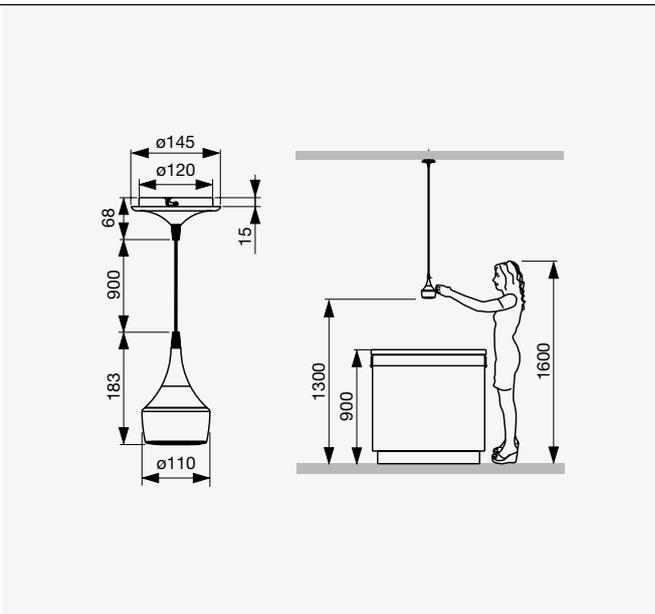

Tip utičnice	Električne utičnice	Kod
Tip Schuko F 	1	F003553
Francuski tip E 	1	F003552
UK Tip G 	1	F003554

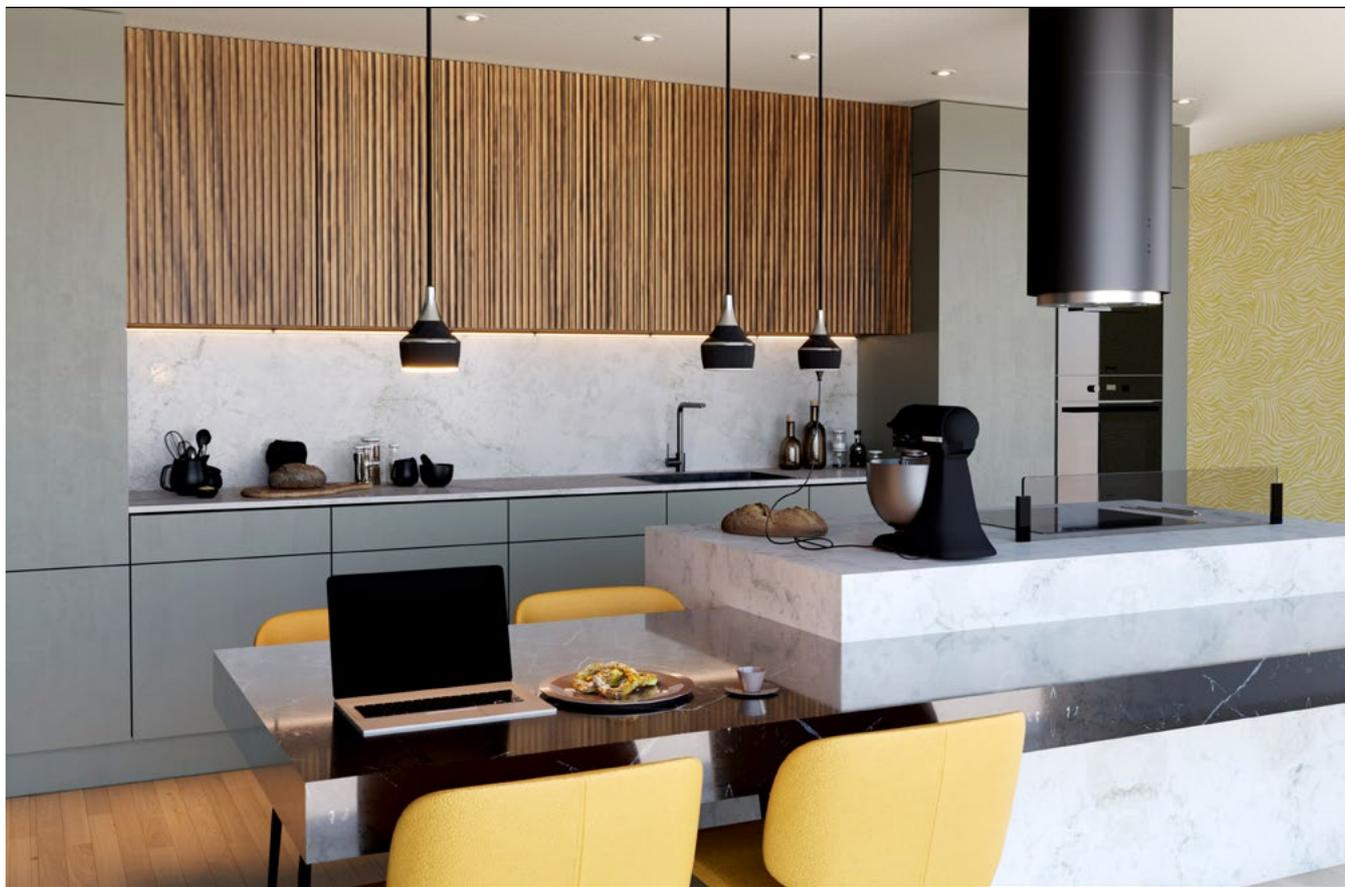

01  
02  
03  
04  
05  
06  
07  
08  
09  
10  
11  
12  
13  
14  
15  
16  
17  
18

## ● ASA Plastici Versahit Mono

- Utičnica s kliznim poklopcem
- IP54 kada je zatvoren
- Kabel za napajanje 2 m s utikačem [utikač nije spojen na kabel radi lakše instalacije]



IP54  
Otpornost



● Nehrđajući čelik



● Mat crna

Tip utičnice	Električne utičnice	Boja	Kod
Tip Schuko F 	1	Nehrđajući čelik	F004895
		Mat crna boja	F004898
Francuski tip E 	1	Nehrđajući čelik	F004894
		Mat crna boja	F004897
UK Tip G 	1	Nehrđajući čelik	F004896
		Mat crna boja	F004899

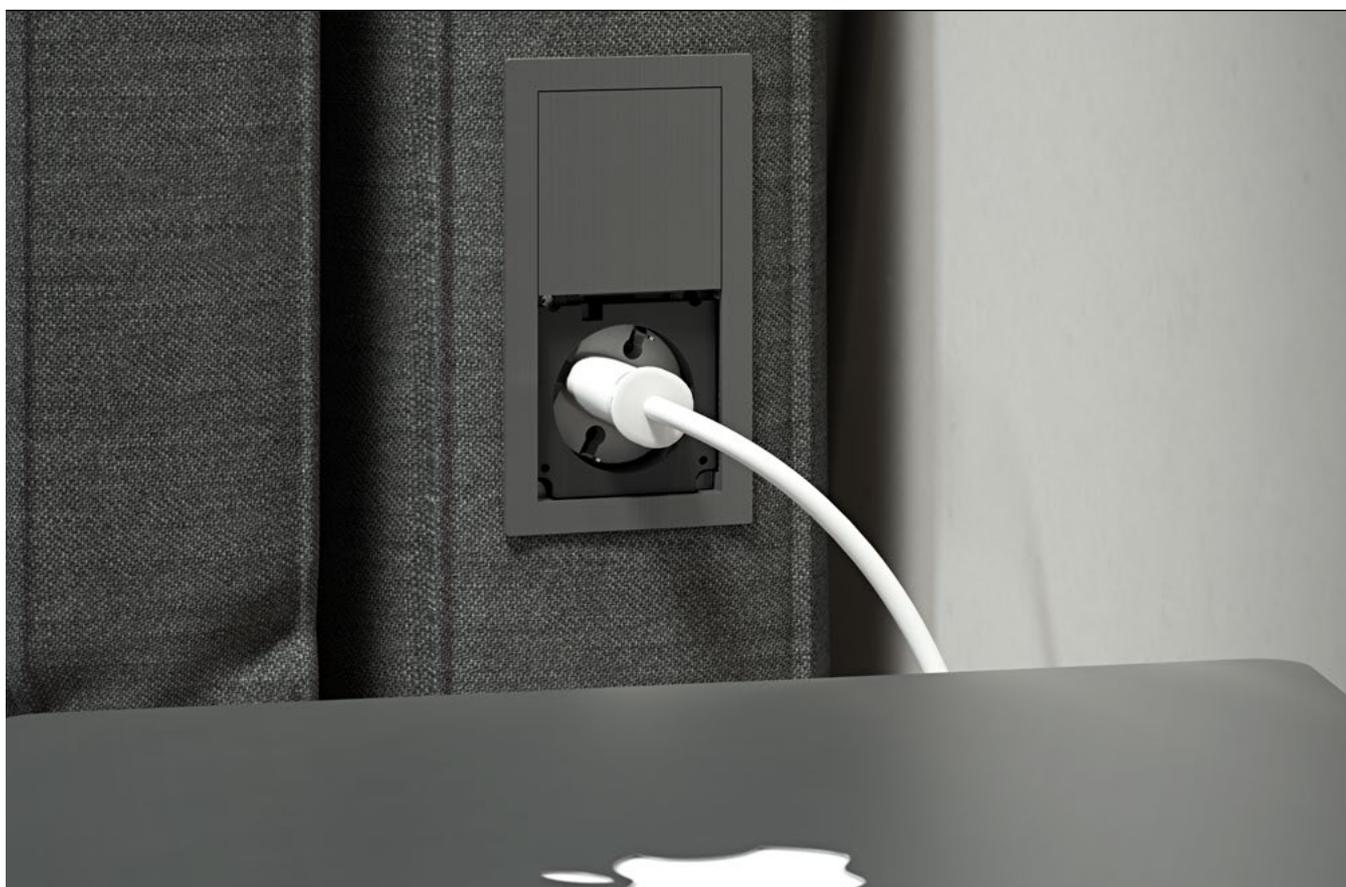
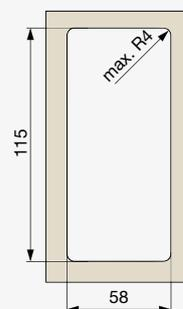
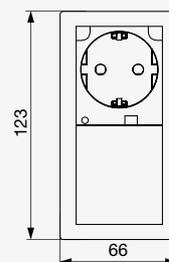
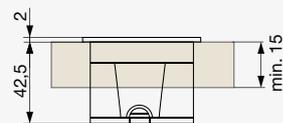



## ● ASA Plastici

### Versahit Mono Combi

- Utičnica s kliznim poklopcem
- Inox – površina od nehrđajućeg čelika
- IP54 kada je zatvoren
- Kabel za napajanje 2 m z s utikačem [utikač nije spojen na kabel radi lakše instalacije]



IP54  
Otpornost



● Nehrdajući čelik

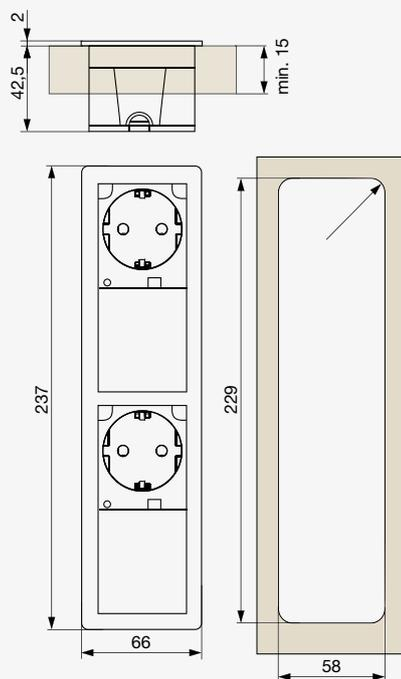

Tip utičnice	Električne utičnice	Druga oprema	Kod
Schuko tip F 	2	×	F004901
	1	2× USB A	F004904
Francuski tip 	2	×	F004900
	1	2× USB A	F004903
UK Tip G 	2	×	F004902
	1	2× USB A	F004905

01  
02  
03  
04  
05  
06  
07  
08  
09  
10  
11  
12  
13  
14  
15  
16  
17  
18

## ● ASA Plastici Versahit Dual

- Utičnica s kliznim poklopcem
- IP54 kada je zatvoren
- Kabel za napajanje 2 m z s utikačem [utikač nije spojen na kabel radi lakše instalacije]



IP54  
Otpornost



● Mat crna

● Nehrđajući čelik

Tip utičnice	Električne utičnice	Boja	Kod
Tip Schuko F 	2	Nehrđajući čelik Mat crna boja	F004433 F004436
Francuski tip E 	2	Nehrđajući čelik Mat crna boja	F004432 F004435
UK Tip G 	2	Nehrđajući čelik Mat crna boja	F004434 F004437

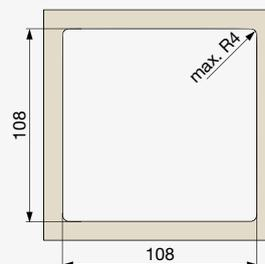
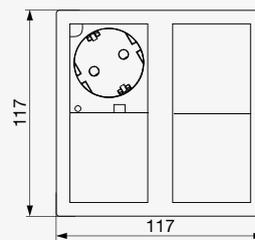

## ● ASA Plastici Versatek Basic

- Međusobno povezivanje električne utičnice
- Mat crna boja
- GST veza
- Kabeli s GST konektorom Riex ED61 i ED62 str. 13.52

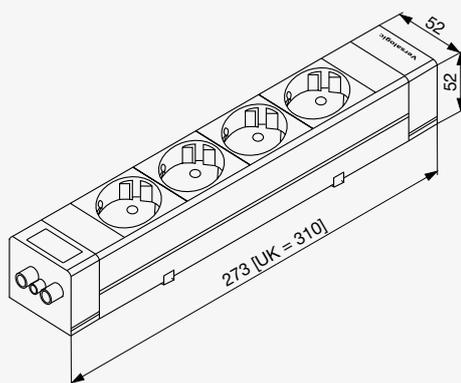

Tip utičnice		Električne utičnice	Kod
Tip Schuko F		4	F004907
Francuski tip E		4	F004906
UK Tip G		4	F004908

## ● ASA Plastici Košara za Versatec

- Veličina 320 x 130 mm
- Materijal – tehnopolimer

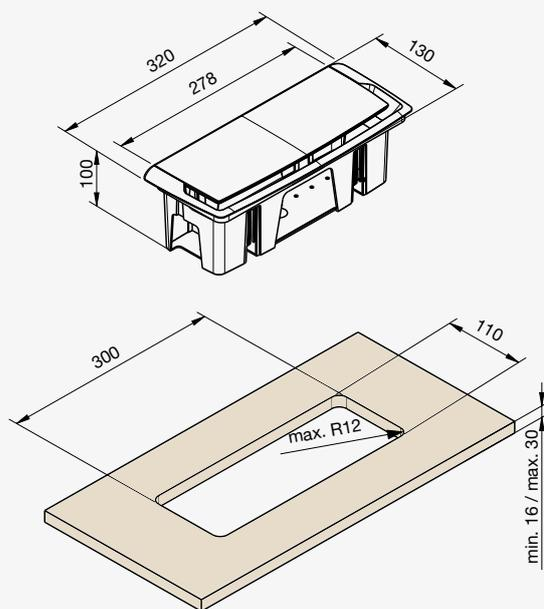

Boja	Kod
Srebro	F004909

## ● ASA Plastici Versapick

- Točka za punjenje
- U kompletu je punjač sa EURO utikačem



## ● ASA Plastici Versapick Plastično tijelo

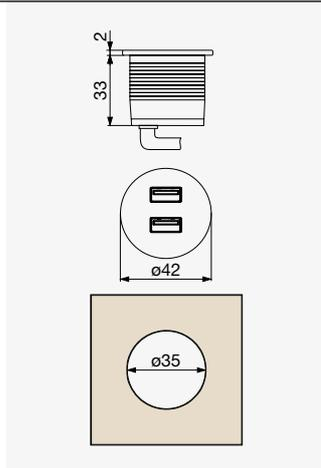

- Izlaz 2x USB A
- Snaga 10 W, 2A

Boja	Kod
Mat bijela	F004910

13

## ● ASA Plastici Versapick Metalno kućište – kvadratnog oblika



- Nehrđajući čelik



- Mat crna

- Mat bijela

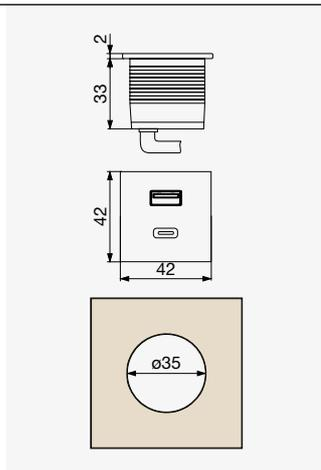

- Otvor  $\varnothing$  35 mm
- Izlaz 1x USB A + 1x USB C
- Brzo punjenje QC 3.0, maksimalna snaga 20 W

Boja	Kod
Nehrđajući čelik	F004911
Mat crna boja	F004912
Mat bijela	F004914

## ● ASA Plastici Versapick Metalno kućište – pravokutni oblik



● Nehrđajući čelik



● Mat crna

○ Mat bijela

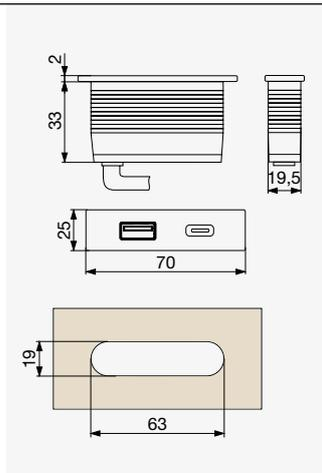

- Otvor 19 x 63 mm
- Izlaz 1x USB A + 1x USB C
- Brzo punjenje QC 3.0, maksimalna snaga 20 W

Boja	Kod
Izrađen od nehrđajućeg čelika	F004915
Mat crna barva	F004916
Mat belo	F004917

## ● ASA Plastici Versapick USB punjač UK utikač



Tip	Kod
USB punjač UK utikač	F004913

Punjač za korištenje Versapicka u zemljama s britanskim utičnicama.

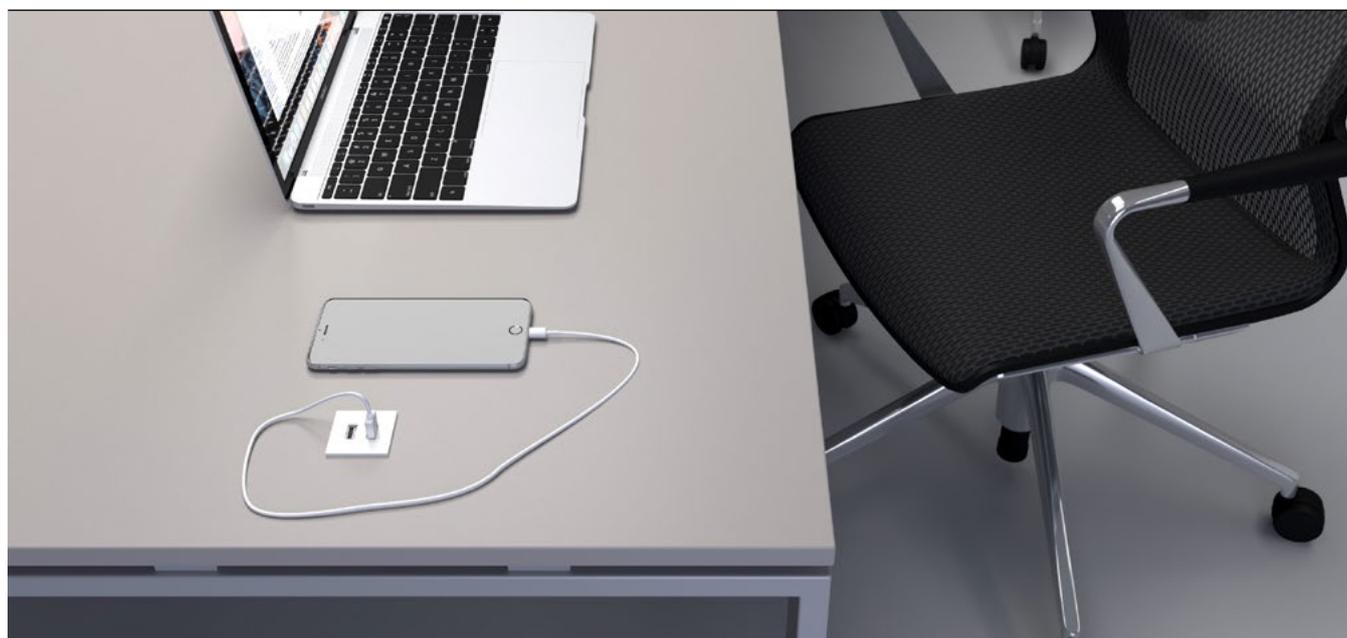

# Sastavljanje okova

Gotovo nijedan namještaj ne bi se mogao sastaviti bez spojnih okova. U ponudi je širok izbor vijaka za drvene materijale, konfirmata, eurovijka, vijaka za spajanje ormara, kao i CAM konektora, tiplova i spojnice za sastavljanje radnih površina. U ponudi imamo i proizvode vodećih europskih proizvođača u ovom segmentu – Fischer za tiple i Spax za vijke. U sljedećem dijelu su vješalice za ormariće s mogućnošću podešavanja položaja ormarića. Ovaj program uključuje marke Riex i Italiana Ferramenta s opcijama za standardne ili visokoučinkovite vješalice. Samoljepljive kape u raznim dekorima i bojama te drugi materijali za popravke nedostataka na drvenim pločama također su dostupni u ovom dijelu.

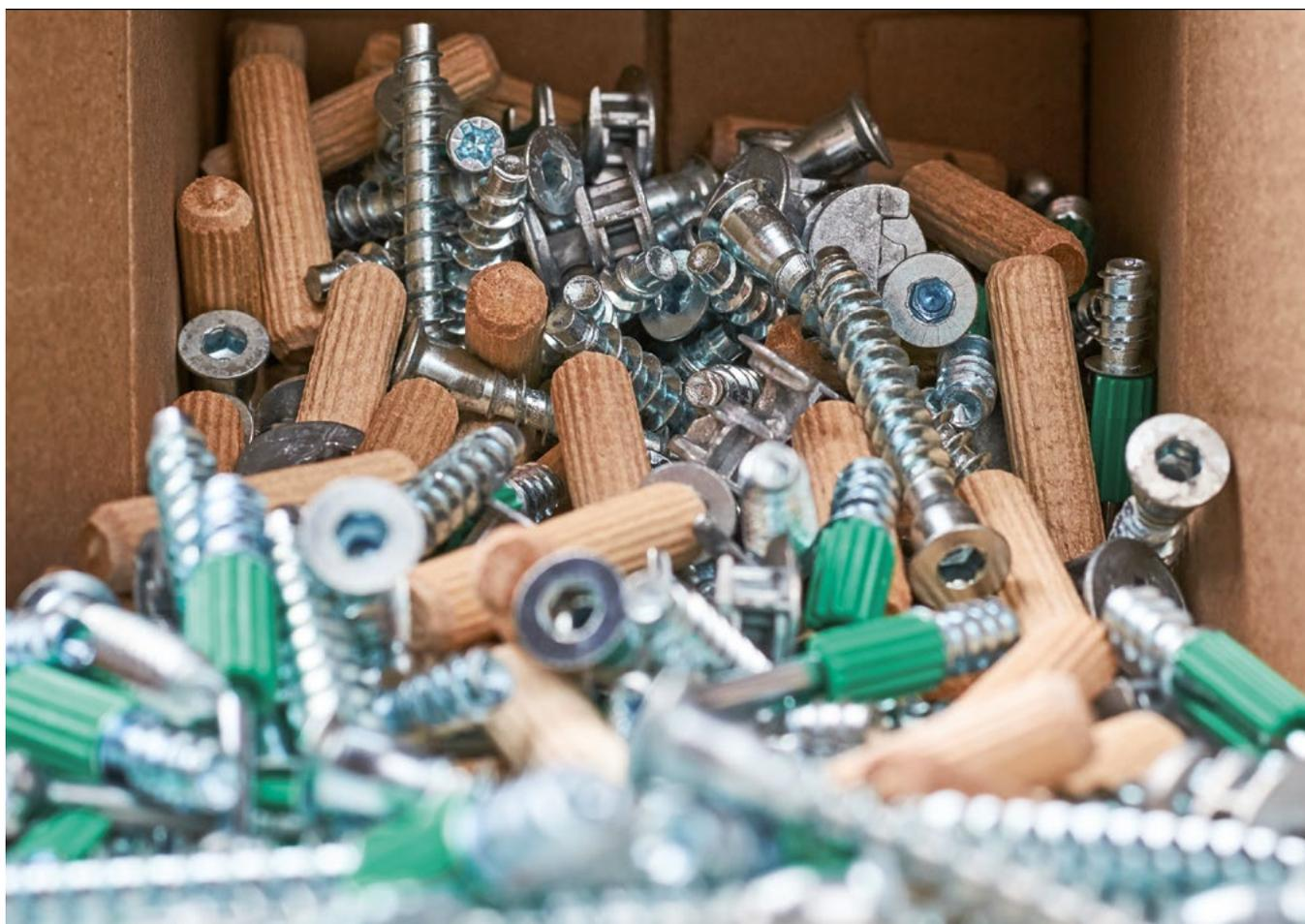

● <b>Vijci</b>	<b>14.3</b>
Spax vijci	14.4
Bitovi vijci	14.9
Riex vijci	14.10
● <b>Fischer nastavci tiple</b>	<b>14.12</b>
● <b>Riex konfirmat vijci i eurovijci</b>	<b>14.18</b>
● <b>Spojni vijci, matice i priključci za radnu površinu</b>	<b>14.20</b>
● <b>Ekscentrične spojnice</b>	<b>14.25</b>
● <b>Drvene tiple</b>	<b>14.28</b>
● <b>Samoljepljive kapice</b>	<b>14.31</b>
● <b>Vješalice za ormare</b>	<b>14.34</b>
Vješalice za ormare	14.34
Riex IF Vješalice za ormare	14.37
● <b>Nosači za police</b>	<b>14.46</b>
● <b>Nosači za police</b>	<b>14.55</b>
● <b>Kutni i priključni nosači</b>	<b>14.60</b>

# Vijci

---

- SPAX vijci – njemački kvalitet i širok izbor modela
  - RLEX vijci – sve osnovne izvedbe vijaka
- 

14





# SPAX

## Glavna razlika od ostalih vijaka



T-STAR plus

- Pozitivno i sigurno prijanjanje BIT sustava i bolju vožnju, npr. pri radu iznad glave



MULTI Head

- Duboko uranjanje. Reže kroz drvo i zaustavlja se na metalu
- Za pričvršćivanje ploča na nosače kada je potrebno produbljivanje glave



4CUT point

- Bez prethodnog bušenja [ovisno o drvu], njegov vrh učinkovito smanjuje cijepanje. Četvrtasti vrh gura zrna drva u stranu i smanjuje moment pri uvrtnju.



Wirox brušeni nazubljeni zarez

- Od duljine vijaka od 160 mm nadalje, poseban dizajn na kraju djelomičnog navoja značajno smanjuje okretni moment pri uvrtnju



Wirox

- Visoka zaštita od korozije
- Velika debljina sloja cinka
- Norma EN 1670
- Ekološki prihvatljiv – bez kroma VI

## ● Spax vijci Ravna kosina glave – PZ



① Puni navoj



① Pola navoja

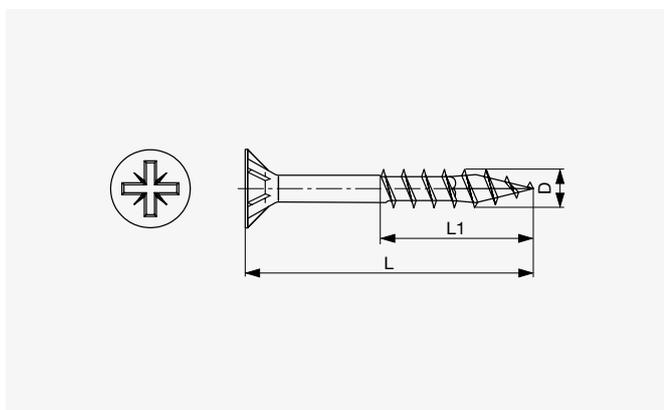
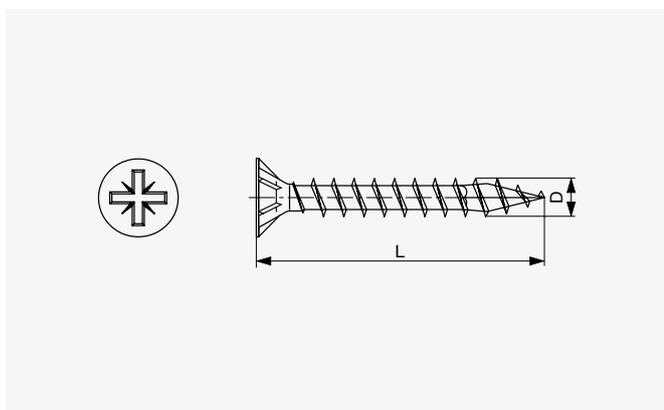

### Cijela nit

Promjer D [mm]	Duljina L [mm]	Kod	Boja
3,0	16	F004240	Bijeli cink
	20	F004241	
3,5	16	F004242	
	20	F004243	
	25	F004244	
	30	F004245	
	40	F004246	
	16	F004247	
4,0	20	F004248	
	25	F004249	
	30	F004250	
	35	F004252	
	40	F004253	
	45	F004254	
5,0	50	F004255	
	50	F004256	
	60	F004257	
	70	F004258	
	80	F004259	

### Pola niti

Promjer D [mm]	Duljina L [mm]	Kod	Duljina navoja L1 [mm]	Boja
4,0	30	F004251	18	Bijeli cink

## ● SPAX vijci Podignuta kosina glave – PZ

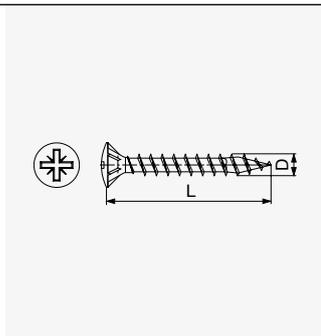

Promjer D [mm]	Duljina L [mm]	Kod	Boja
3,5	16	F004278	Poniklano
	20	F004279	
4,0	16	F004280	
	20	F004281	

## ● Spax vijci

### Ravna kosa glava – TX



● Bijeli cink Puni navoj



● Bijeli cink Polunavoj

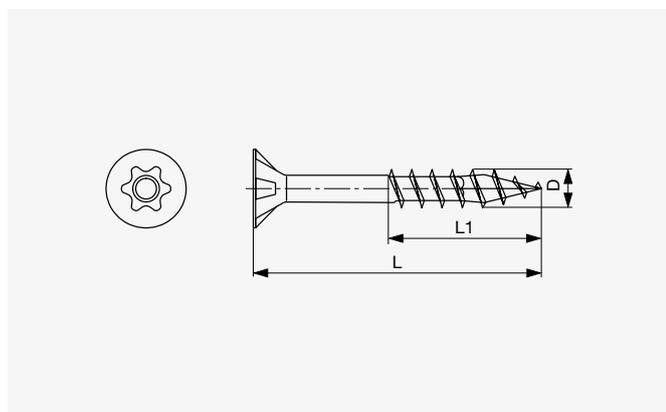
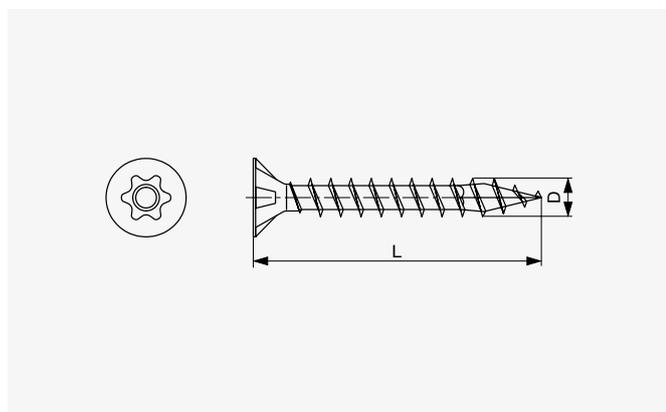

#### Cijela nit

Promjer D [mm]	Duljina L [mm]	Kod	Boja
3,0	16	F004205	Bijeli cink
	20	F004206	
3,5	16	F004207	
	20	F004208	
	25	F004209	
	30	F004210	
	35	F004211	
	50	F004212	
4,0	16	F004215	
	20	F004216	
	25	F004217	
	30	F004218	
	35	F004220	
	40	F004221	
	45	F004222	
	50	F004223	
5,0	50	F004225	
	60	F004226	
	70	F004227	
	80	F004228	

#### Pola niti

Promjer D [mm]	Duljina L [mm]	Kod	Duljina navoja L1 [mm]	Boja
4,0	30	F004219	18	Beli cink
	50	F004224	32	
	80	F004229	46	
5,0	80	F004230	61	
	100	F004231	61	
	120	F004232	69	
6,0	50	F004233	32	
	60	F004234	37	
	70	F004235	41	
	80	F004236	46	
	90	F004237	61	
	100	F004238	61	
	120	F004239	68	

## ● Spax spojni vijak sa zaobljenom glavom

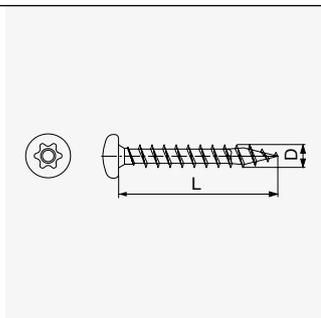

Promjer D [mm]	Duljina L [mm]	Nastavak	Kod	Boja
3,5	16	TX	F004262	Bijeli cink
4,0	16	TX	F004265	
		PZ	F004268	
4,5	16	TX	F004269	

## ● Spax spojni vijak Ravna kosa glava, dvostruki navoj – TX

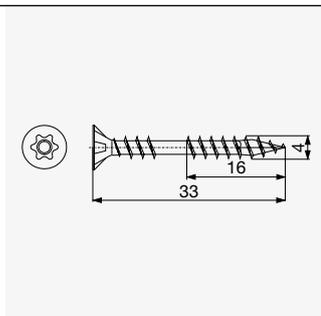

Promjer [mm]	Duljina [mm]	Kod	Boja
4,0	33	F004272	Bijeli cink

- Panela od 18 mm
- Savršeno povezuje ploče

## ● Spax vijci za MDF Ravna kosa glava – TX Drive

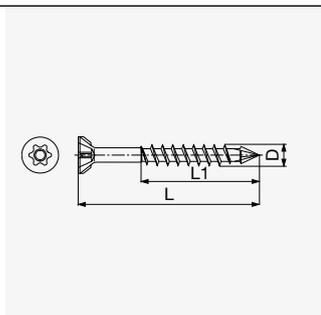

Promjer D [mm]	Duljina L [mm]	Kod	Duljina navoja L1 [mm]	Boja
3,5	50	F004274	35	Bijeli cink
4,0	50	F004275	35	
	60	F004276	40	
4,5	50	F004277	35	

## 14 ● Spax vijci za ivericu s prirubničkom glavom – TX

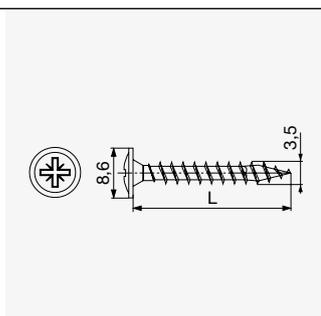

Promjer [mm]	Duljina L [mm]	Kod	Boja
3,5	17	F004282	Bijeli cink
	20	F004283	

## ● Spax vijci za puno drvo s ravnom glavom s kosim rezom – TX

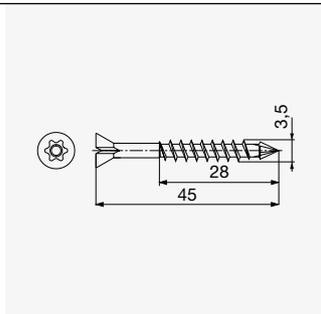

Promjer [mm]	Duljina [mm]	Kod	Duljina navoja [mm]	Boja
3,5	45	F004284	28	Bijeli cink

## ● Ukrasni Spax vijci za ivericu s prirubnicom s ravnom glavom – TX

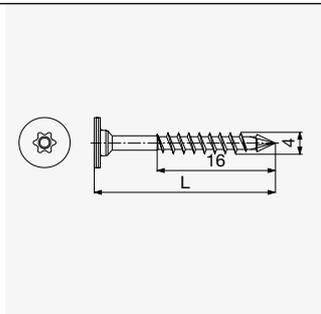

Promjer [mm]	Duljina L [mm]	Kod	Duljina navoja [mm]	Boja
4,0	30	F004285	16	Nikal
	34	F004286		

## ● IF Ukrasni vijci za ivericu s prirubnicom s ravnom glavom – PZ

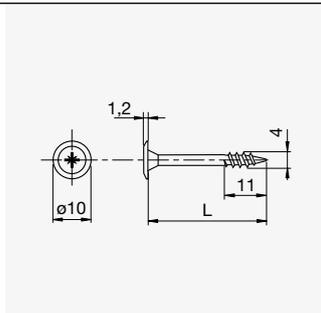

Promjer D [mm]	Duljina [mm]	Kod	Duljina navoja L1 [mm]	Boja
4,0	27	F003086	11	Nikal
	31	F003087		

## ● Spax bitovi TX



Duljina [mm]	Pogon	Kod
25	T10	F004292
	T15	F004293
	T20	F004294
	T30	F004296
50	T10	F004298
	T15	F004299
	T20	F004300
	T30	F004302

## ● Spax Bit PZ



Duljina [mm]	Pogon	Kod
25	PZ1	F004880
	PZ2	F004881
	PZ3	F004882
50	PZ1	F004883
	PZ2	F004884

## ● Spax TX Drive set bitova s magnetskim držačem



Duljina [mm]	Pogon	Kod
25	T10-T40	F004304

## 14 ● Spax Magnetski držač bitova



Tip	Kod
Magnetski	F004428

## ⊕ Riex Vijci

### Ravna kosina glava – PZ



● Bijeli cink



● Crno



● Poniklano



● Žuti cink

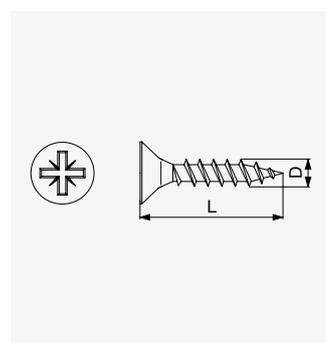

⊕ Puni navoj

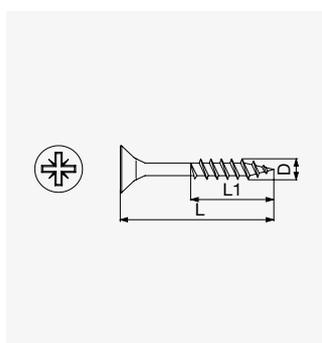

⊕ Pola navoja

### Celotna nit

Boja	Promjer D [mm]	Duljina L [mm]	Kod	
Crna	4,0	16	F003322	
		3,0	16	F001379
			20	F001380
			16	F001383
			18	F001384
			20	F001385
	25		F003306	
	Bijeli cink	3,5	30	F001386
			35	F003307
			40	F001387
			50	F001388
			16	F001389
18			F001390	
4,0		20	F001391	
		25	F001392	
		30	F001393	
		35	F001395	
		40	F001396	
		50	F001397	
Žuti cink	3,0	60	F001398	
		16	F001335	
		16	F001341	
		18	F001342	
		20	F001343	
		25	F001344	
	3,5	30	F001345	
		35	F001346	
		40	F001347	
		45	F001348	
		16	F001351	
		20	F001353	
4,0	25	F001354		
	30	F001355		
	35	F001357		
	40	F001358		
	45	F001359		
	50	F001360		
5,0	60	F001362		
	60	F001371		

### Pola niti

Boja	Promjer D [mm]	Duljina L [mm]	Kod	Duljina navoja L1 [mm]
Bijeli cink	4,0	33	F001394	14
		60	F001399	36
Rumeni cink	4,0	33	F001356	14
		60	F001363	36
	5,0	70	F001372	42

01  
02  
03  
04  
05  
06  
07  
08  
09  
10  
11  
12  
13  
14  
15  
16  
17  
18

## ⊕ Riex vijci s ravnom glavom – PZ

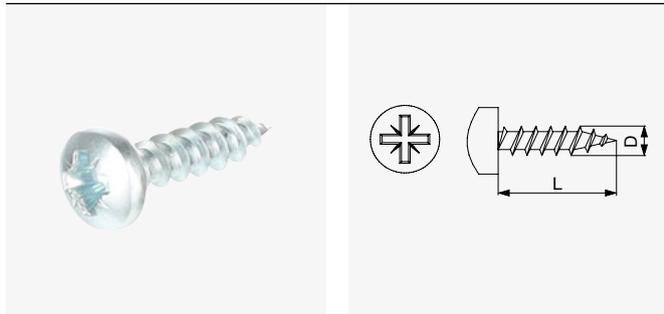

Promjer D [mm]	Duljina L [mm]	Kod	Boja
3,5	16	F001408	Bijeli cink
	16	F001410	
4,0	20	F001411	
	30	F003314	
5,0	50	F003315	

## ⊕ Riex vijci Ravna kosina glava – TX



● Bijeli cink Puni navoj

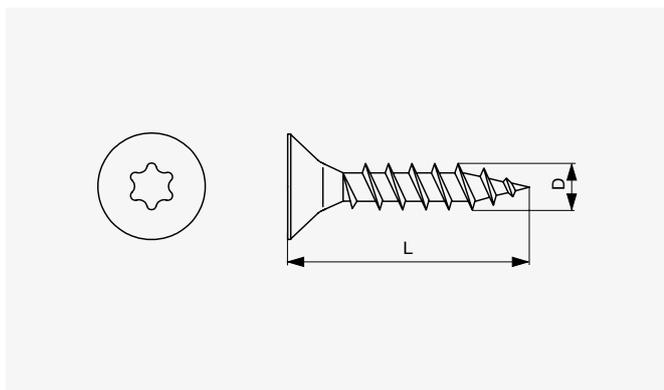

### Cijela nit

Promjer D [mm]	Duljina L [mm]	Kod	Boja
4,0	16	F003320	Crna
		F003319	Pokrito z nikljem
3,5	16	F003299	Bijeli cink
		F001316	
		F003300	
		F001317	
		F003301	
		F001318	
4,0	35	F001319	Bijeli cink
	40	F003302	
	16	F001321	
	18	F001322	
	20	F001323	
	30	F001325	
	35	F001326	
	40	F001327	
	50	F001329	
	60	F001330	

### Pola niti

Promjer [mm]	Duljina [mm]	Kod	Duljina navoja [mm]	Boja
4,0	33	F003305	14	Bijeli cink

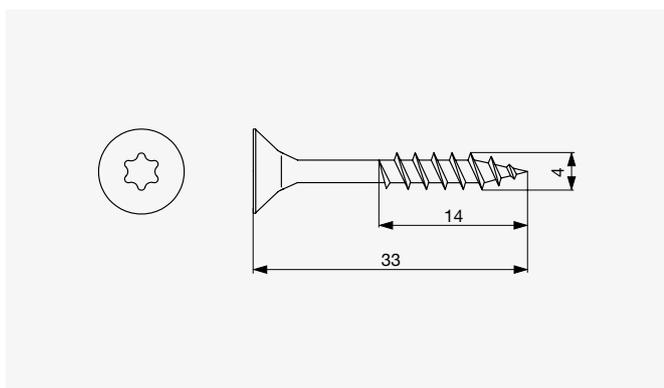



# Fischer nastavci – tiple

- Jedan od svjetskih lidera u području spajanja dva različita materijala
- Pouzdana rješenja za dug radni vijek

## ⓘ Potrebna duljina vijka dana je prema:

Duljina vijka [L] = duljina vijka [L1] + debljina ugradnje [T] + promjer vijka [D]

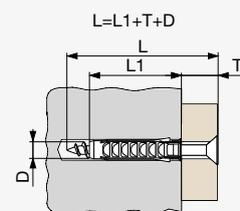

## ● Fischer DUOPOWER najlonski

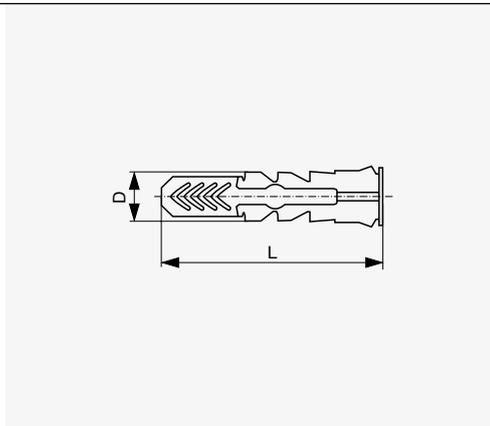

- Čep od dvokomponentnog materijala
- Odličan i jednostavan rad
- Građevinski materijal – masivni, rupičasti ili tanki materijal

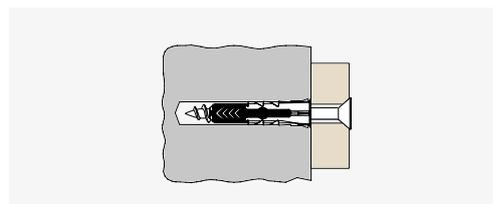

Promjer / izbušena rupa D [mm]	Duljina L [mm]	Kod	Min. dubina bušenja [mm]	Promjer vijka [mm]
5	25	F004372	35	3-4
6	30	F004373	40	4-5
	50	F004378	60	
8	40	F004374	50	4,5-6
	65	F004379	75	
10	50	F004375	70	6-8
	80	F004380	100	
12	60	F004376	80	8-10
14	70	F004377	90	10-12

## ● Fischer najlonska tipla SX

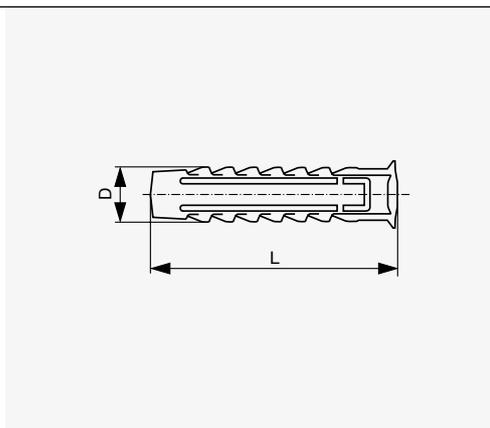

- Najlonska tipla sa 4 produžetka
- Za građevinski materijal

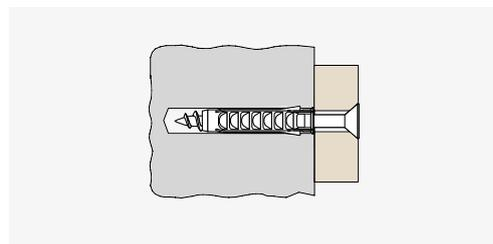

Promjer / izbušena rupa D [mm]	Duljina L [mm]	Kod	Min. dubina bušenja [mm]	Promjer vijka [mm]
6	30	F004362	40	4-5
	50	F004368	60	
8	40	F004363	50	4,5-6
	65	F004369	75	
10	50	F004364	60	6-8
	80	F004370	90	

## ● Fischer najlonska tipla UX

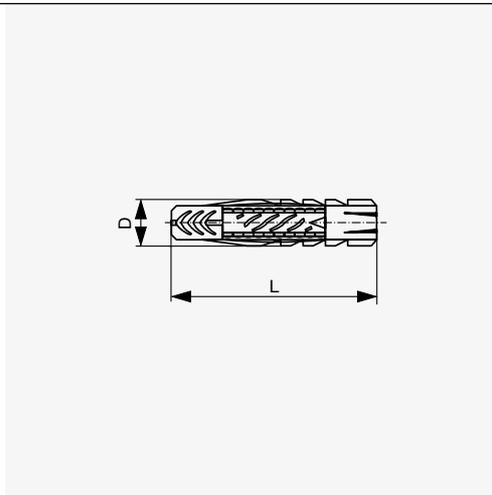

- Najlonska tipla za sve građevinske materijale
- Univerzalni princip rada [čvor ili razvlačenje] omogućuje primjenu u svim masivnim, šupljim i ravnim građevinskim materijalima.

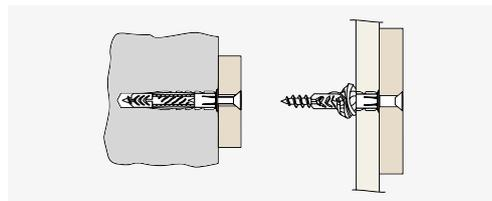

Promjer / izbušena rupa D [mm]	Duljina L [mm]	Kod	Min. dubina bušenja [mm]	Promjer vijka [mm]
5	30	F004381	40	3-4
6	35	F004382	45	4-5
	50	F004391	60	
8	50	F004383	50	4,5-6
10	60	F004384	70	6-8
12	70	F004385	80	8-10
14	75	F004386	85	10-12

## ● Fischer UX najlonska tipla s RIM-om

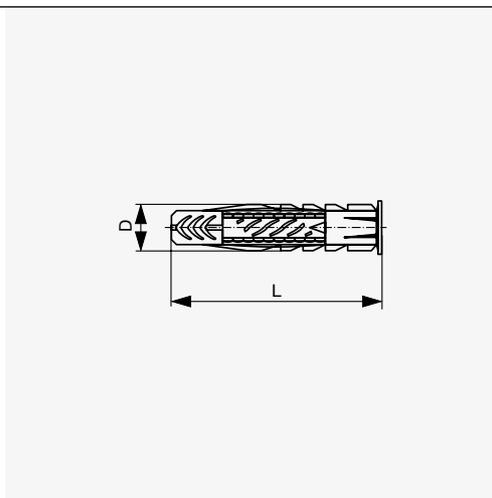

- Univerzalna tipla
- Građevinski materijal – čvrsta, perforirana

Promjer / izbušena rupa D [mm]	Duljina L [mm]	Kod	Najmanjša globina vrtine [mm]	Promjer vijaka [mm]
5	30	F004387	40	3-4
6	35	F004388	45	4-5
	50	F004392	60	
8	50	F004389	60	4,5-6
10	60	F004390	70	6-8

01  
02  
03  
04  
05  
06  
07  
08  
09  
10  
11  
12  
13  
14  
15  
16  
17  
18

## ● Fischer

## Dilatacijski tipl GB za razne spojeve u porobetonu

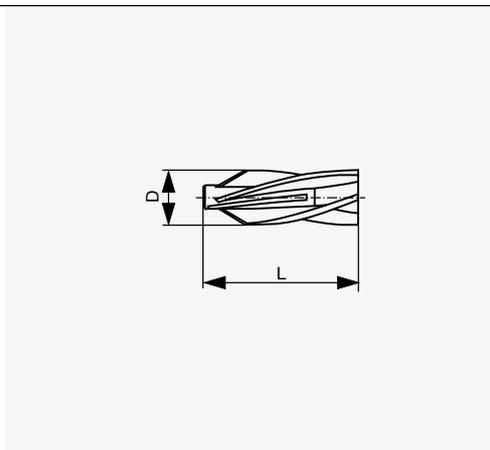

- Spiralna vanjska rebra dobro pristaju uz mekani građevinski materijal
- Može se koristiti s čekićem

Promjer / provrt D [mm]	Duljina L [mm]	Kod	Minimalna dubina bunara [mm]	Promjer vijka [mm]
8	50	F004393	60	5
10	55	F004394	65	7

## ● Fischer

## DUOTEC sklopiva tipla za različite debljine ploča

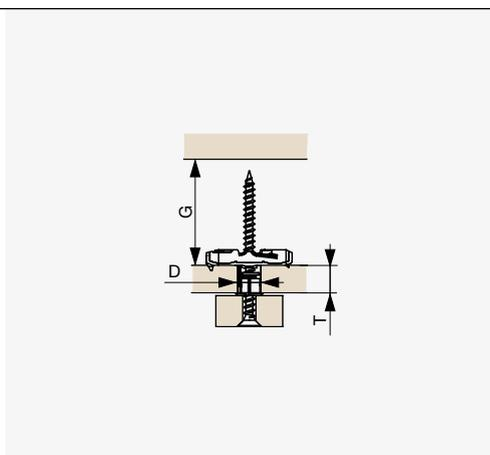

- Podesivi navojni nosač olakšava korištenje vijci i kuke s različitim vrstama navoja
- Min. duljina vijka = debljina ploče + debljina žice + 20 mm



Promjer / izbušena rupa [mm]	Kod	Min. debljina ploče T [mm]	Najveća debljina ploče T [mm]	Min. dubina udubljenja G [mm]	Promjer vijaka [mm]
10	F004401	12	55	40	4,5-5
12	F004402	12	55	50	5-6 / M6

## ● Fischer Sklopiva tipla KD za različite debljine ploča

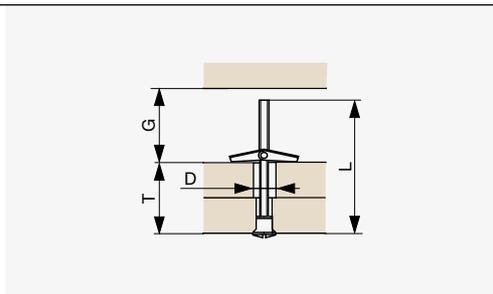

- Univerzalno pričvršćivanje za pričvršćivanje u širokom rasponu materijala za suhozidne i šuplje zidove

Ⓢ F004397

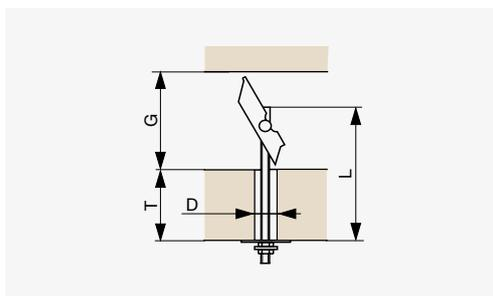

Ⓢ F004398

Nit	Kod	Promjer / izbušena rupa D [mm]	Min. debljina ploče T [mm]	Min. dubina udubljenja G [mm]
M3 × 90	F004396	12	65	27
M4 × 100	F004397	14	69	34
M5 × 100	F004398	16	63	70
M6 × 100	F004399	16	63	70
M8 × 100	F004400	20	55	75

## ● Fischer Učvršćivanje balkonske obloge P9K

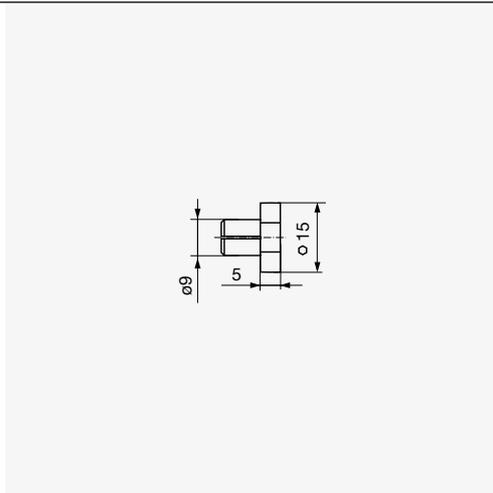

- Idealan za postavljanje balkonske obloge na šuplje profile
- Između profila i ploče stvara se razmak od 5 mm

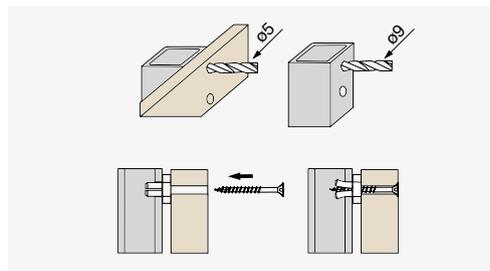

Promjer rupe D [mm]	Kod	Promjer vijka [mm]	Visina ovratnika [mm]
9	F004890	5	5

01  
02  
03  
04  
05  
06  
07  
08  
09  
10  
11  
12  
13  
14  
15  
16  
17  
18

## ● Fischer Popravljanje TB / TBB

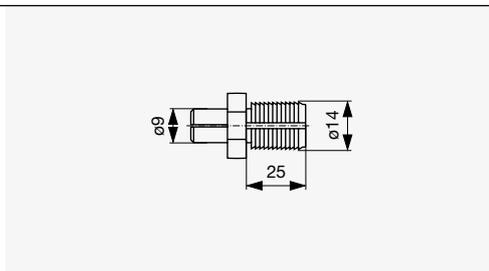

- Za pričvršćivanje drvenih stepenica na betonske i čelične podkonstrukcije
- Elastična geometrija osovine omogućuje apsorpciju vibracija, sprječava škripanje i time povećava udobnost

① Za šuplje čelične profile

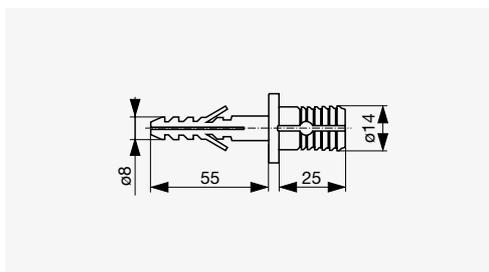

② Za čvrste građevinske materijale

Vrsta instalacije	Kod	Otvor za radni stol na stubištu [mm]	Otvor za montažni materijal [mm]	Vijak [mm]
Za šuplje čelične profile	F004891	ø14 × 25	ø9	ø5 × 40
Za čvrste građevinske materijale	F004892	ø14 × 25	ø8 × 55	ø5,5 × 70

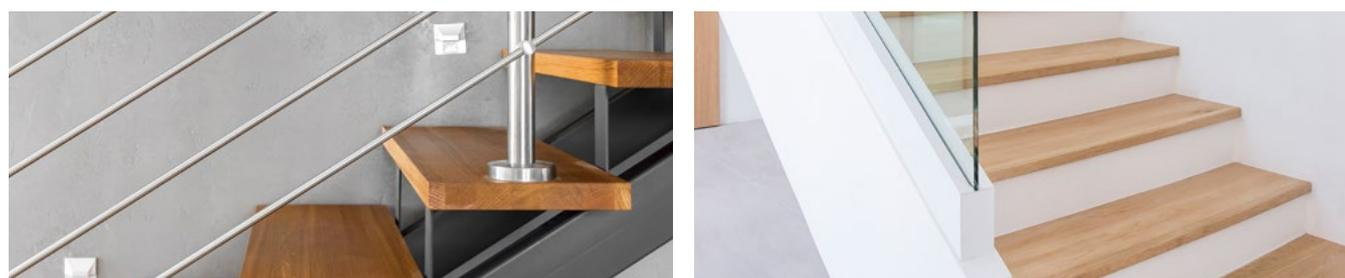
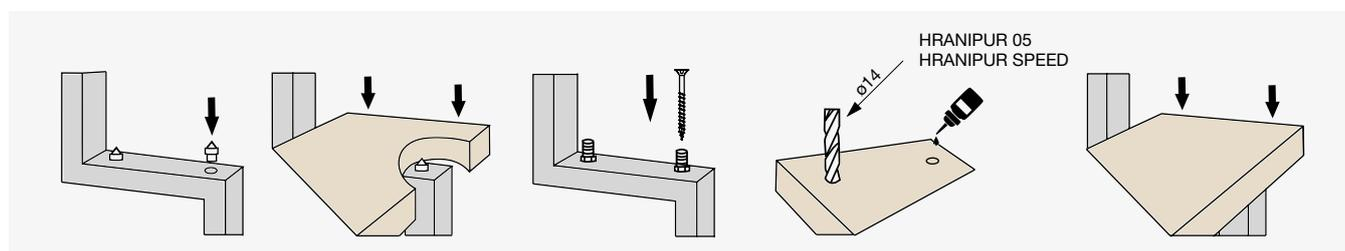

14

## ● Fischer TBZ 2 marker igla



Tip	Kod
Marker	F004893

# Riex konfirmat vijci i eurovijci

## ⊕ Riex JD65 Konfirmat vijak HEX

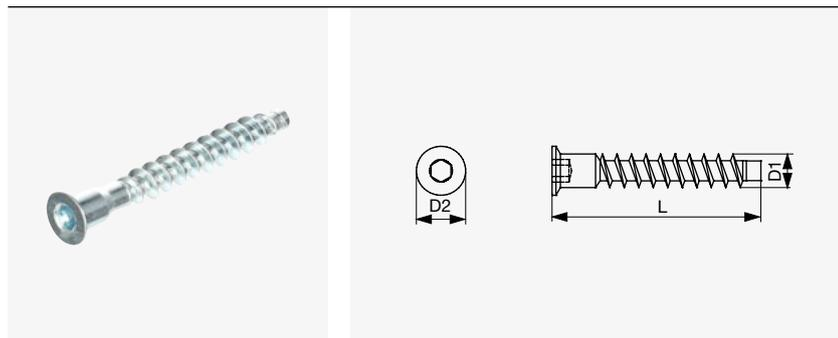

Promjer D1 [mm]	Duljina L [mm]	Kod	Promjer D2 [mm]	Boja
5	50	F002021	9	Bijeli cink
6,4	50	F002022	10	
7	50	F001806	11	
	70	F002024		

## ⊕ Riex JD60 Eurovijci

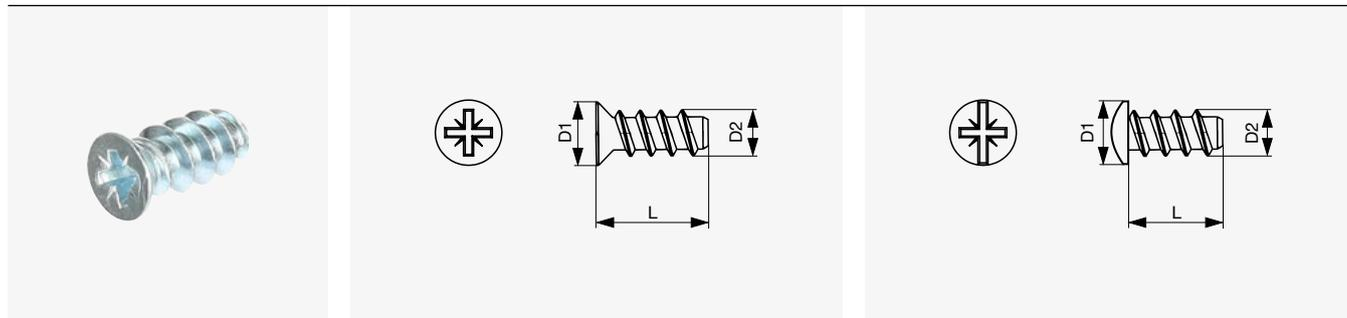

⊕ F001789

⊕ F001789, F001790

⊕ F004505

Promjer D2 [mm]	Promjer glave D1 [mm]	Kod	Duljina L [mm]	Boja
6,3	7	F001789	13	Bijeli cink
	8	F001790		
	9	F004505		

## ● SPAX

## Svrđlo za predbušenje

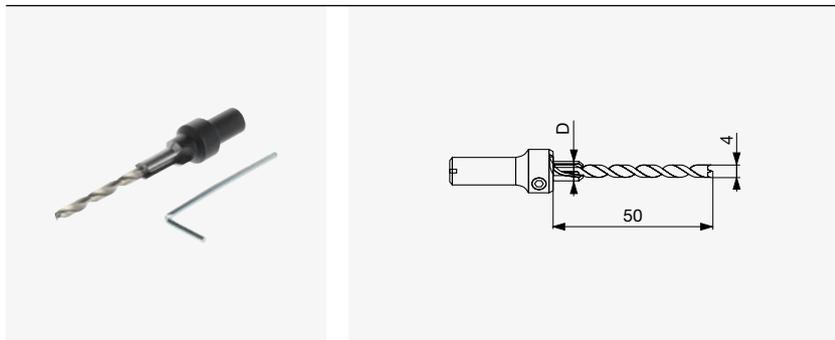

Promjer D [mm]	Kod	Duljina [mm]
6,3	F004305	50
7	F004427	



# Spojni vijci, matice i priključci za radnu površinu

## ⊕ Riex JD20 Spojni vijci

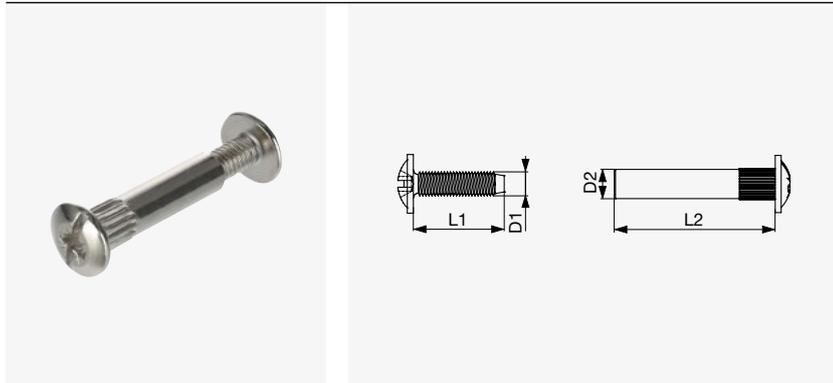

Promjer D1 [mm]	Kod	Debljina ploče [mm]	Vijak L1 [mm]	Matica L2 / D2 [mm]	Nastavak	Boja
M4	F001799	30-39	14	29 / 4,9	PZ	Poniklano
M6	F001800			29 / 7,5		

## ⊕ Riex JD14 Vijci za ručke

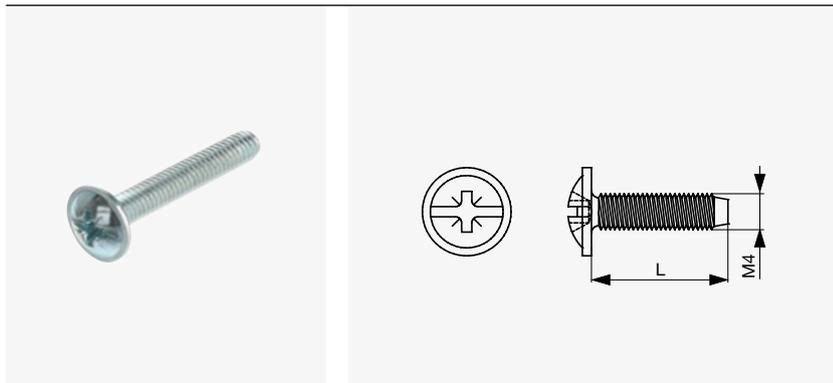

Promjer	Dužina L [mm]	Kod	Nastavak	Boja
M4	20	F001807	PZ	Bijeli cink
	22	F001808		
	25	F001809		
	40	F001810		

### ● IF Priključak za gornju radnu površinu za tanke ploče

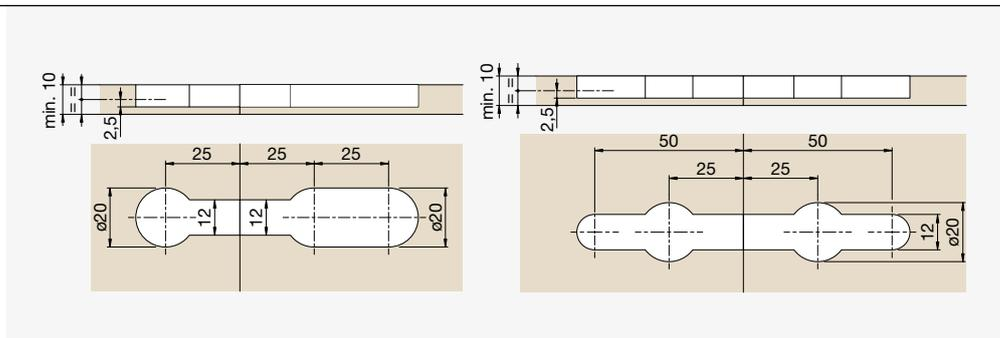

Debljina ploče [mm]

Kod

Duljina [mm]

min. 10

F004667

50

### ● AKO Brzo Priključci za radnu površinu

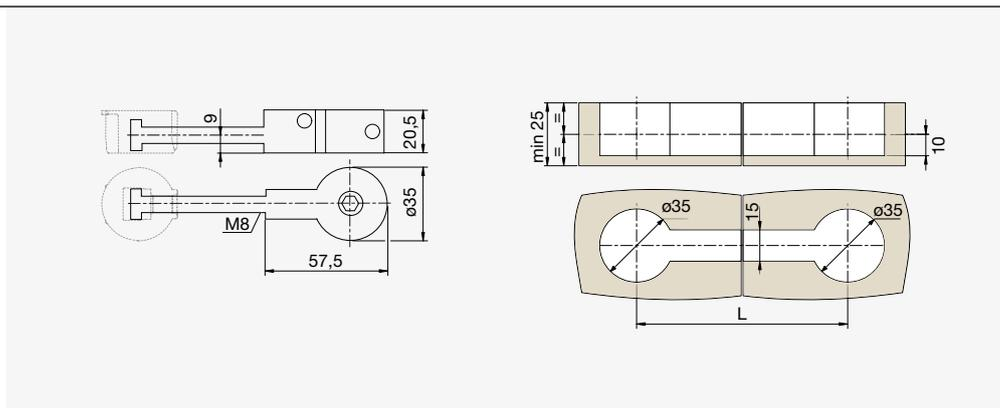

① Konektor

① F002698, F002699, F002700

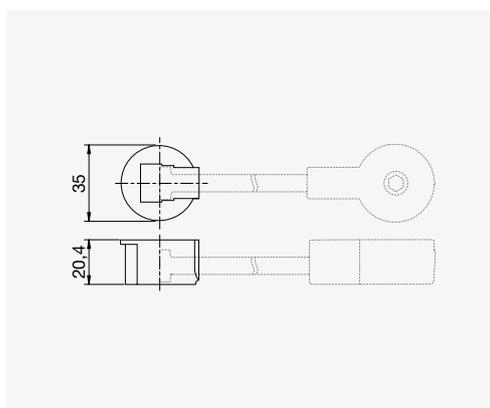

① Okrugla kapa

① F002701

Za komplet se mora uzeti konektor i okrugla kapica.

- Jednostavna i brza montaža dva dijela radne ploče
- Fokus je 6 mm
- Jednostavna i brza montaža pomoću ključa od 6 mm
- Akumulatorska bušilica

14

Tip	Duljina L [mm]	Kod
Konektor	64	F002698
	100	F002699
	150	F002700
Okrugla kapa	x	F002701

## ⊕ Riex JC31

### Konektori za radnu površinu

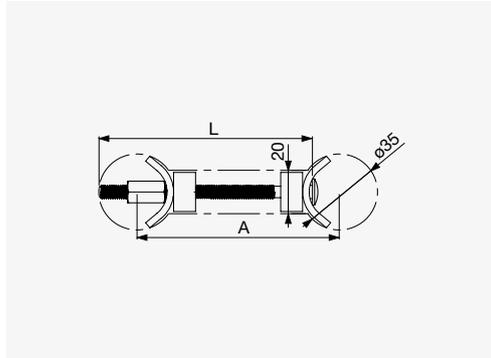

Duljina L [mm]	Kod	A Min / Maks [mm]
65	F001822	32 / 38
120	F001823	59 / 65
150	F001824	74 / 80

## ⊕ Riex JC30

### Umetnuta matrica

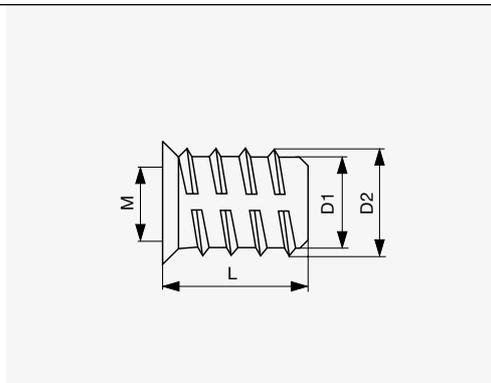

Unutarnji navoj M	Kod	Promjer D1 / D2 [mm]	Duljina L [mm]	Boja
M6	F002530	8 / 9,5	13	Bijeli cink
M8	F002531	10 / 12	15	
M10	F002532	12 / 15	18	

**⊕ Riex JC36**  
**Najlonska tipla za drvo**

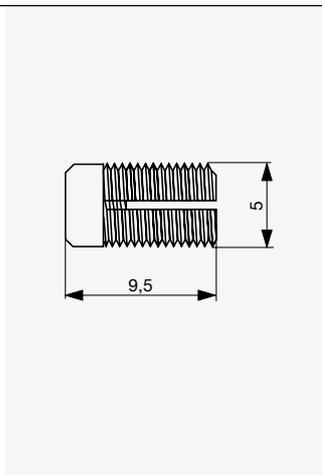

Promjer rupe [mm]	Promjer vijka [mm]	Kod	Boja
5	3,5	F002536	Bijela

**⊕ Riex JC32**  
**Plastična ekspanzivna matrica**

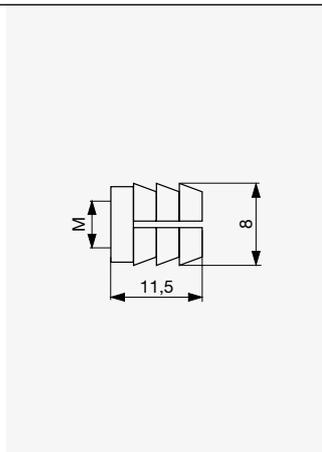

Unutarnji navoj M	Kod	Boja
M4	F002534	Bijela
M6	F002535	

**⊕ Riex JC38**  
**Mesingana ekspanzivna matrica**

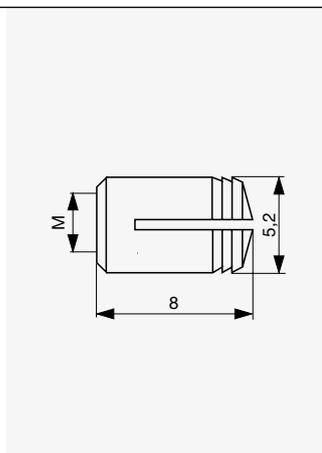

Unutarnji navoj M	Kod	Boja
M4	F002533	Mjed

14

## ⊕ Riex JC11 T-vijak

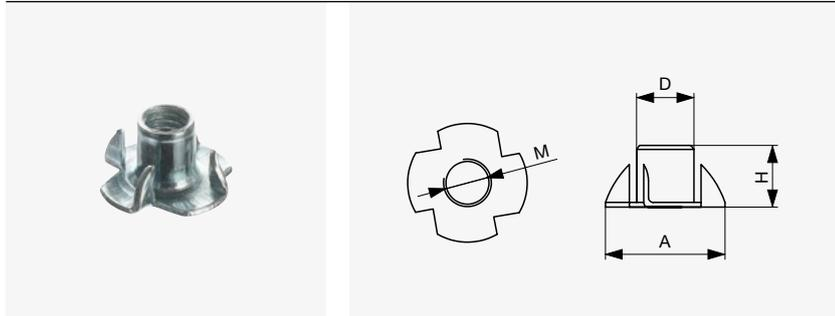

Dimenzija M	Kod	Promjer A [mm]	Visina H [mm]	Promjer D [mm]	Boja
M6	F002842	19	9	7,3	Bijeli cink
M8	F002843	22	10	9,6	
M10	F002844	25	12	11,5	

## ⊕ Riex JD38 Podloška ispod vijka

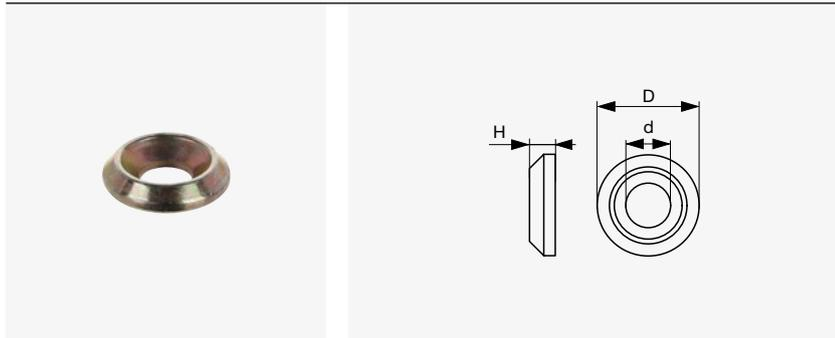

Dimenzija	Kod	Promjer D / d [mm]	Višina H [mm]	Boja
D6	F004337	8 / 20	4,4	Žuti cink
D8	F004338	8,5 / 25	5,5	

## ⊕ Riex JD33 Navojna šipka dužine 1 m



Dimenzija	Kod	Boja
M6	F004333	Bijeli cink
M8	F004334	

# Ekscentrične spojnice

## ⊕ Riex JC15 CAM kućište

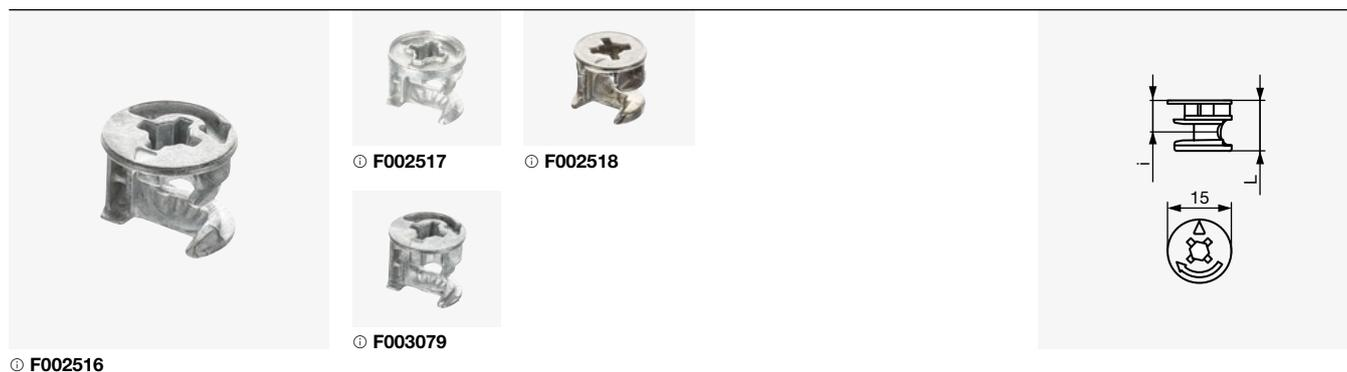

⊕ F002516

⊕ F002517

⊕ F002518

⊕ F003079

Debljina materijala [mm]	Boja	Visina boje L [mm]	Kod	Promjer [mm]	Položaj zatika i [mm]
15-16	Bijeli cink	12	F002516	15	7,75
18-19	Bijeli cink	12,7	F002517		8,5
	Poniklavanje	13,8	F002518		9
	Bijeli cink	13,5	F003079		9,3

## ⊕ Riex JC25 CAM klin s plastičnim prstenom PZ



⊕ F002519

⊕ F002520

⊕ F002521

Priključak MD	Razmak bušenja i [mm]	Kod	Promjer [mm]	Duljina L [mm]
Eurocrew	34	F002519	7,5	11
	24	F002520		8
M6	34	F002521		

## ⊕ Riex JC25 CAM klin Metalni centralni dio PZ

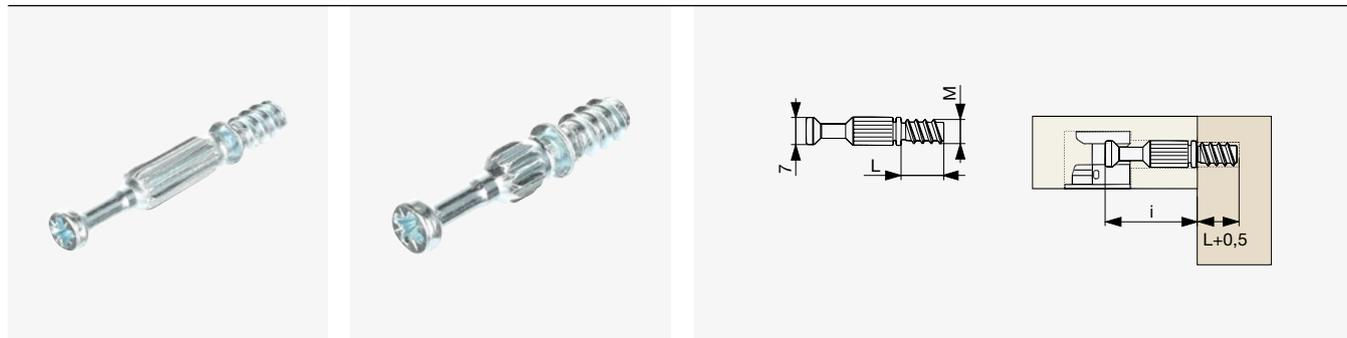

⊙ F002522

⊙ F002523

Priključak MD	Razmak bušenja i [mm]	Kod	Promjer [mm]	Duljina L [mm]
Eurocrew	34	F002522	7	11
	24	F002523		

## ⊕ Riex JC25 CAM tipla za brzo otpuštanje

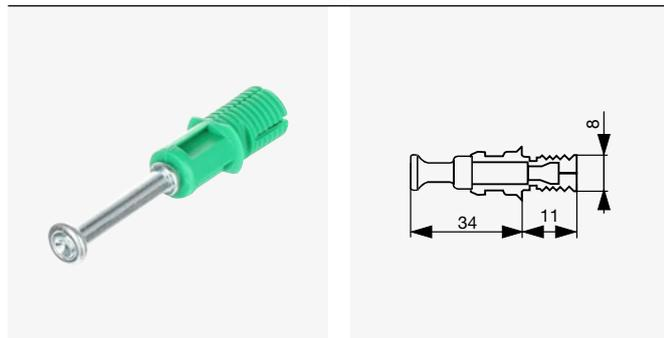

- Brza montaža bez uvrtnja
- Isti promjer rupe kao standardni drveni čavli = ušteda vremena

Veza	Udaljenost bušenja ja [mm]	Kod	Promjer [mm]	Duljina [mm]
Zatik za proširenje	34	F002524	8	11

### ⊕ Riex JC25 CAM dvostruki klin



⊕ F002525



⊕ F002526

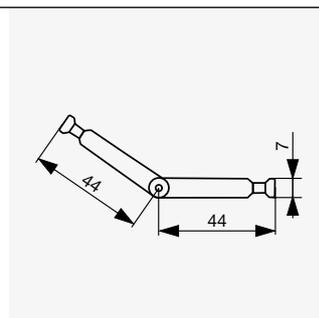

⊕ F002525

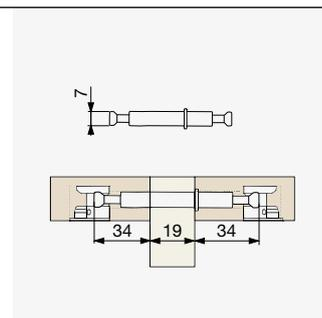

⊕ F002526

Promjer [mm]	Tip	Kod
7	Kutni	F002525
	Označeno	F002526

### ⊕ Riex JC28 za spoj matice – vijak



⊕ F002527



⊕ F002528

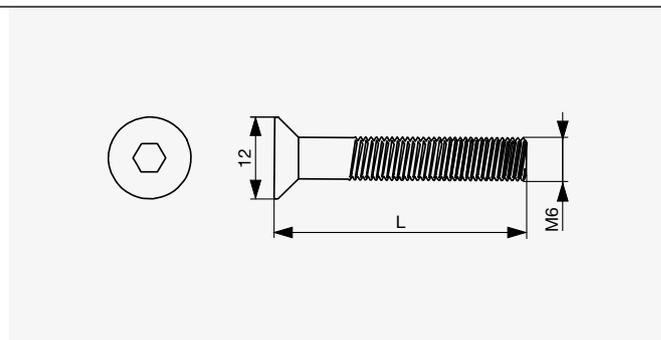

Promjer [mm]	Duljina L [mm]	Kod	Nastavak
M6	60	F002527	HEX
	50	F002528	

### ⊕ Riex JC28 konektor – matica

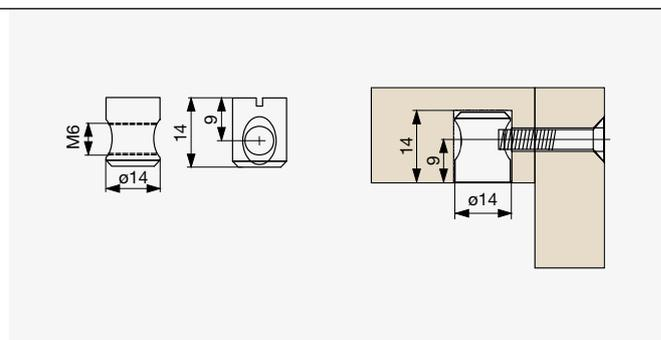

Metrički kod otvora	Kod	Dubina [mm]	Promjer [mm]
M6	F002529	14	14



# Drvene tiple

## ⊕ Riex JW55 Drvene tiple – kalibrirane

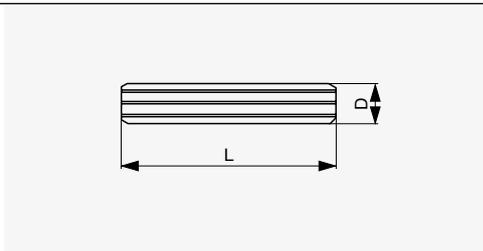

Promjer D [mm]	Duljina L [mm]	Kod	Drvene	Ambalaže
6	30	F002503	Stablo breze	1000
	35	F002504		1000
8	30	F002496		10000
	35	F002497		8650
	40	F002498		7600
	50	F002508		1000
	60	F002509		1000
10	40	F002510		1000
	50	F002511		1000
12	50	F002512		1000

\* Kalibrirane tiple prikladni su za automatsku proizvodnju zbog svoje točnosti.

## ⊕ Riex JW31 Drvene tiple – nekalibrirani

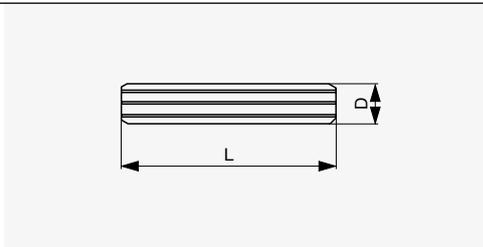

Promjer D [mm]	Duljina L [mm]	Kod	Vrsta drva	Pakiranje
8	30	F004936	Bukva	1 kg [ +/- 930 komada ]
	35	F004937		1 kg [ +/- 845 komada ]
	40	F004938		1 kg [ +/- 770 komada ]

### ⊕ Riex JW55 drvene tiple s ljepilom – kalibrirani

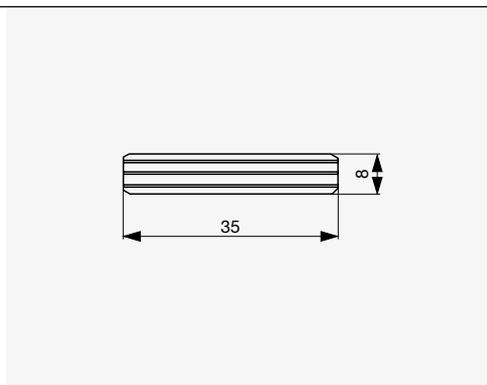

- Ljepilo na brazdama se aktivira vodom
- Zbog svoje točnosti kalibrirani tiple prikladni su i za automatsku proizvodnju
- Ljepilo na bazi vode omogućuje čišću automatsku i ručnu izradu

Promjer [mm]	Duljina [mm]	Kod	Vrsta drva	Pakiranje +/-
8	35	F002502	Breza	8650

### ⊕ Riex JW52 1 m rebrasta drvena tipla

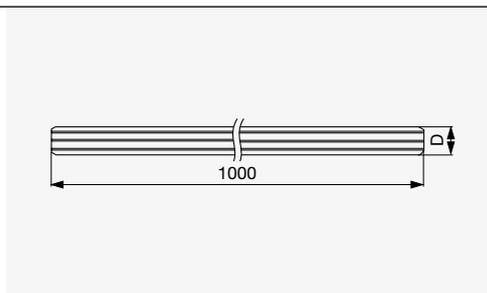

Promjer D [mm]	Kod	Vrsta drva
6	F004939	Bukva
8	F002513	
10	F002514	
12	F002515	

### ⊕ Riex JW42 Drveni umetak

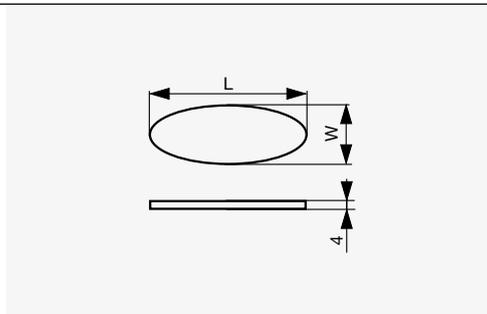

Veličina	Kod	Duljina L [mm]	Široki W [mm]	Debljina [mm]	Vrsta drva
0	F004422	47	15	4	Bukva
10	F004423	53	19		
20	F004424	56	23		

## ⊕ Riex JW12 Drvene zakrpe [čvorovi]

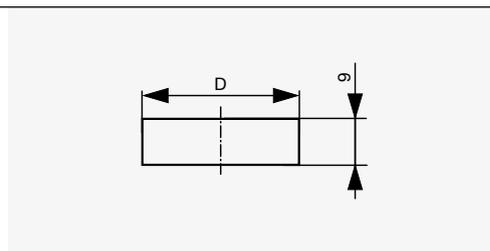

Vrsta drva	Promjer D [mm]	Kod
Smreka	15	F004410
	20	F004412
	25	F004414
	30	F004416
	35	F004418
Bor	15	F004420

## ⊕ Riex JW13 umetak

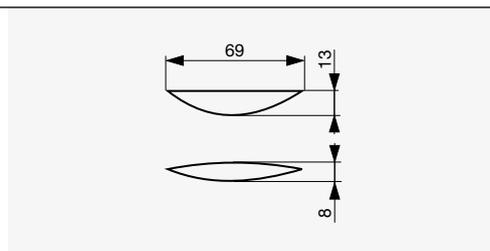

⊕ Smreka

Vrsta drva	Kod	Dimenzija [mm]
Smreka	F004425	8 × 13 × 69
Bor	F004426	

## ⊕ Riex JW10 Drveni čep

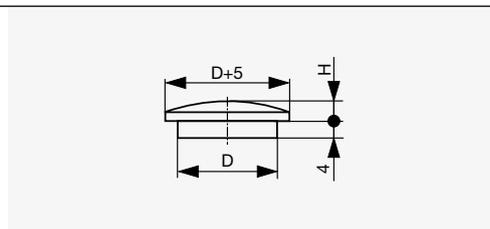

⊕ Smreka

Vrsta drva	Promjer D [mm]	Kod	Visina H [mm]
Bukva	10	F004403	3
	15	F004406	4
	35	F004408	6
Hrast	15	F004407	4
	35	F004409	6
Smreka	15	F004404	4
Bor	15	F004405	4

# Samoljepljive kapice

- Izrađen od Hranipex rubnih traka [identitet boja]
- ABS materijal
- Promjer 20 i 14 mm
- Debljina 0,45 mm
- Jednostavne boje i drveni dekori

## Samoljepljive kapice Riex JS10 20 mm

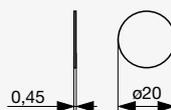

- Jedan list sadrži 9 komada

	Boja	Površina	Kod		Boja	Površina	Kod
	Bijela [101027]	Glatko	F005037		Jelša [23685]	Pore	F005079
	Bijela [10113]	Glatko	F005040		Hrast [241145]	Pore	F005085
	Bijela [10113]	Pearl	F005041		Hrast [243145]	Pore	F005089
	Bijela [10482]	Glatko	F005042		Hrast [248431]	Pore	F005103
	Bijela [10980]	Glatko	F005045		Kamniti brest [25364]	Pearl	F005110
	Slonova kost [12514]	Pearl	F005048		Bijeli dresnik [254032]	Pore	F005111
	Siva [17014]	Pearl XG	F005053		Javor [260375]	Pore	F005118
	Siva [17035]	Pearl G	F005055		Pepelni preludij [262040]	Pore	F005121
	Siva [170540]	Pearl	F005057		Pepel [263843]	Pore	F005127
	Antracit [17164]	Pearl	F005061		Oreh Toskanija [283453]	Pearl	F005141
	Crna [19015]	Pearl	F005068		Orehovi tobak [283702]	Pearl	F005142
	Bukev [210381]	Pore	F005070				

## Samoljepljive kapice Riex JS10 14 mm



• Jedan list sadrži 25 komada

Boja	Površina	Kod	Boja	Površina	Kod
 Bijela [101027]	Glatko	F005035	 Cherry antik [228944]	Pearl	F005076
 Bijela [101027]	Pearl	F005036	 Gorska jelša [234634]	Pore	F005077
 Bijela [10113]	Glatko	F005038	 Jelša [23685]	Pore	F005078
 Bijela [10113]	Pearl	F005039	 Bijeli hrast [24001]	Pore	F005080
 Bijela [10980]	Glatko	F005043	 Sivi hrast [24002]	Pore	F005081
 Bijela [10980]	Pearl	F005044	 Zlati hrast [24003]	Pore	F005082
 Slonova kost [12514]	Pearl	F005046	 Hrast [24005]	Pore	F005083
 Slonova kost [12514]	Pearl XG	F005047	 Temni hrast [240296]	Pore	F005084
 Bež [12522]	Pearl	F005051	 Hrast cremona [241394]	Pearl	F005086
 Siva [17014]	Pearl	F005052	 Oak paris [243127]	Pore	F005087
 Siva [17035]	Pearl	F005054	 Hrast [243145]	Pore	F005088
 Siva [170540]	Pearl	F005056	 Reški hrast [243167]	Pore	F005090
 Siva [17112]	Pearl	F005058	 Hrast [243197]	Pore	F005092
 Temno siva [171257]	Pearl	F005059	 Oak sonoma [243215]	Pore	F005093
 Antracit [17164]	Pearl	F005060	 Hrast [243786]	Pore	F005094
 Temno siva [172162]	Pearl	F005062	 Rustikalni hrast [244129]	Pore	F005097
 Siva [17860]	Pearl	F005063	 Pješčani hrast [244139]	Pore	F005098
 Cappuccino [18205]	Pearl	F005064	 Bronasti hrast [244141]	Pore	F005099
 Tartufovo rjava [18748]	Pearl G	F005065	 Tobačni hrast [244216]	Pore	F005100
 Crna [19015]	Glatko	F005066	 Naravni hrast [244303]	Pore	F005101
 Crna [19015]	Pearl	F005067	 Hrast [248431]	Pore	F005102
 Bukev [210381]	Pore	F005069	 Borovnica [251484]	Pore	F005104
 Bukev [215111]	Pore	F005072	 Naravna tortona [251796]	Pore	F005105
 Češnja [220344]	Pore	F005073	 Elm adagio [253191]	Pore	F005106
 Calvados [222951]	Pearl	F005074	 Elm advante [253192]	Pore	F005107
 Češnjev tobak [223657]	Pearl	F005075	 Elm moderato [253193]	Pore	F005108

	Boja	Površina	Kod		Boja	Površina	Kod
	Limba [253381]	Pore	F005109		Srebro [29509]	Pearl	F005157
	Lava Elm [254055]	Pore	F005112		Tikovina [295852]	Pore	F005158
	Limba crna [254080]	Pore	F005113		Crni wook [298509]	Pore	F005159
	Limba duhan [254081]	Pore	F005114				
	Lagani limba [254082]	Pore	F005115				
	Elm [255112]	Pearl	F005116				
	Javor [260375]	Pore	F005117				
	Javor [261521]	Pearl	F005119				
	Preludij od pepela [262040]	Pore	F005120				
	Pepeljasto bijela [262460]	Glatko	F005122				
	Ash Nobel [262577]	Pearl	F005123				
	Pepeljugina sonata [263041]	Pore	F005124				
	Verona jasen [263158]	Pore	F005125				
	Pepeo [263843]	Pore	F005126				
	Pepeo [264042]	Pore	F005128				
	Snježna breza [271715]	Pearl	F005129				
	Orah [280722]	Pore	F005131				
	Wenge [282229]	Pearl	F005132				
	Orah [283102]	Pore	F005135				
	Prodaja oraha [283105]	Pore	F005136				
	Oraha [283106]	Pore	F005137				
	Wenge [283227]	Pearl	F005138				
	Toskanski orah [283453]	Pearl	F005140				
	Tamni mahagonij [28466]	Pore	F005144				
	Oraha [284704]	Pearl	F005145				
	Orah [28476]	Pearl	F005146				
	Orah [288450]	Pore	F005148				
	Candiano orah [288918]	Pearl	F005149				
	Titan [290501]	Pearl	F005150				
	Treeline [291424]	Pore	F005151				
	Svijetla hacienda [293078]	Pore	F005152				
	Tamna Hacienda [293081]	Pore	F005153				
	Sherwood tamno [293141]	Pore	F005154				
	Morske alge [293298]	Pearl	F005156				

# Vješalice za ormare

## ● Riex JK40 Podesiva vješalica za ormariće

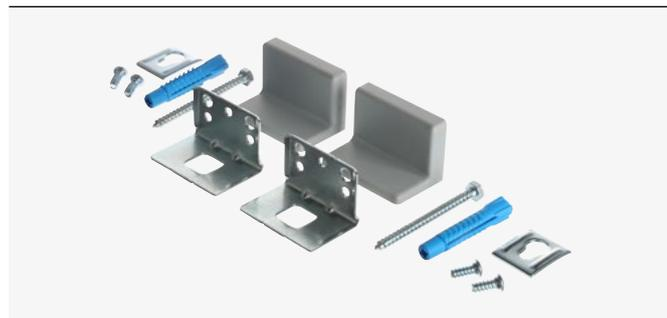

● Siva



○ Bijelo

● Smeđa

- Uključite dodatke
- Pakiranje od 2 seta
- Podešavanje visine  $\pm 5$  mm
- Bočno podešavanje  $\pm 3,5$  mm



● Crna

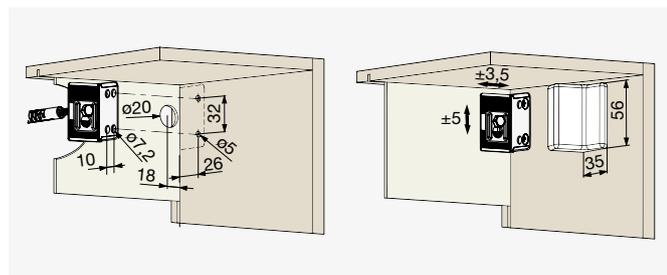

Boja	Kod
Bijela	F002838
Smeđa	F002839
Crna	F002840
Siva	F002903

## ● Riex JK41 Podesiva vješalica za ormariće



○ Bijela



● Smeđa

● Svijetlo smeđa

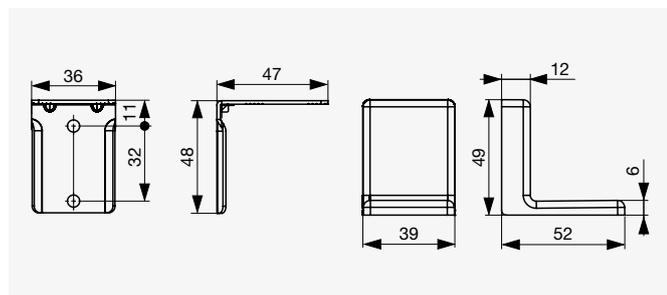

Boja	Kod
Bijela	F004671
Smeđa	F004672
Svijetlo smeđa	F004673

## ⊕ Riex JK42

### Podesivi zaokretni umetak za nosač elementa

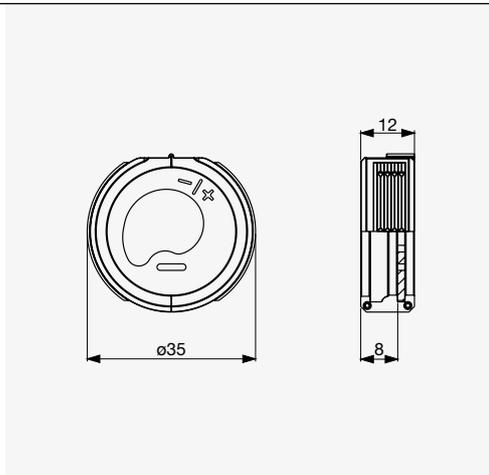

**Podešavanje:**

- Okomito  $\pm 5$  mm
- Može se objesiti na glavu vijka

Boja	Kod	Promjer [mm]
Crno	F002841	35

## ⊕ Riex JK44

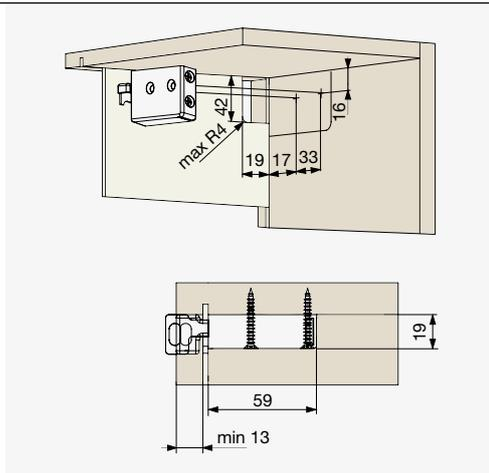
### Univerzalni podesivi nosač elementa



- Visi s obje strane
- 1 u pakiranju

**Podešavanje:**

- Okomito  $\pm 5$  mm
- Dubina  $\pm 5$  mm
- Nosivost 25 kg / kom
- Koristite s bilo kojom vrstom šipke za vješanje na zid [na str. 14.36]

Boja	Kod
Bijela	F002865

## ⊕ Riex JK46

### Podesivi nosač elementa

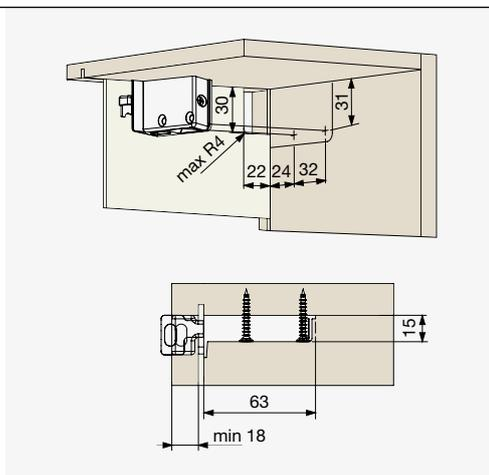

**Podešavanje:**

- Okomito  $\pm 10$  mm
- Dubina  $\pm 7,5$  mm
- Nosivost 35 kg / kom
- Koristite s bilo kojom vrstom šipke za vješanje na zid [na str. 14.36]

Boja	Kod	Stranica
Bijela	F003453	Lijevo
	F003454	Desno

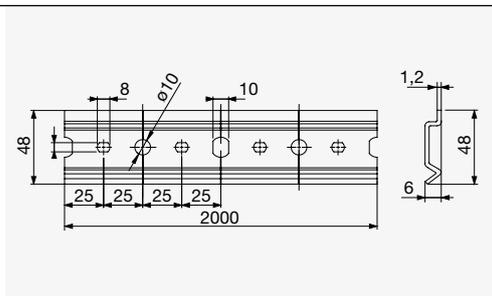

## Šipka za vješanje Riex JK48



F003020

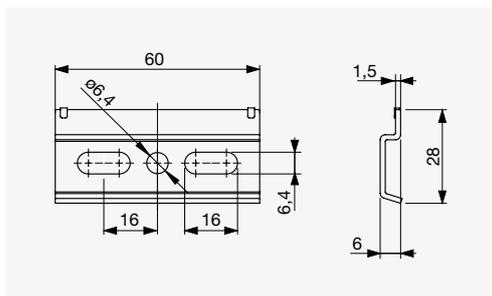

F003021

Duljina [mm]	Kod	Debljine [mm]
2000	F003020	1,2
60	F003021	1,5

## Viseći nosač Riex JC53

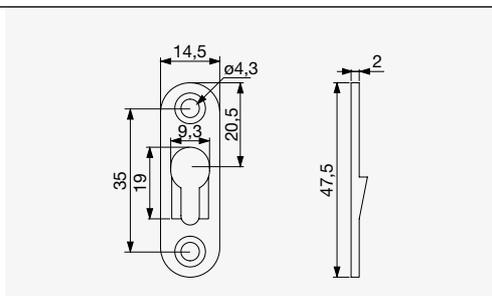

Boja	Kod
Bijeli cink	F004312

## Riex JK48 L Vijak

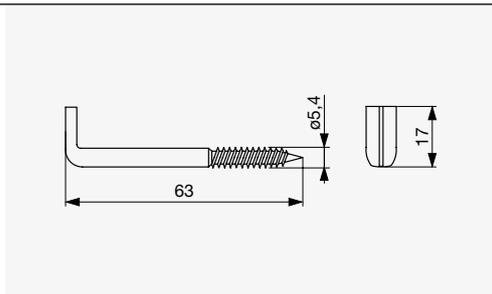

Mjera [mm]	Kod
$\phi 5,4 \times 63$	F003022

## ● IF Libra H7 Vješalica za ormare

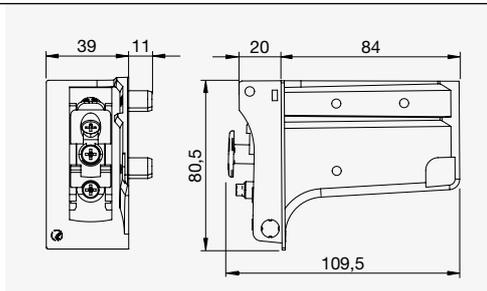

- LIBRA H7 je univerzalna vješalica za ormare vrlo velike nosivosti
- Okomito podešavanje  $\pm 6,5$  mm
- Podešavanje dubine  $\pm 6$  mm
- Sustav zaključavanja protiv okretanja
- Tanke stranice za sprječavanje sudaranja ladica
- Nosivost do 200 kg po setu sa šipkom F003289

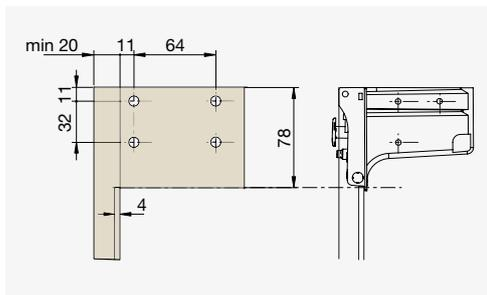

Tip	Kod
Sa iglama	F002705

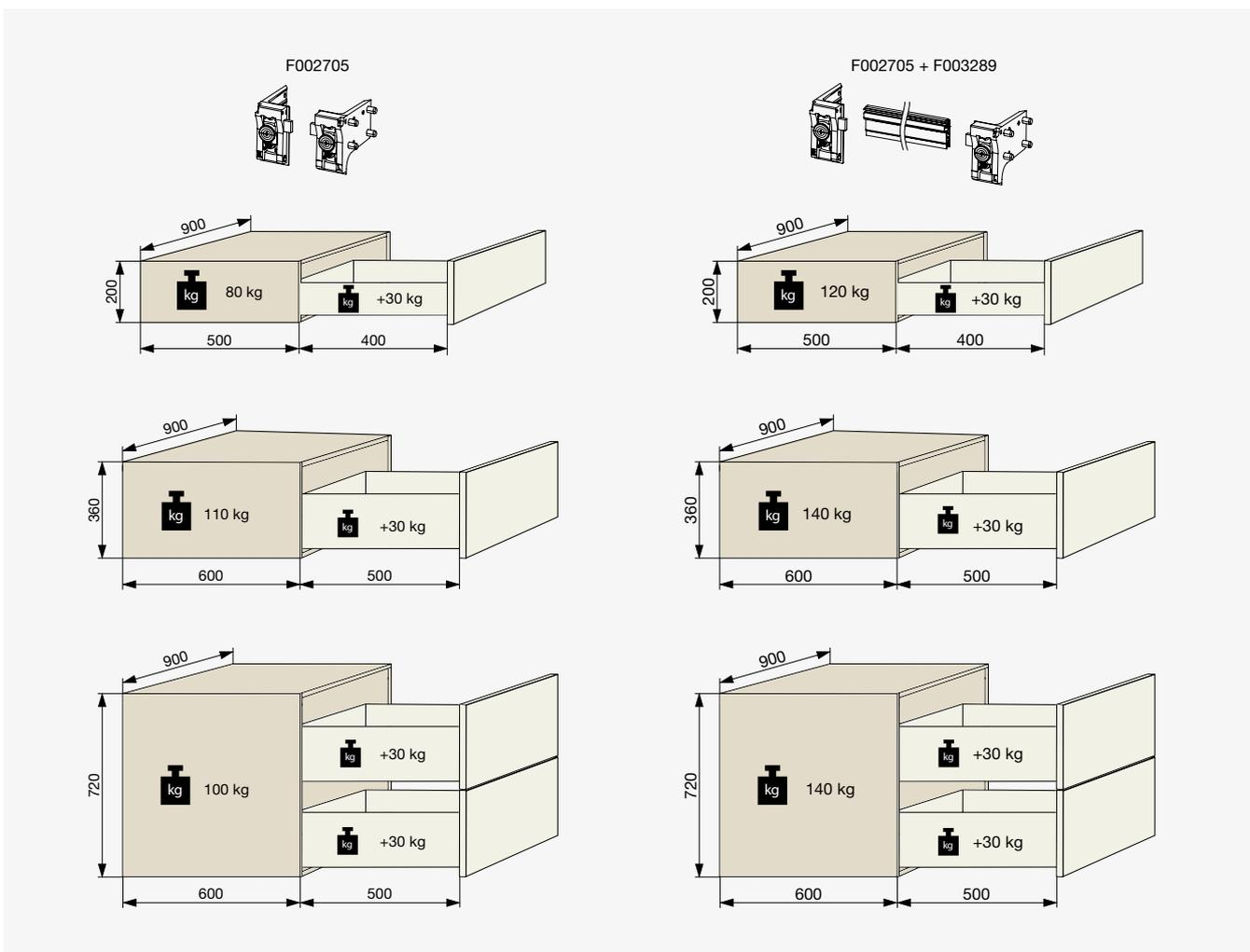

Ovo je primjer koji pokazuje razliku između korištenja modela sa i bez F003289 aluminijske šipke. Nosivosti se dobivaju empirijski i odnose se na konačnu konstrukciju ormara i korištene zidne spojeve.

## ● IF Skala H7 Aluminijska vješalica za ormarić

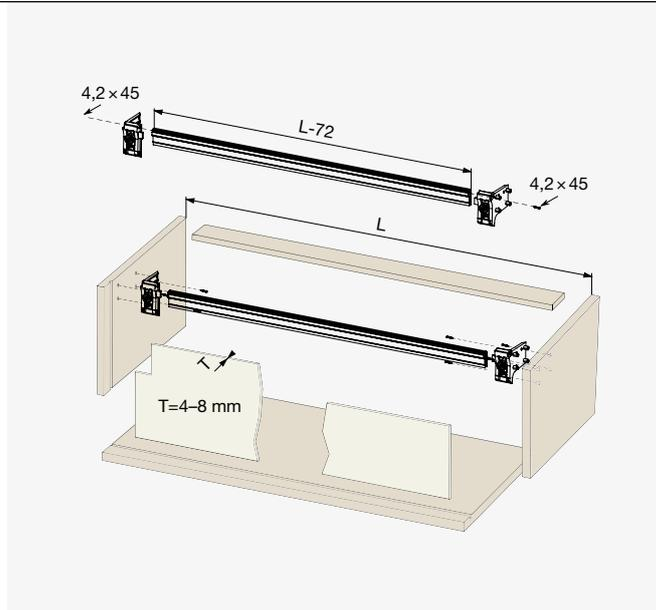
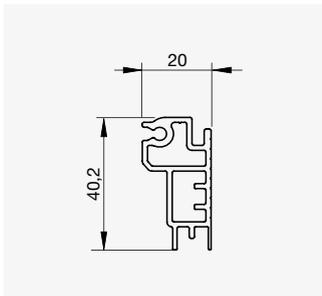

- Korištenje šipke omogućuje dodatne spojne točke na zid
- Nosivost možete povećati pomoću štapa
- Uglavnom se preporučuje za ormare s ladicama

Duljina [mm]	Kod	Visina [mm]
2000	F003289	40,2

## ● IF Skala H7 Navlake za garderobne vješalice

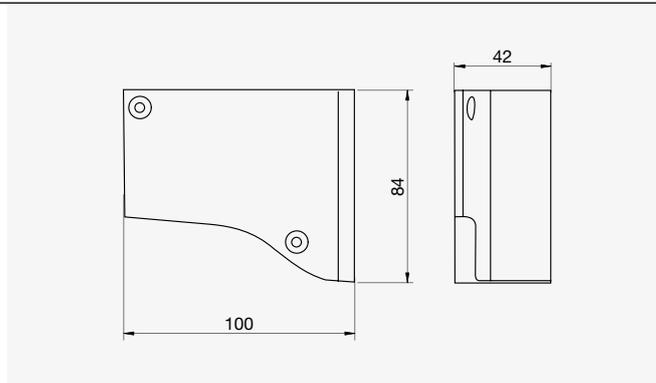

⊙ Bijela



⊙ Siva

Boja	Strana	Kod
Bijela	Desno	F003295
	Lijeva strana	F003296
Siva	Desno	F003297
	Lijeva strana	F003298

01  
02  
03  
04  
05  
06  
07  
08  
09  
10  
11  
12  
13  
14  
15  
16  
17  
18

## ● IF Libra H2 Vješalica za ormare

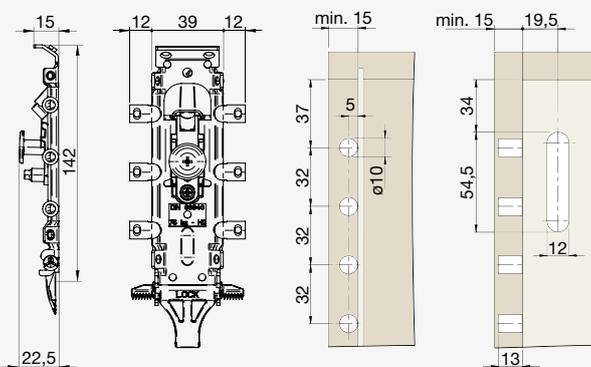
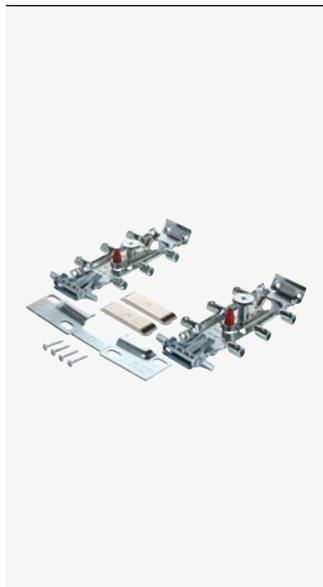

Libra H2 je verzija bez ručnog upravljanja s 3 zupca + zakretnicom za pričvršćivanje na stražnju ploču. Nosivost 75 kg po komadu [150 kg po paru].

**Podešavanje:**

- Okomito podešavanje: 13 mm
- Horizontalno podešavanje: 12 mm
- Sustav zaključavanja



Modela

Kod

Sa iglama

F003212

## ● IF Skala H2 Navlake za garderobne vješalice

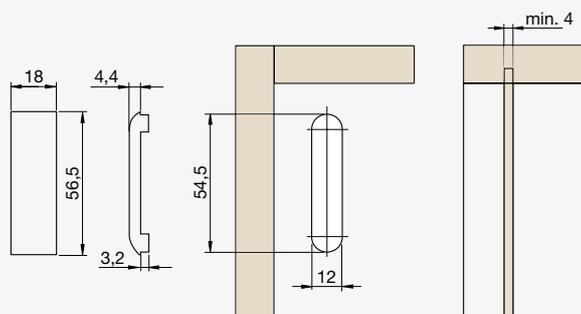

○ Bijela



● Siva



● Poniklano

Boja

Kod

Bijela

F003292

Siva

F003293

Poniklano

F003294

## ● IF Libra H11 Vješalica za ormare



Pogodan za vješanje postolja za sve vrste namještaja. Brza i jednostavna montaža s 4 prethodno izbušene rupe na bočnoj ploči. Sigurnosna brava protiv izbacivanja.

**Podešavanje:**

- Okomito  $\pm 6$  mm
- Dubina  $\pm 5$  mm

**Paket sadrži:**

- 1 kom Libra H11 desno
- 1 kom. pločice WP13
- 1 komad WP13 ploče
- 8 komada matica za umetanje
- 16 komada vijaka
- List s uputama

- Nosivost 125 kg / set – ovisno o dimenzijama ormara i načinu spajanja na zid

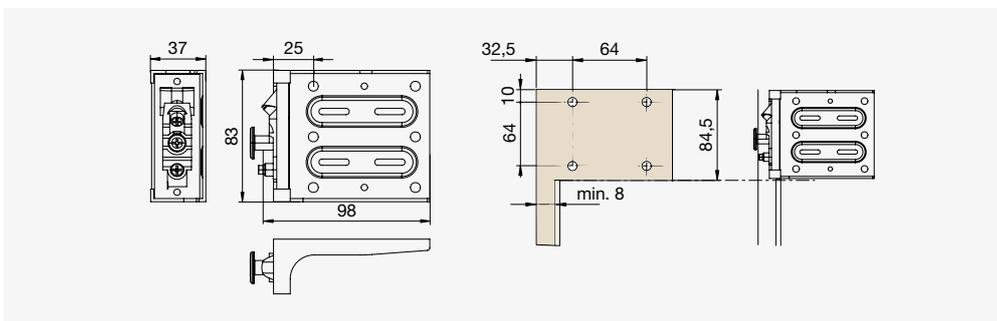

Model

Kod

Mjerilo H11

F004666

## ● IF Skala H11 Navlake za garderobne vješalice

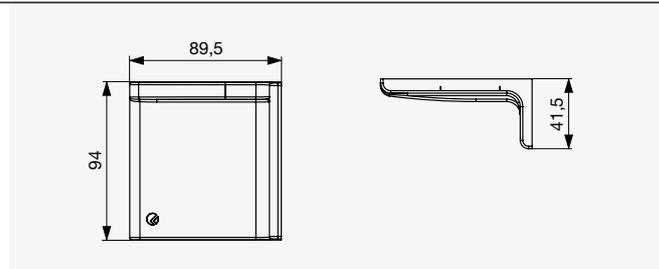

● Siva



○ Bijela

Boja	Strana	Kod
Bijela	Desno	F005511
	Lijeva strana	F005512
Siva	Desno	F005513
	Lijeva strana	F005514

## ● AKO APC 1

## Vješalica za ormarić sa zidnom pločom WPC2

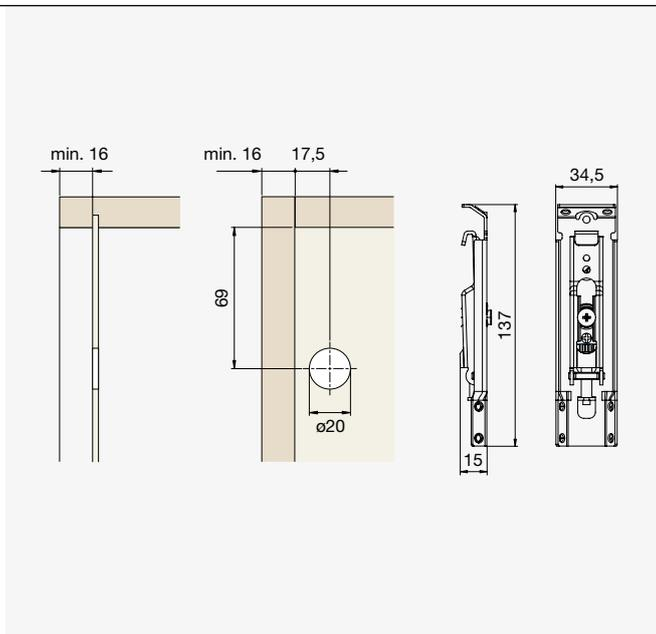

- APC1 je dvokraki nevidljivi vijak za pričvršćivanje kućišta
- Omogućuje jednostavnu montažu bez prethodnog bušenja
- Za pristup svim postavkama potrebna je samo jedna rupa
- Nosivost 60 kg po komadu

**Podешavanje:**

- Okomito  $\pm 9$  mm
- Dubina  $\pm 15,5$  mm

**Prednosti:**

- Širok raspon postavki
- Nema prethodnog bušenja
- Jedna kapa



Model

Kod

Nosivost  
[kg]

APC 1

F002706

60 po komadu

## ● IF APC 6

## Vješalica za ormar

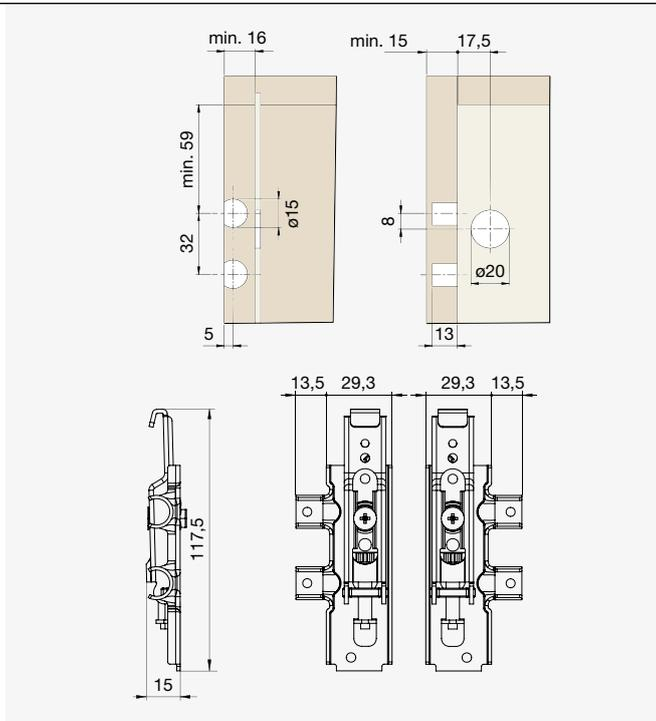

- Širok raspon prilagodbi – okomita i dubinska prilagodba
- Za pristup svim postavkama potrebna je samo jedna rupica
- Nosivost 60 kg po komadu na temelju internih ispitivanja

**Podешavanje:**

- Okomito  $\pm 9$  mm
- Dubina  $\pm 15,5$  mm

**Paket sadrži:**

- 1 kom APC6 desno
- 1 kom APC6 lijevo
- 2 komada WPC2 zidne ploče
- 2 komada poklopaca  $\phi 20$  bijele boje
- 4 komada Panelvit vijka
- 1 komad lista s uputama



Tip

Kod

Nosivost  
[kg]

APC 6

F004665

60

● IF Okrugla vješalica za ormar

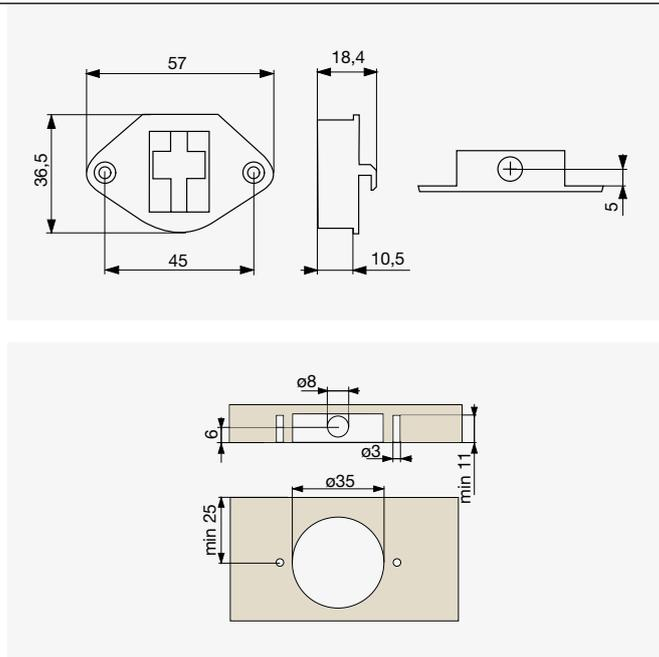

- Podešavanje: okomito  $\pm 9,5$  mm
- Koristite s bilo kojom vrstom zidne ploče

- Kapacitet opterećenja:**
- do 80 kg / par za stolom
  - do 50 kg / par za ormarić [600 x 600 x 250 mm]

Boja

Kod

Crna

F002707

● IF ZK Vješalica za ormar



Ⓢ Desno

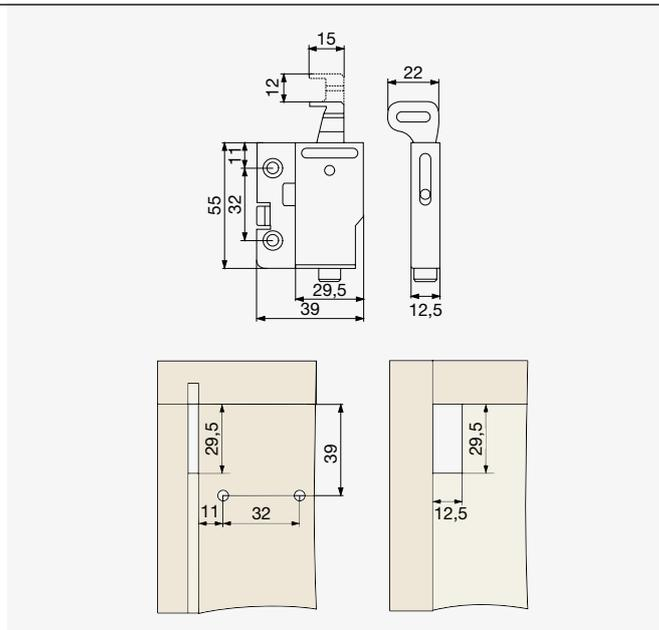

- Podešavanje:**
- Okomito  $\pm 8$  mm
  - Dubina  $\pm 8$  mm



Ⓢ Lijevo

Strana

Kod

Desna

F003324

Lijeva

F003325

01  
02  
03  
04  
05  
06  
07  
08  
09  
10  
11  
12  
13  
14  
15  
16  
17  
18

## ● IF ZK Navlake za vješalice za ormare



ⓐ Lijevo



ⓑ Desno

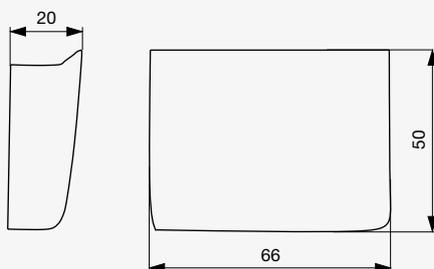

Boji	Strana	Kod
Bijela	Right	F003326
	Left	F003327
Siva	Right	F003328
	Left	F003329

## ● IF Zidna ploča

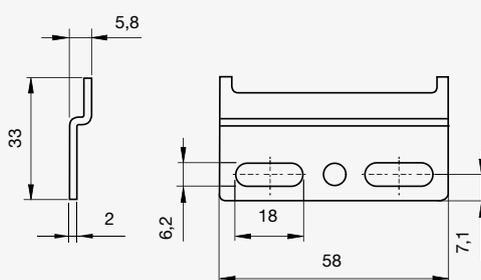

Duljina [mm]	Kod	Debljine [mm]
58	F002708	2



● IF Zidni panel

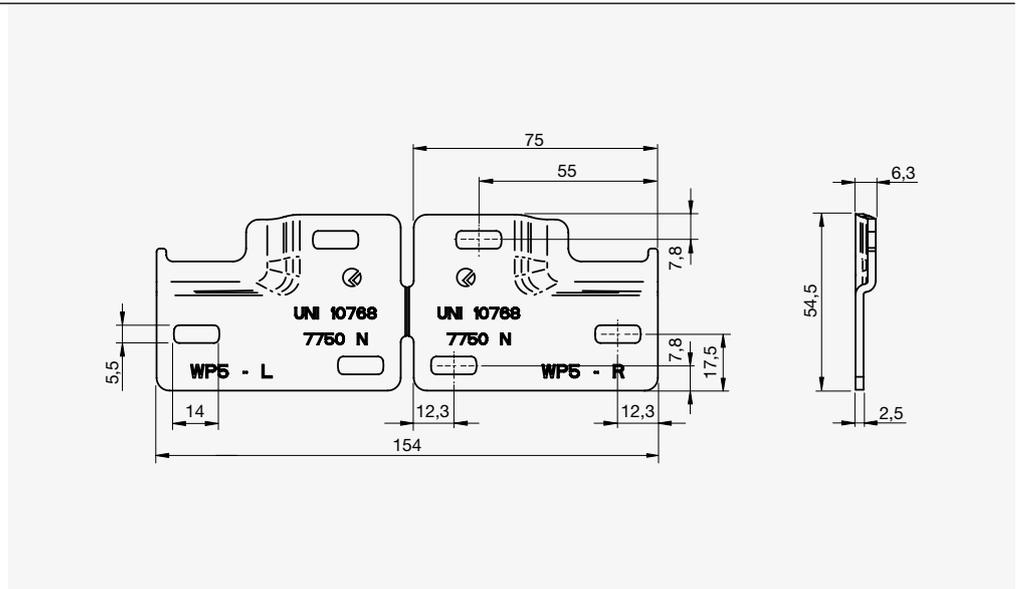

- Paket uključuje lijevu i desnu ploču

Duljina [mm]	Kod	Debljine [mm]
75	F003291	2,5

● IF Zidna šipka Libra B3

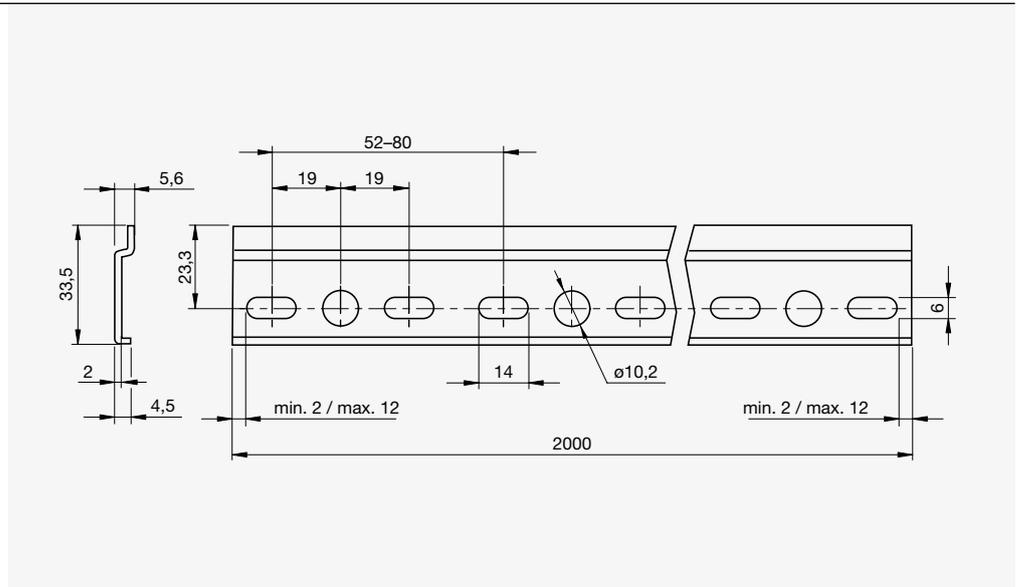

Duljina [mm]	Kod	Debljine [mm]
2000	F003290	2

01  
02  
03  
04  
05  
06  
07  
08  
09  
10  
11  
12  
13  
14  
15  
16  
17  
18

● IF SH1 in SH7 Nosač za zaštitu



SH je sustav protiv prevrtanja za samostojeće skladišne jedinice sa ili bez stražnje ploče, kao što su komode, komode, ormari u spavaćim sobama, dnevnim sobama i kupaoinicama.

- SH1 – za elemente sa stražnjom stranom
- SH7 – za elemente bez stražnje ploče

Model	Kod
SH1	F004668
SH7	F004669

Ⓢ SH1

Ⓢ SH7

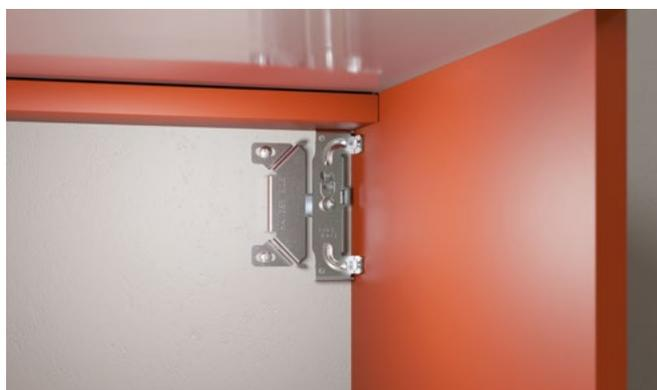
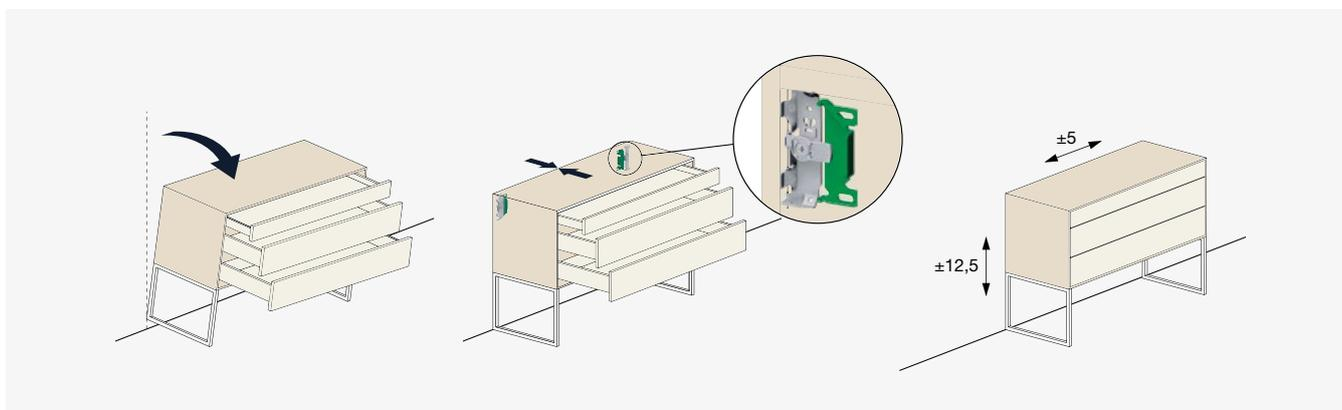

● IF SH zidna ploča

14

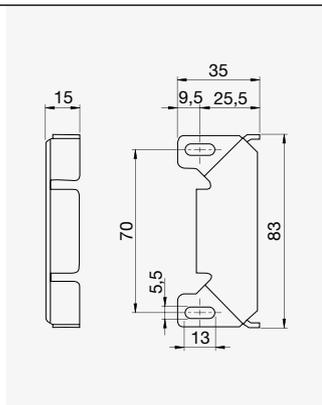

- Za kombinaciju s nosačima SH1 ili SH7

Vrsta	Kod
Zidna ploča	F004670

# Nosač za police

## ⊕ Riex JC60 Nosač za police



● Poniklano

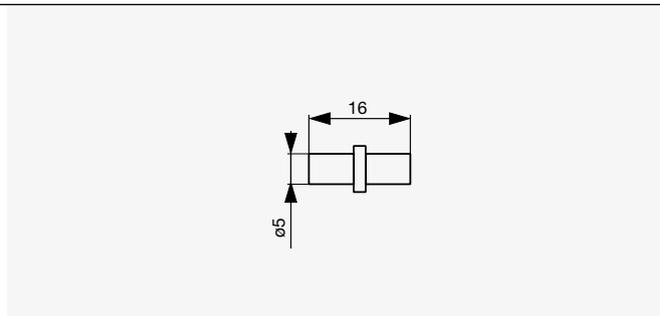

Dimenzija D2 / D1 [mm]	Kod	Boja
5/5	F002008	Poniklano
	F002009	Bijeli cink

## ⊕ Riex JC60 Nosač za police



● Poniklano

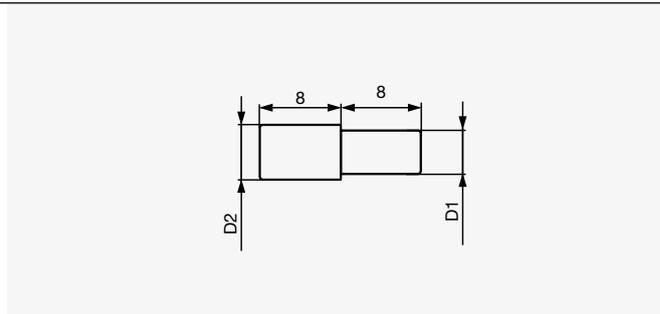

Mjera D2 / D1 [mm]	Kod	Boja
3/3	F004506	Poniklano
5/3	F002007	

**⊕ Riex JC62**  
**Kućište za TOP priključnu policu za 18 mm**

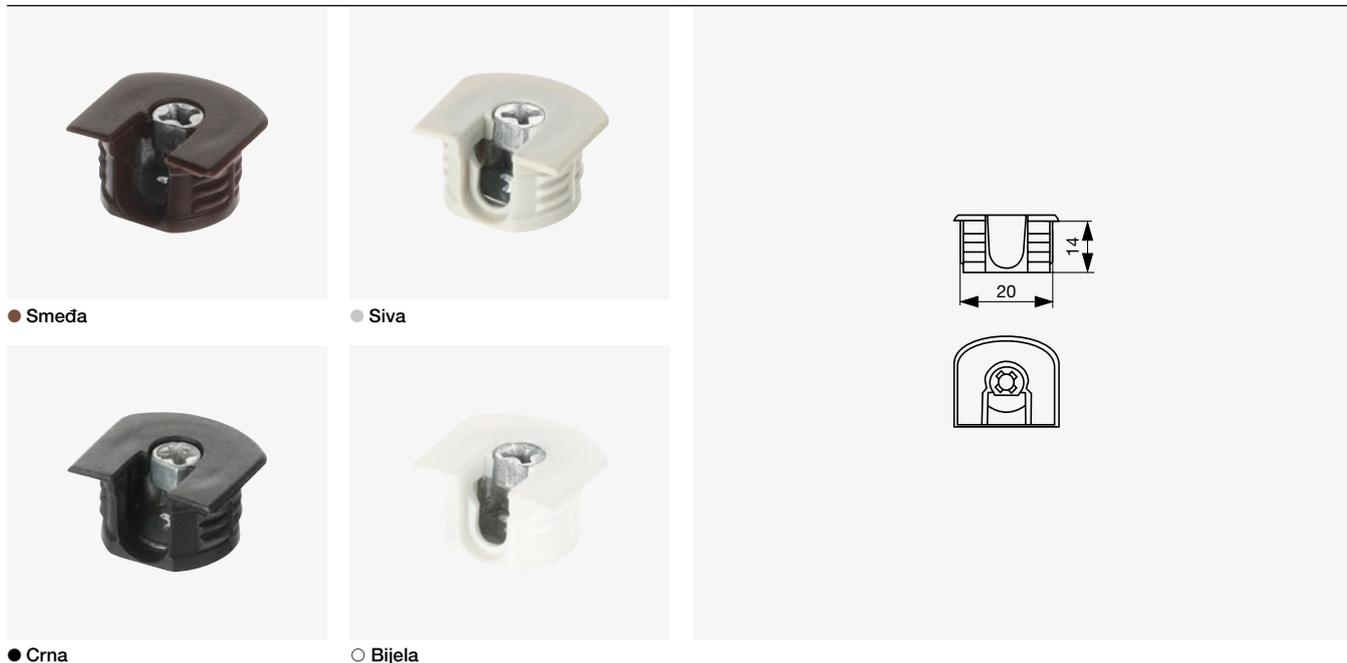

Boja	Kod	Promjer [mm]	Višina [mm]
● Smeđa	F002537	20	14
● Siva	F002538		
● Crna	F002539		
○ Bijela	F002540		

**⊕ Riex JC62**  
**Kućište terminalne police TOP Double za 18 mm**

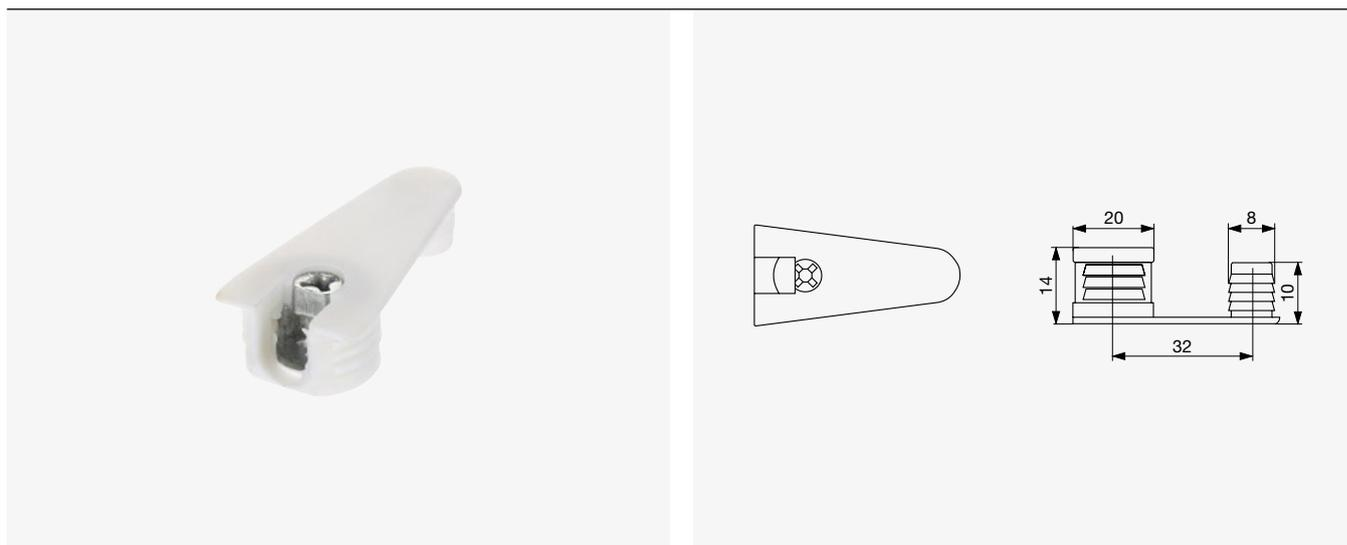

Boja	Kod	Promjer [mm]	Visina [mm]
○ Bijela	F002543	20 / 8	14 / 10

14

## ⊕ Riex JC62

### Kućišta police konektora JC62



⊙ F002544



⊙ F002545

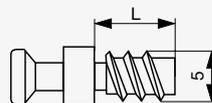

Duljina L [mm]	Kod	Promjer [mm]	Boja
11	F002544	5	Bijeli cink
7,5	F002545		

## ⊕ Kućište police za Riex JC55 konektor

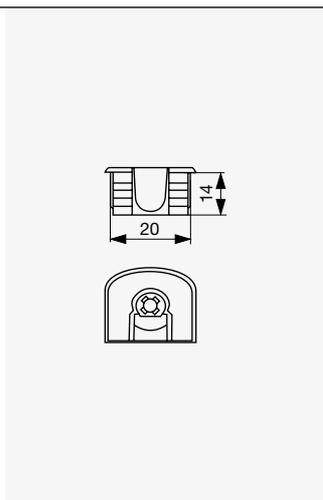

Debljina ploče [mm]	Materijal	Kod
18-20	Cink	F003080

## ⊕ Riex JC55

### konektor za dvostruku policu

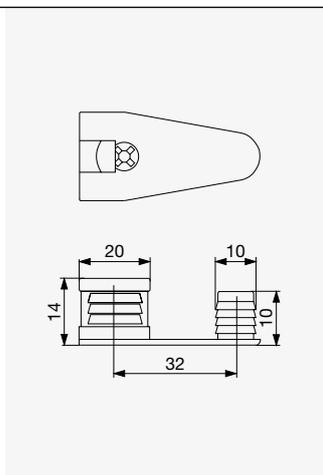

- Za potpunu upotrebu JC55 vijka F003082

Debljina ploče [mm]	Materijal	Kod
18-20	Zinc	F003081

### ⊕ Eurovijak Riex JC55 za police

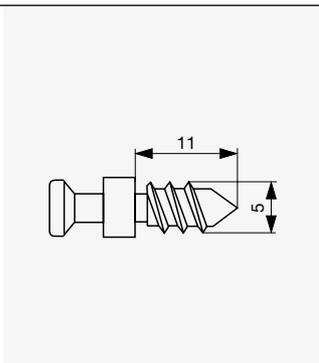

Veza	Kod	Duljina [mm]
Euroscrew	F003082	11

### ⊕ Nosač police Riex JC78

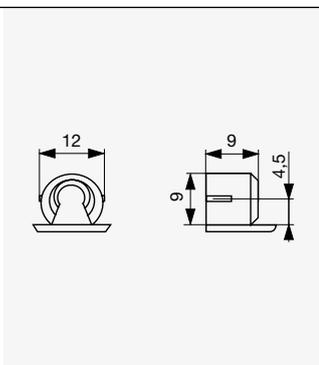

- Kompletan set s iglom za police 5/5

Boja	Kod
Bijela	F002550

### ⊕ Nosač polica Riex JC71

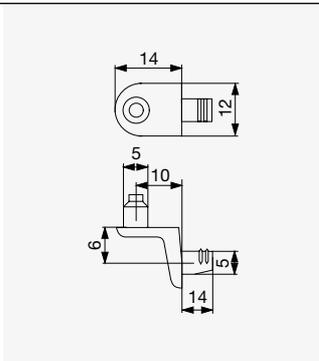

Boja	Kod
Poniklano	F002546

### 14 ⊕ Riex JC72 Nosač police za eurovijak

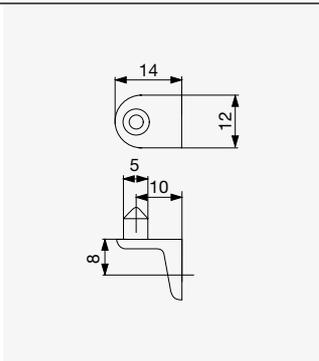

Boja	Kod
Poniklano	F002547

### ⊕ Riex JC73 Nosaić polica

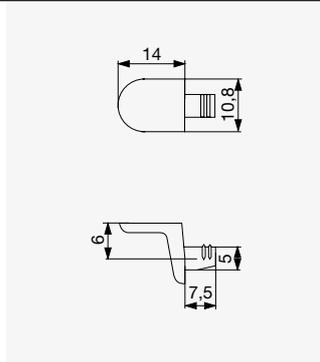

Boja

Kod

Poniklano

F002548

### ⊕ Riex JC74 Plastični nosaić polica

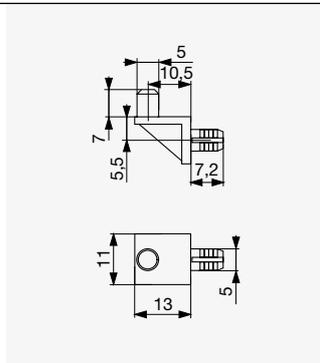

Boja

Kod

Bijela

F002549

### ⊕ Nosaić staklene police Riex JC79

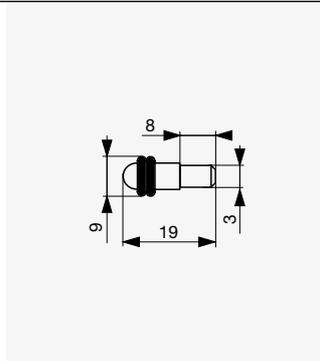

Promjer

Kod

3/5

F002551

### ⊕ Nosaić staklene police Riex JC61

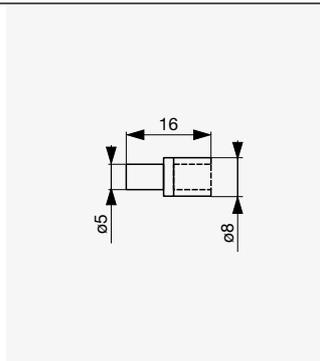

Promjer

Kod

5

F004507

### ● Riex JC42 Nosač za staklene police

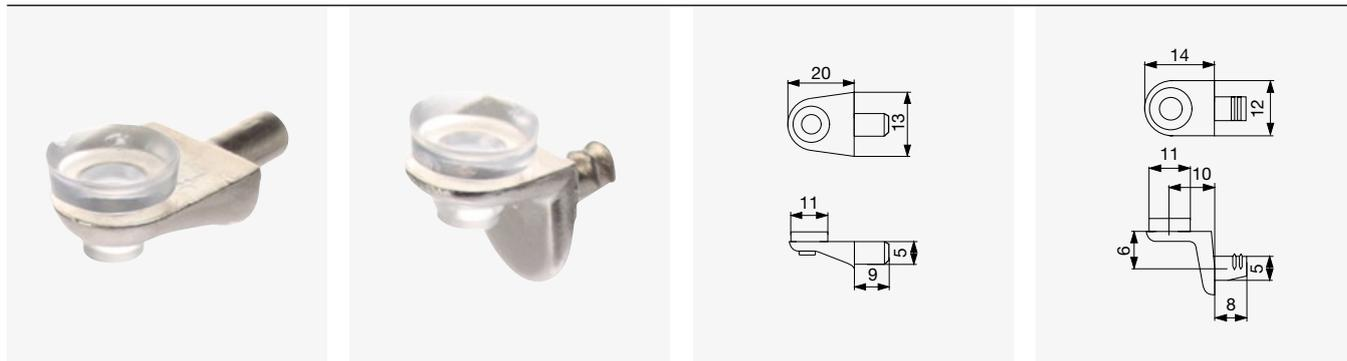

① F002552

① F002553

① F002552

① F002553

Tip	Kod
Bez rebara	F002552
S rebrima	F002553

### ● IF K-Line nosač police s klinom

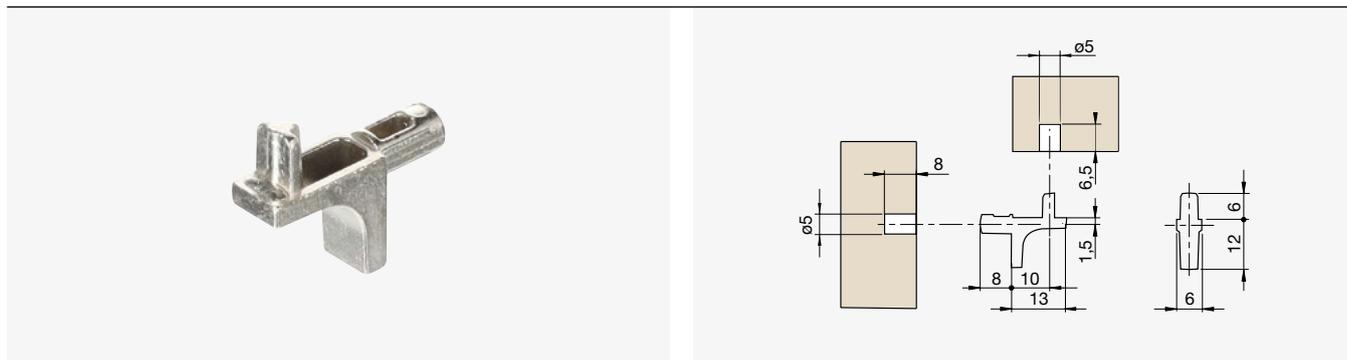

Boja

Kod

Nikal	F002693
-------	---------

### ● IF Nosač za K-Line police



● Crni nikal

● Nikal

Boja

Kod

Crni nikal	F002694
Nikal	F002695



● IF K-Line Nosač za staklene police

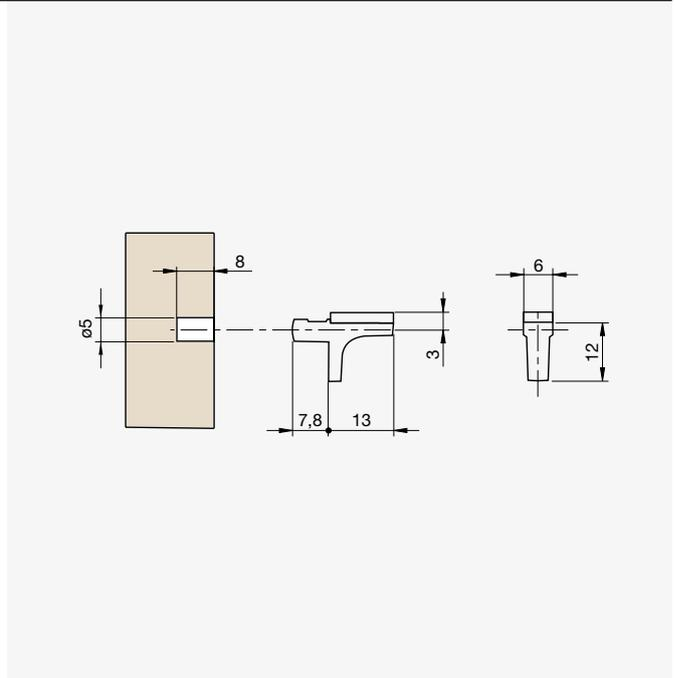

Boja

Kod

Nikal

F002696

● IF Nosač za policu na izvlačenje



- Zatezni nosač
- Može se koristiti s eurovijkom ili Spax nikl vijcima [F004280]
- Visoke performanse

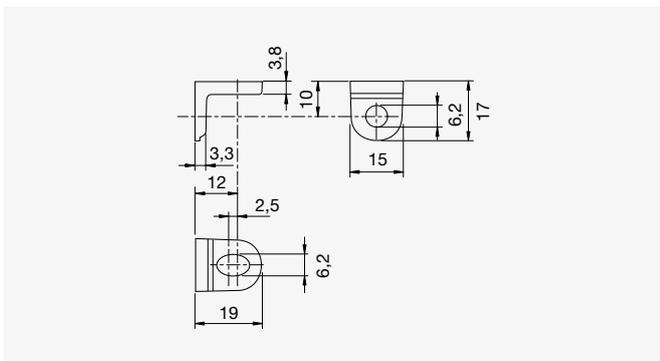

Boja

Kod

Nikal

F002697

01  
02  
03  
04  
05  
06  
07  
08  
09  
10  
11  
12  
13  
14  
15  
16  
17  
18

### Držač staklene police Riex

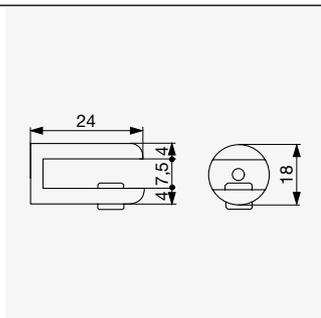

Boja	Kod	Promjer [mm]	Debljina stakla [mm]
Srebro	F002554	20	max 7,5

### Riex JC44 Kockasti nosivi nosač za staklene police



Tip	Boja	Kod
Za vijak	Nikal	F003064
	Crni niki	F003065
Sa klinom	Nikal	F003066
	Crni niki	F003067

• Za debljinu stakla od 5–6 mm

F003064

F003067

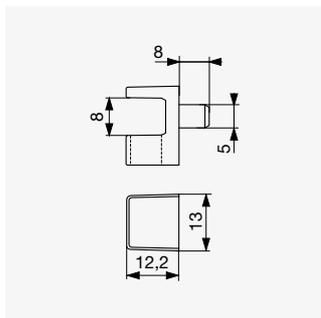
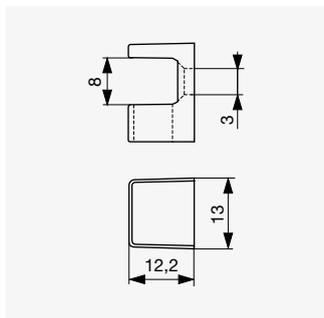

F003064

F003067

### IF nosač Kristalno staklo



14

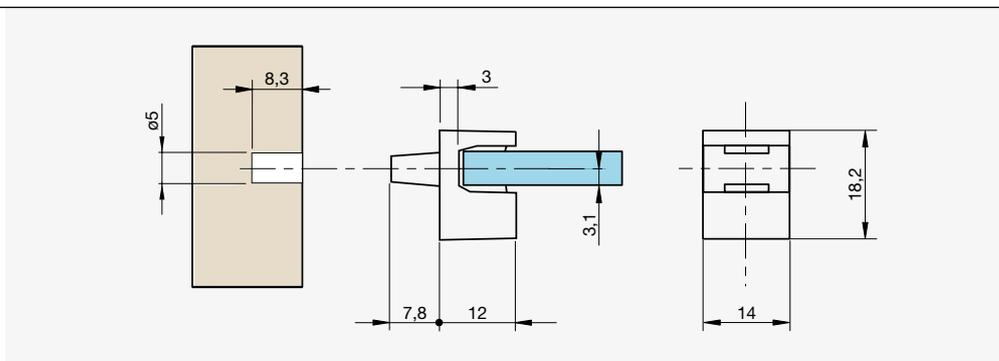

Boja	Kod	Promjer klina [mm]	Debljina stakla [mm]
Krom	F002692	5	5–6

## ⊕ Riex JC45 Nosач za staklene police

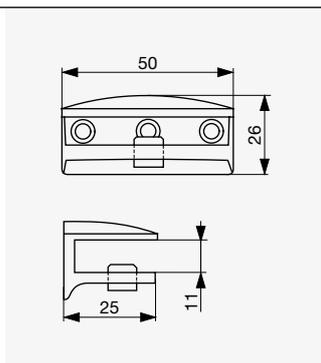

Boja	Kod	Debljina ploče [mm]
Krom	F003068	Max. 11

## ⊕ Nosач zidne police Riex JC48

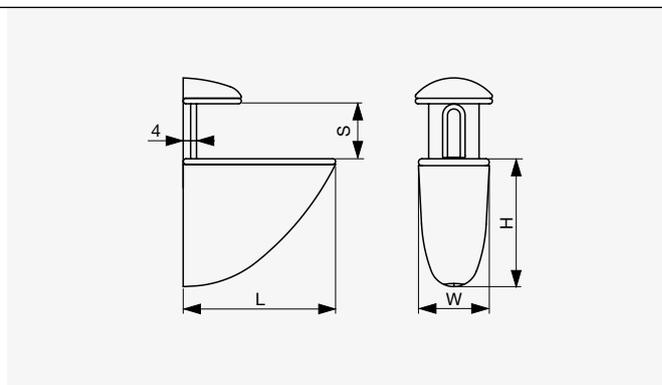

● Krom

Boja	L [mm]	Kod	Maksimalna debljina ploče S [mm]	H [mm]	W [mm]	Nosivost [kg]
Krom	40	F003070	20	40	25	20
	70	F003072	20	48	25	30
	105	F003074	40	70	38	40

## ⊕ Nosач zidne police Riex JC49

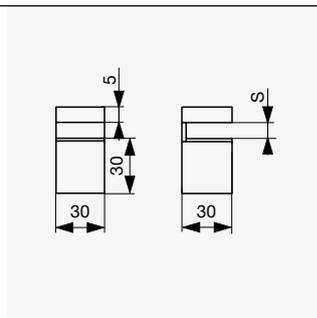

⊕ F003078

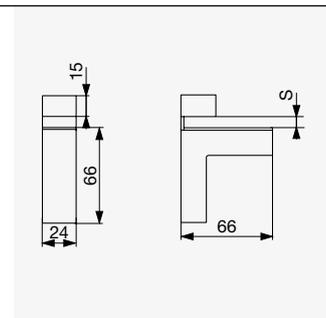

⊕ F003077

Boja	Duljina [mm]	Kod	Najveća debljina ploče S [mm]	Nosivost [kg]
Krom	30	F003078	16	20
	66	F003077	40	40

# Nosači za police

## ● Citterio Giulio JK59 Nosač polica



● Mat zlatna



● Francuska patinirana bronca  
● Mat crna  
● Mat srebro

- Ručke istog dizajna na str. 4.11

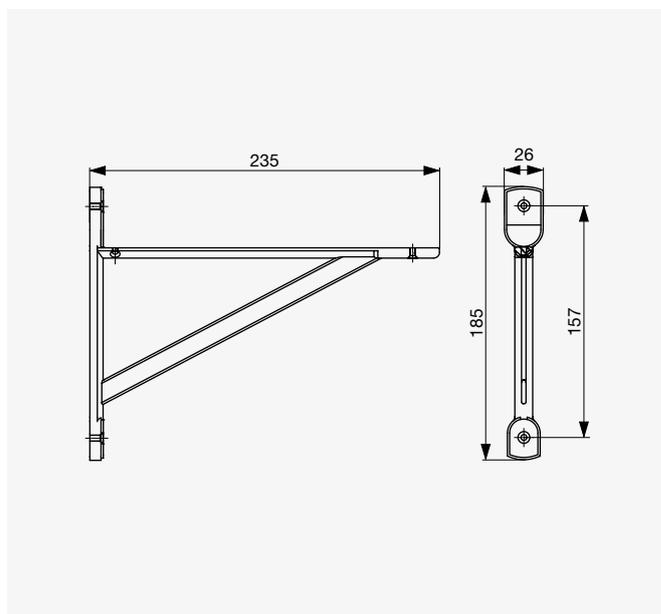

Boja	Kod
Francuska patinirana bronca	F004512
Mat crna	F004510
Mat zlato	F004511
Mat srebro	F004513

● IF Luna S Nosač za policu



● Krom

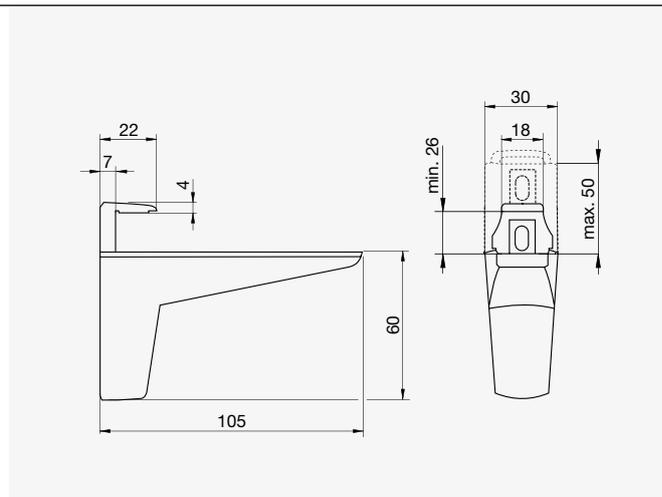

⊙ F002711, F002712



● Sivi metal

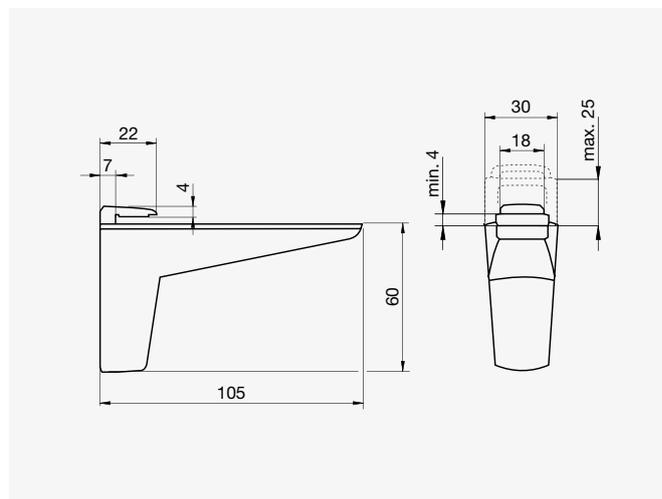

⊙ F002709, F002710

Debljina ploče [mm]	Boja	Kod
15-50	Krom	F002712
	Metalik siva	F002711
4-25	Krom	F002710
	Metalik siva	F002709

● IF Kalabrone Mini nosač polica

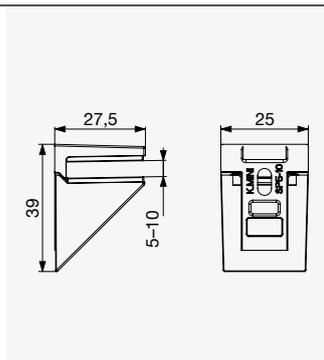

Boja	Kod	Debljina ploče [mm]
Nehrđajući čelik	F002714	5-10

01  
02  
03  
04  
05  
06  
07  
08  
09  
10  
11  
12  
13  
14  
15  
16  
17  
18

● IF Triade skriveni nosač polica



① Standardno

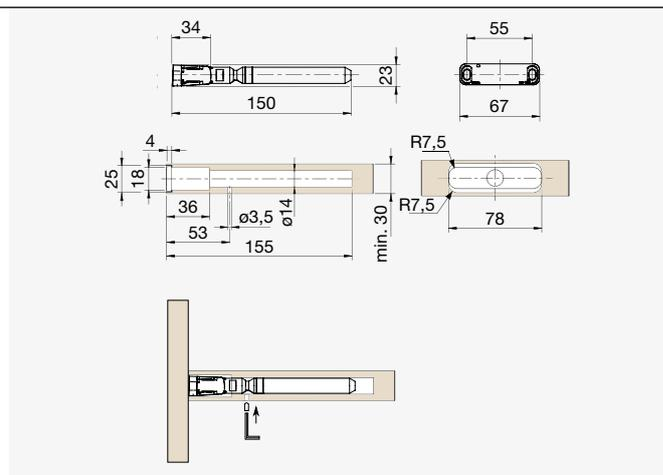

① F002717

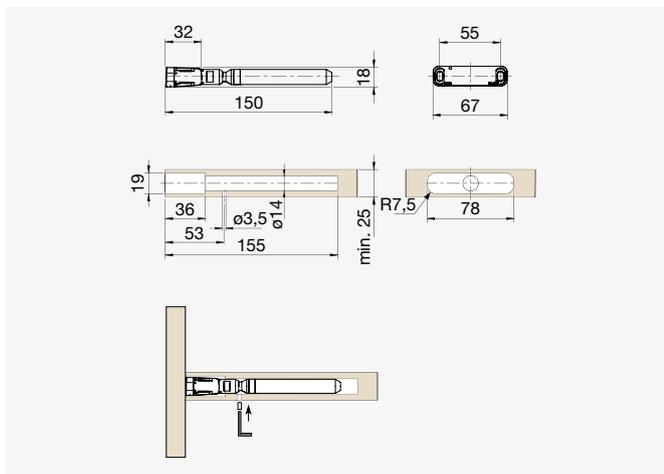

① F002715

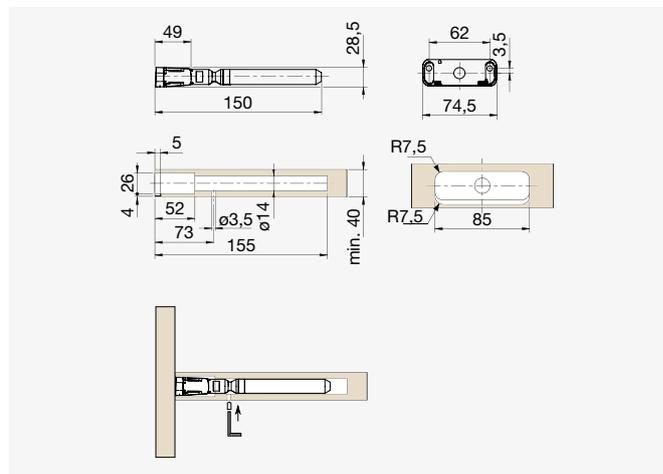

① F002719

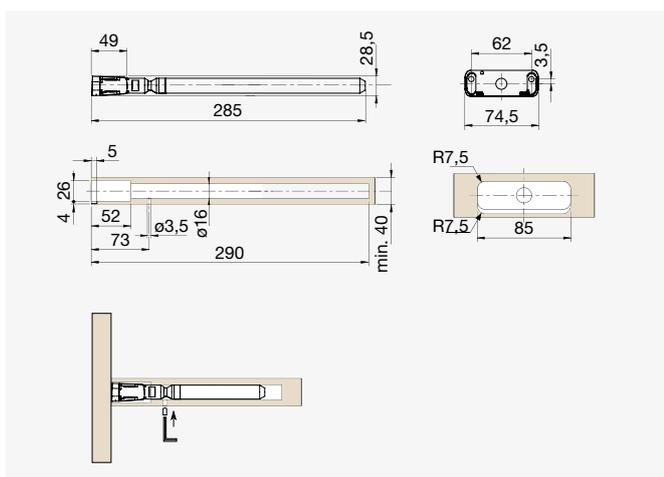

① F002721

• 3D podešavanje [strana, gore / dolje, nagib]

14

Tip	Kod	Min. debljina ploče
Mini	F002715	25
Standard	F002717	30
Maxi	F002719	40
XXL	F002721	

● IF Triade skriveni nosač police



① Standardno

- Povećanje kapaciteta konzole police Triad
- Crteži su kompletni setovi Triade nosača i Triade konzole za police

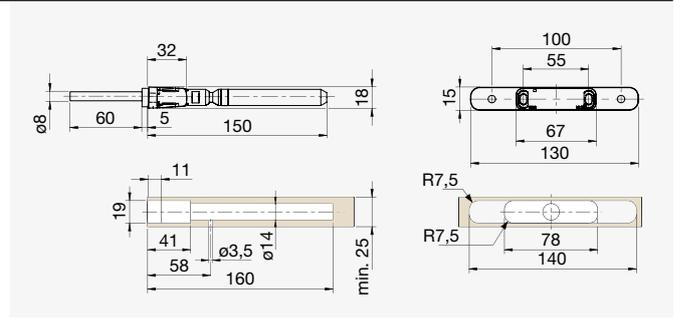

① F002716

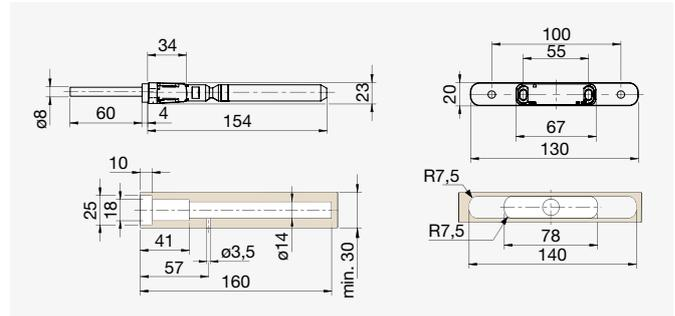

① F002718

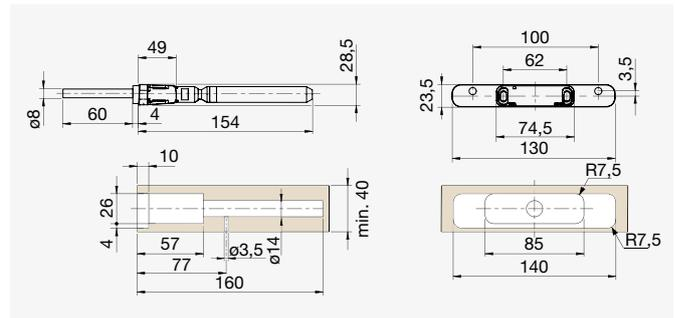

① F002720

Tip	Kod
Mini	F002716
Standard	F002718
Maxi / XXL	F002720

● Riex JK31 skriveni nosač polica

RiEx



Duljina [mm]	Kod	Promjer [mm]
110	F002864	8
150	F002863	11

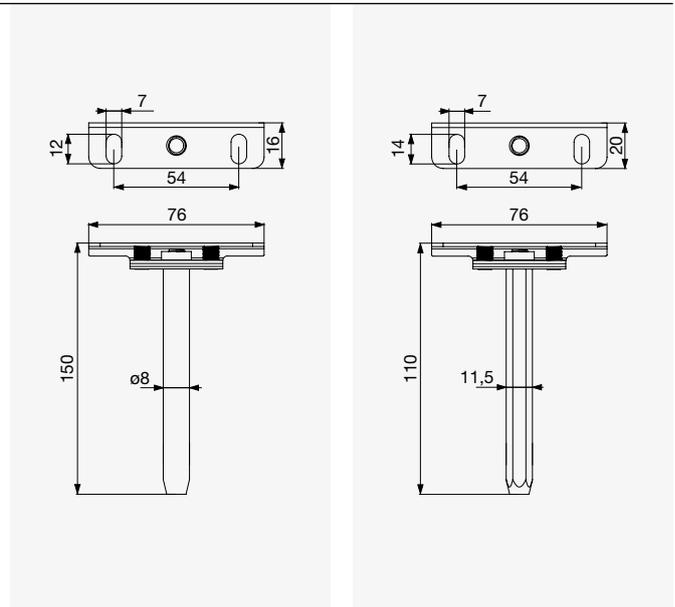

01  
02  
03  
04  
05  
06  
07  
08  
09  
10  
11  
12  
13  
14  
15  
16  
17  
18

### ⊕ Potpora za police Riex JK25

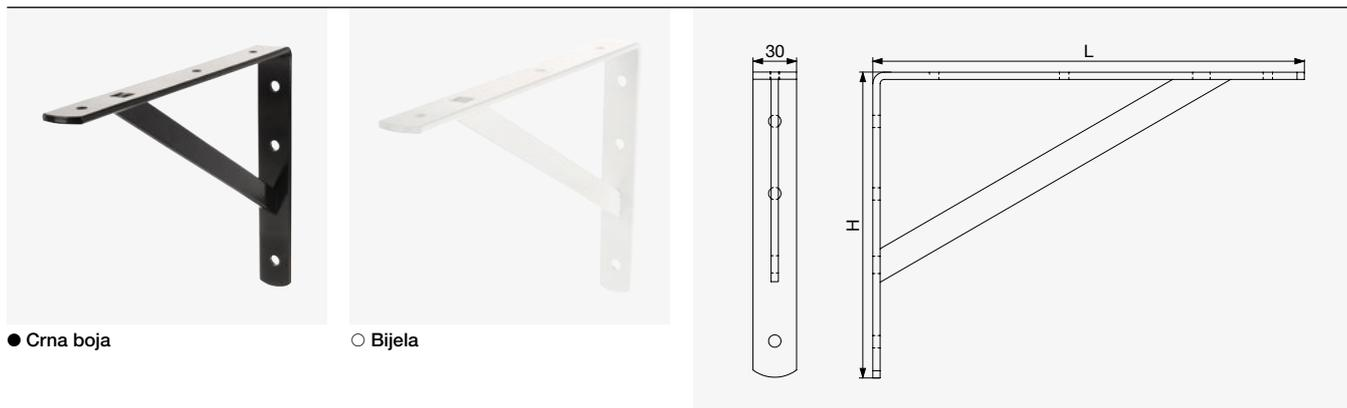

● Crna boja

○ Bijela

Dimenzije L × H [mm]	Boja	Kod
300 × 210	Crna	F004326
	Bijela	F004324
350 × 240	Crna	F004327
	Bijela	F004325

### ⊕ Riex JK28 Nosač polica s plastičnim poklopcem



● Smeđa

○ Bijela

Dimenzije L × H [mm]	Boja	Kod	Širina W [mm]
119 × 77,5	Brown	F002018	25
	Bijela	F002015	25
183 × 114	Brown	F002019	35
	Bijela	F002016	35
237 × 143	Brown	F002020	34
	Bijela	F002017	34

### ⊕ Stakleni konektor Riex JK30

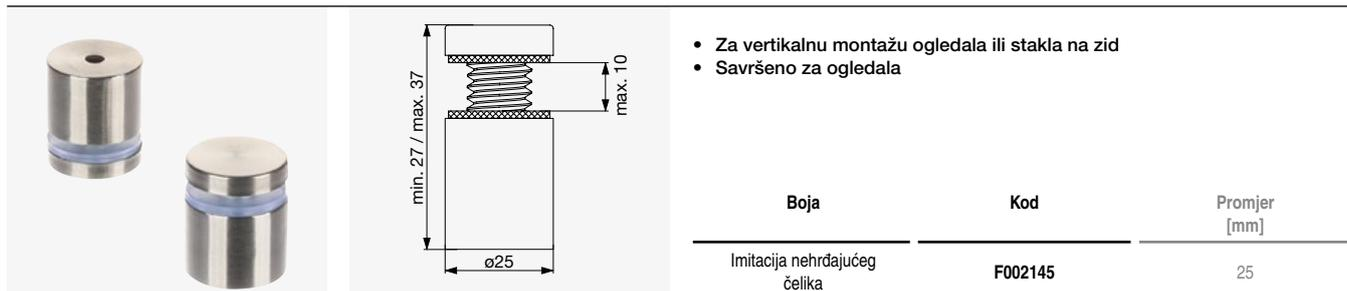

- Za vertikalnu montažu ogledala ili stakla na zid
- Savršeno za ogledala

Boja	Kod	Promjer [mm]
Imitacija nehrđajućeg čelika	F002145	25



# Kutni i priključni nosači

## ➊ Riex JP20 kutni nosač za ormarić mali



● Smeđa

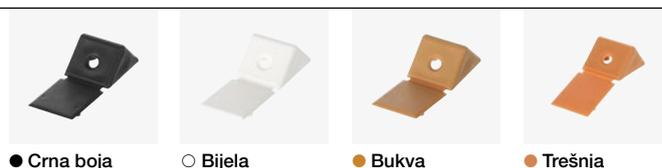

● Crna boja

○ Bijela

● Bukva

● Trešnja



● Drvo breze

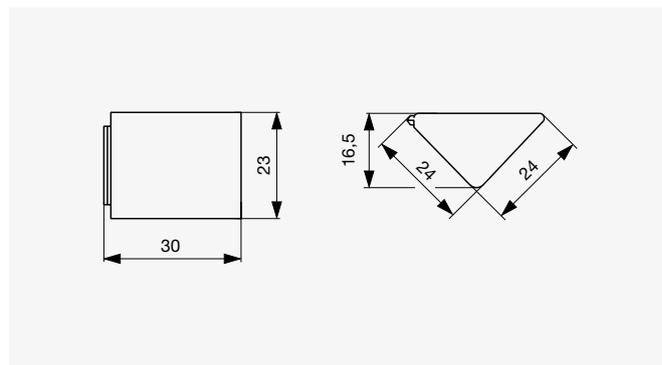

Boja	Kod
Smeđa	F002966
Crno	F002967
Bijela	F002968
Drvo bukve	F002969
Trešnja	F002970
Drvo breze	F002971

### ⊕ Riex JP30 Kutna spojnica za ormar

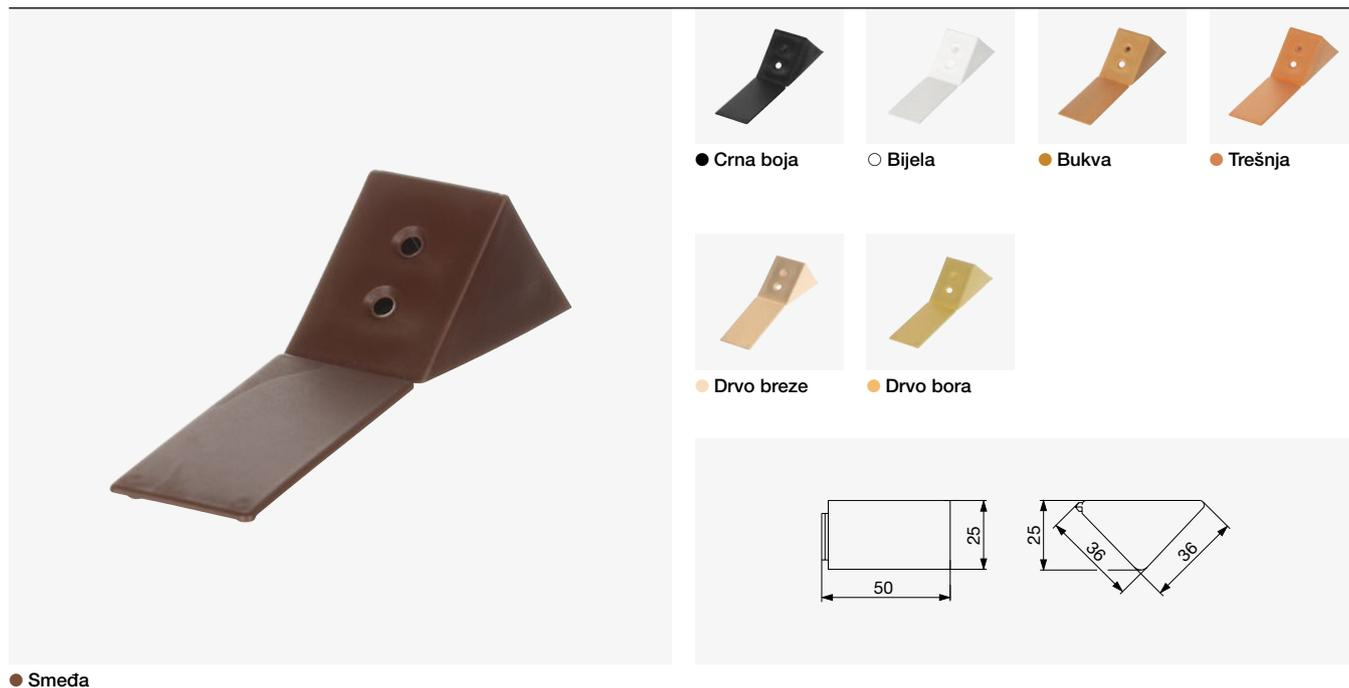

● Smeđa

Boja	Kod
Smeđa	F002972
Crno	F002973
Bijela	F002975
Drvo bukve	F002976
Trešnja	F002977
Drvo breze	F002978
Drvo bora	F002979

### ⊕ Riex JK08 Spojnica za ormar s klinom

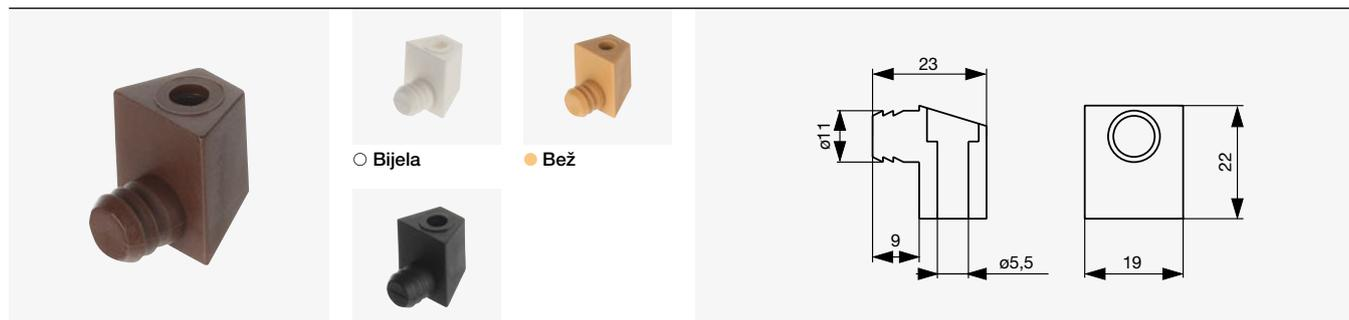

● Smeđa

● Crna

○ Bijela

● Bež

Boja	Kod
Smeđa	F002949
Bijela	F002950
Crna	F002951
Bež	F002952

## ● IF Donji priključak ladice

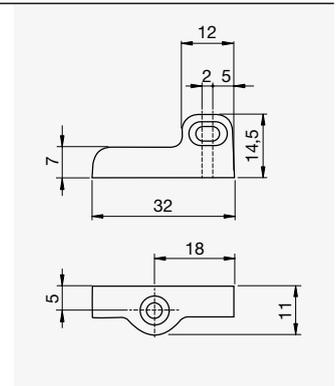
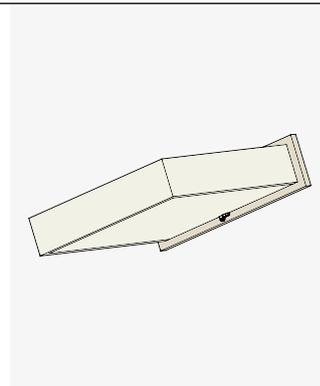
ITALIANA  
SERRAMENTI

Boja

Kod

Bijela

F003085

## ⊕ Kutni metalni nosač Riex JC41

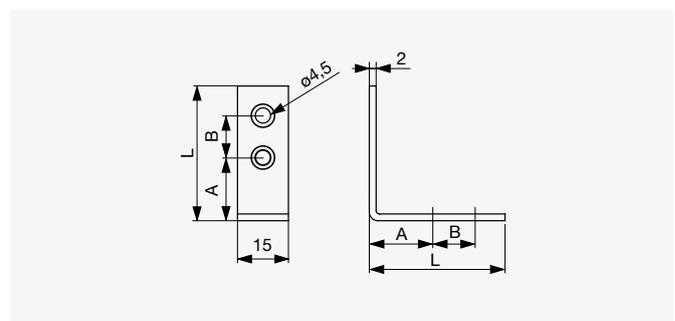
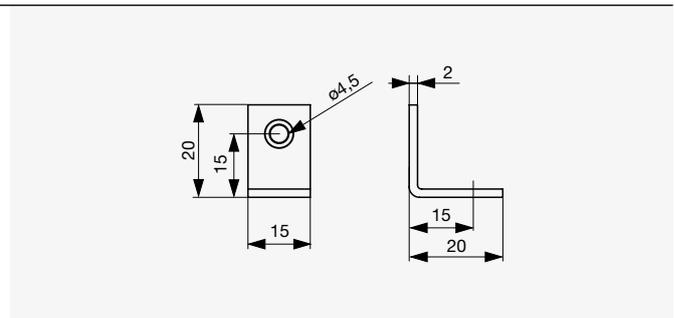

Duljina L [mm]	Kod	A [mm]	B [mm]
20	F003101	×	×
25	F003102	8,5	9,5
30	F003103	9,5	12,5
40	F003104	17	17
50	F003105	17,5	24
60	F003106	18	34
70	F003107	18	44
80	F003108	29,5	42,5
90	F003109	29,5	52,5
100	F003110	29,5	62,5

## ⊕ Riex JC47 Kutni metalni nosač

- Debljina 2 mm
- Boja bijela cink

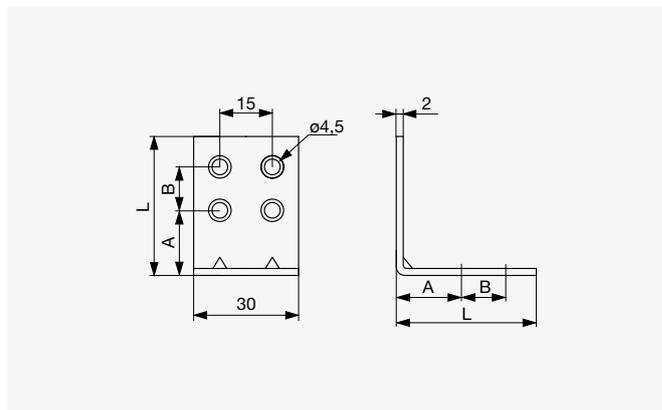

Dimenzija L x L [mm]	Kod	A [mm]	B [mm]
40 x 40	F003118	16,5	16,5
50 x 50	F003119	16,5	27
60 x 60	F003120	16,5	37

## ⊕ Riex JC43 Ravna metalna ploča

- Debljina 2 mm
- Boja bijela cink

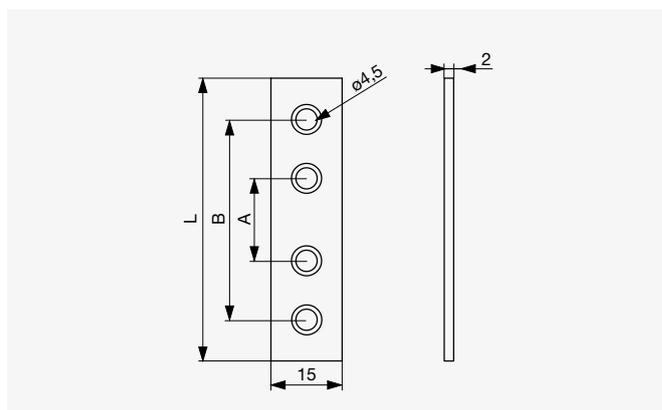

Duljina L [mm]	Kod	A [mm]	B [mm]
60	F003112	17,5	43
80	F003113	29	63
100	F003114	35	83
120	F003115	35	103
140	F003116	35	123

## ⊕ Riex JC46 Ravni metalni nosač



- Debljina 2 mm
- Boja bijela cink

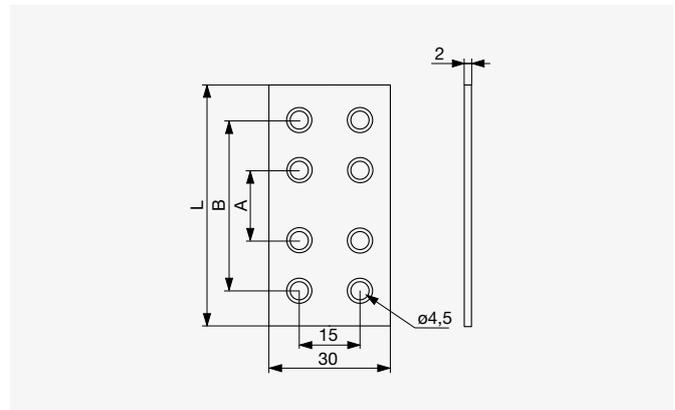

Duljina L [mm]	Kod	A [mm]	B [mm]
60	F004321	17,5	43
80	F004322	29	62
100	F003121	29	83,5

## ⊕ Riex JC45 ravna kutna metalna ploča



- Debljina 2 mm
- Boja bijela cink

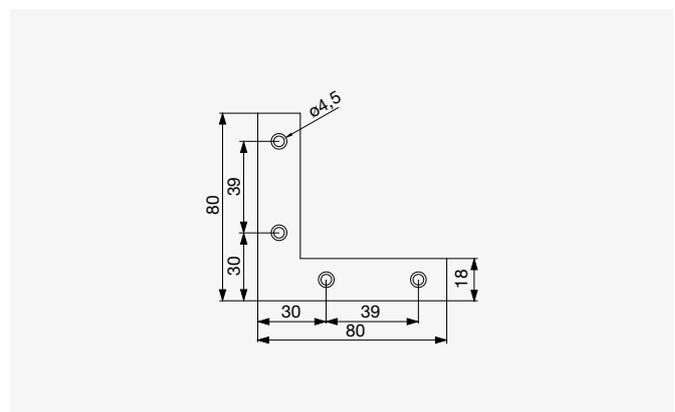

Mjera L [mm]	Kod
80 × 80	F003122

### ⊕ Riex JC51 kutna metalna ploča

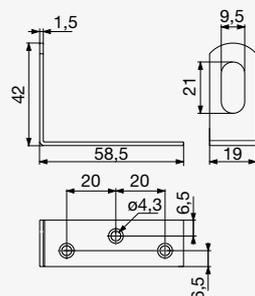

- Debljina 1,5 mm
- Boja bijeli cink

Mjera [mm]	Kod
58,5 x 42	F004314

### ⊕ Kutna metalna ploča Riex JC52

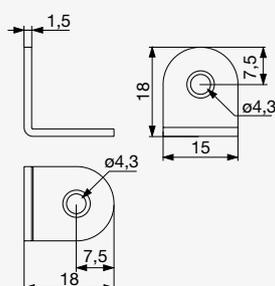

- Debljina 1,5 mm
- Boja bijela cink

Mjera [mm]	Kod
18 x 18	F004315

### ⊕ Kutni metalni nosač Riex JC42 s ovalnom rupom

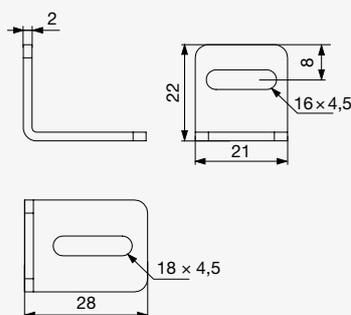

- Debljina 2 mm
- Boja bijela cink

Mjera [mm]	Kod
28 x 22	F004317

14

### ⊕ Riex JC49 Nosač

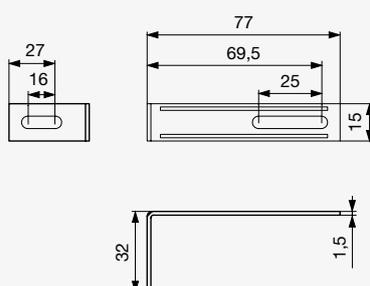

- Debljina 1,5 mm
- Boja bijela cink

Mjera [mm]	Kod
77 x 32	F003117

## ⊕ Riex JK13 kutna spojnica za ormar

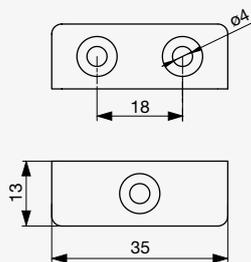

Boja

Kod

Bijela

F003111

## ● Priključak za IF postolje

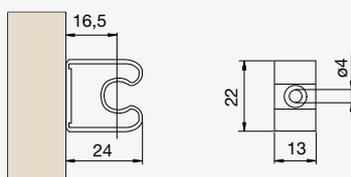

⊙ F003210

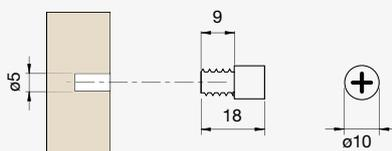

Tip

Kod

Ploča

F003210

Pin

F003211

⊙ F003211

# Dodaci za krevet i mehanizmi za podizanje

U odjeljku okova za krevete nudimo nekoliko sustava okova za spajanje okvira kreveta kako biste ih pravilno i čvrsto sastavili. Za naginjanje ili otvaranje skladišnih prostora u krevetima možete birati između nekoliko vrsta opružnih podizača kreveta, koji olakšavaju otvaranje često teških okvira kreveta.





---

● Pribor za krevete	15.3
---------------------	------

---

● Opužni podizači kreveta	15.7
---------------------------	------

# Pribor za krevete

## ➤ Potporna noga za krevet Riex JL10

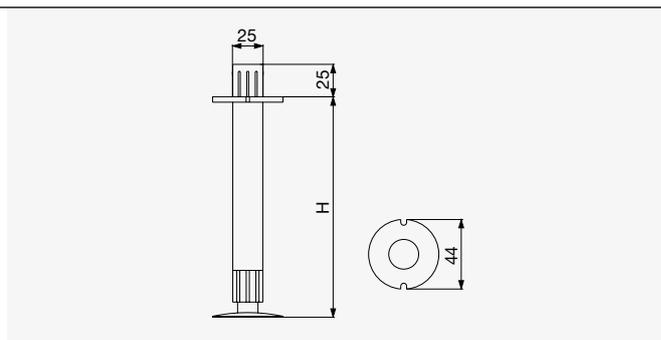

Visina H [mm]	Kod
120	F003011
160	F003012
190	F003013

## ➤ Riex JL10 adapter za potpornu nogu kreveta

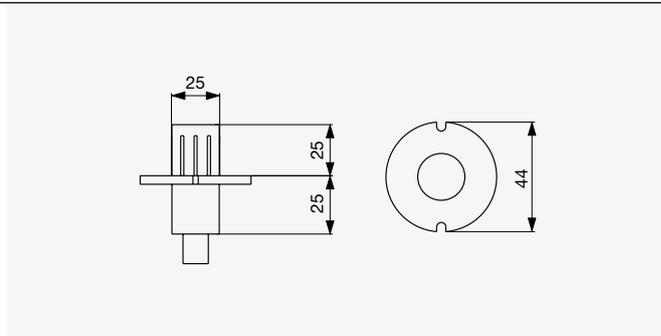

Proširenje [mm]	Kod
+50	F003014

15

## ⊕ Riex JF30 podesivi nastavak za krevet



⊕ F003556



⊕ F003098

- Debljina 2 mm
- Bijeli cink

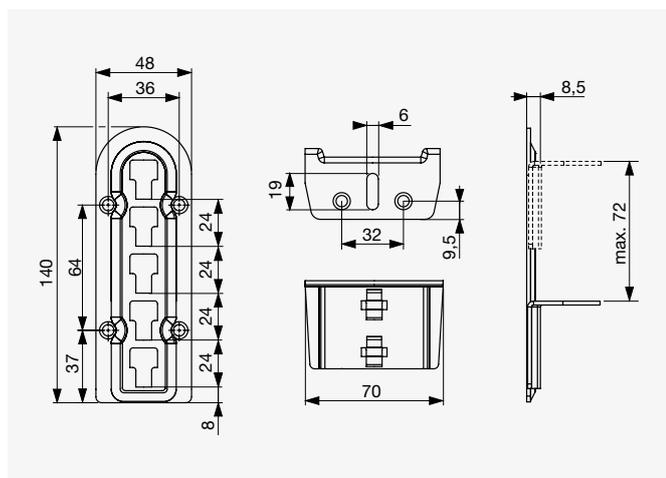

⊕ Kompletan set sastoji se od 1x F003556 and F003098.

Tip	Kod
Kot	F003556
Plošča	F003098

## ⊕ Riex JF50 središnji priključak za krevet



⊕ F003044

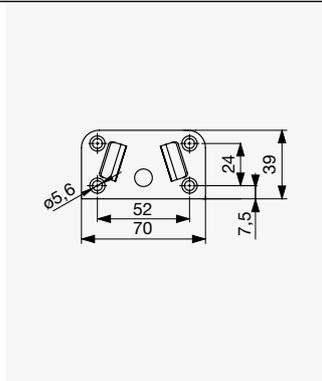

- Debljina 2 mm
- Bijeli cink



⊕ F003555

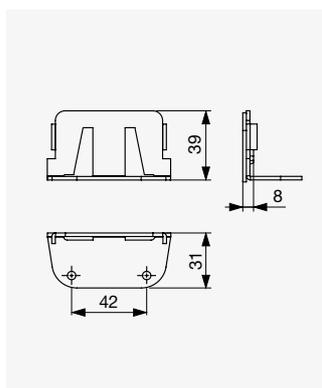

⊕ Kompletan set sastoji se od 1x F003555 and 1x F003044.

Tip	Kod
Kutnik	F003555
Pločica	F003044

### ⊕ Riex JK20 Poklopac L

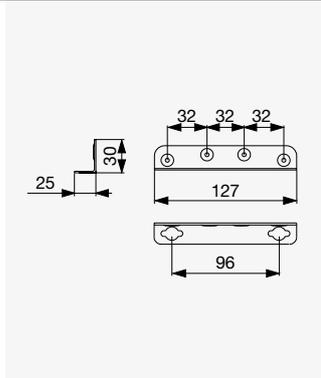

⊙ F003010

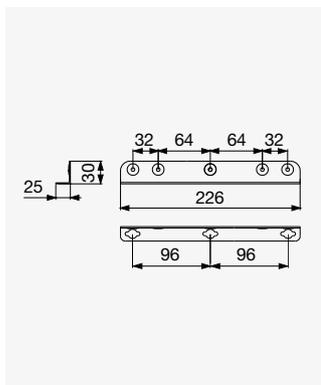

⊙ F003009

Duljina [mm]	Kod
127	F003010
226	F003009

### ⊕ Dodatak za krevet Riex JF40

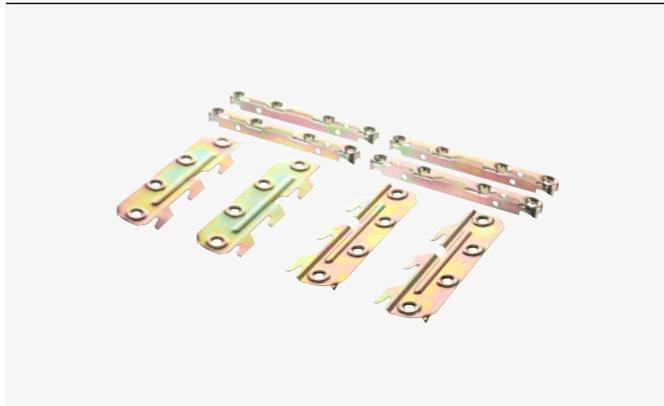

- Set za 1 krevet
- 4 para

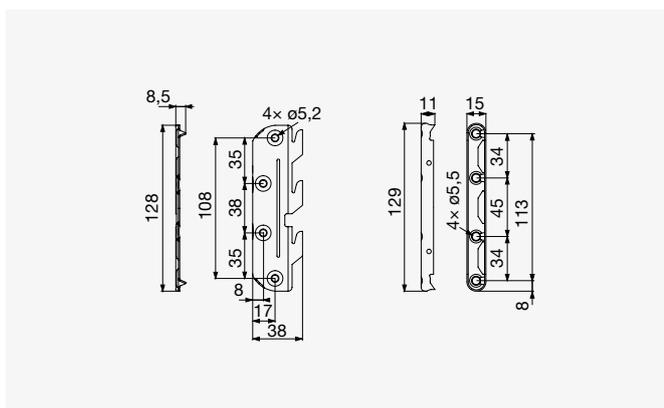

Duljina [mm]	Kod
129	F003042

● IF Spiralne



① F003083

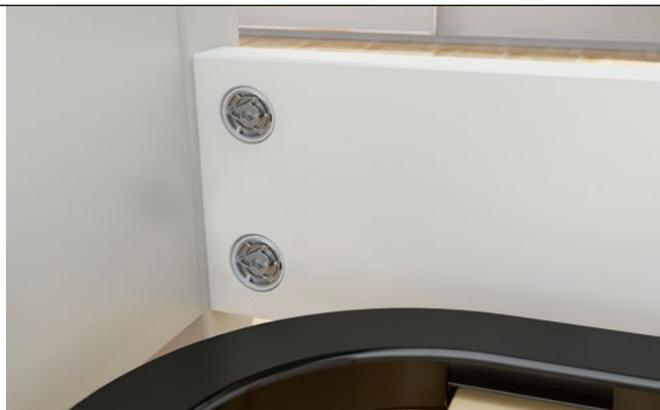
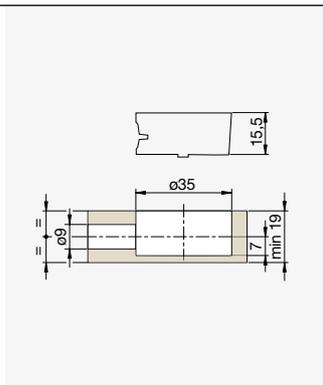

① F003084

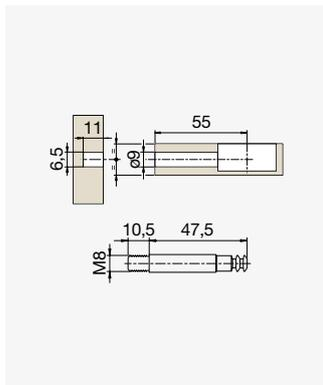

- Posebno dizajniran za spajanje stranica i panela kreveta
- Čvrsta veza bez oštećenja ploča
- Minimalna debljina ploče 19 mm

Za čvrst spoj, kombinirajte s umetnutom maticom F002530 – vidi str. 14.21.

Tip	Kod
Ekscentrična matica guma	F003083
Vijak	F003084

# Opružni podizači kreveta

## ⊕ Dizalica “škare” za krevet Riex JP81

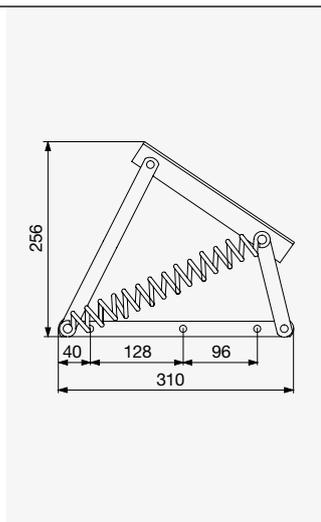

- Okvir kreveta
- Dugi bočni otvor
- Isporučuje se u paru

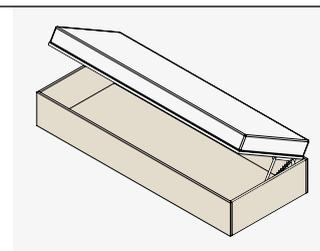

Broj opruga

Kod

1 opruga

F003330

## ⊕ Dizalica “škare” za krevet Riex JP82

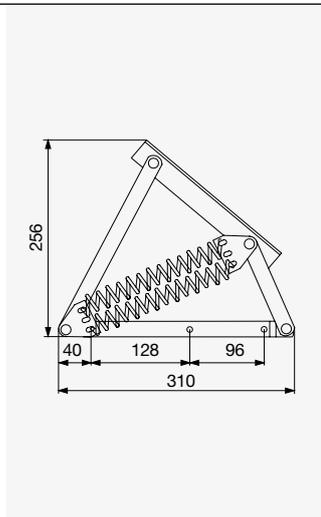

- Okvir kreveta
- Dugi ili kratki bočni otvor
- Isporučuje se u paru

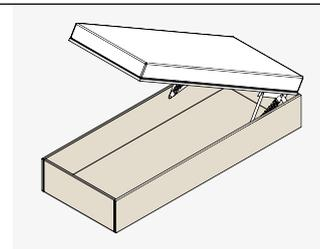

Broj opruga

Kod

2 opruge

F003331

15

## ⊕ Dizalica “škare” za krevet

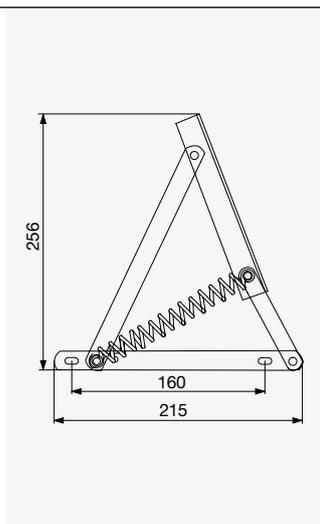

- Okvir kreveta
- Dugi bočni otvor
- Isporučuje se u paru

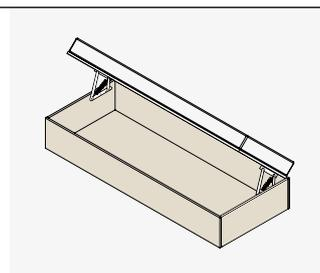

Broj opruga

Kod

1 opruga

F003332

## ⊕ Dizalica “škare” za krevet Riex JP84

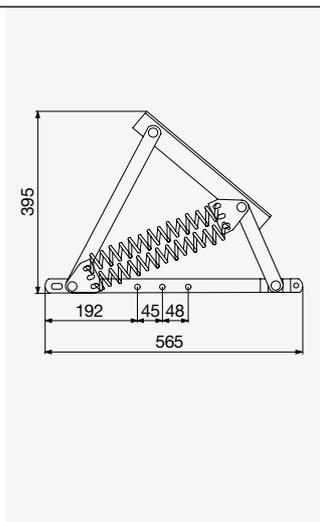

- Okvir kreveta
- Dugi bočni otvor
- Isporučuje se u paru

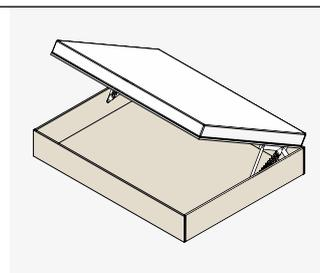

Broj opruga

Kod

2 opruge

F003333

## ⊕ Dizalica “škare” za krevet Riex JP86

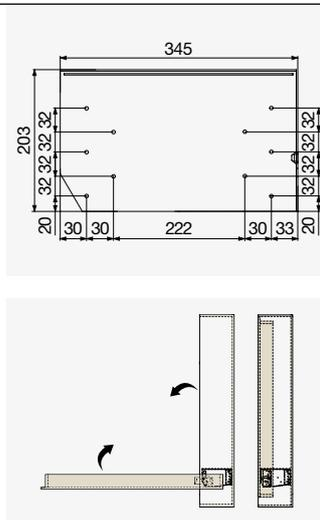

- Podizanje kreveta za skrivanje kreveta u ormaru
- Kompletan par mehanizama
- Sila podizanja se može podešavati
- Minimalna dubina ormara je 380 mm
- Maksimalna težina kreveta je 70 kg

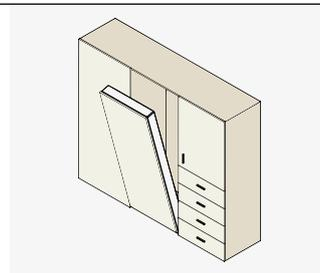

Broj opruga

Kod

Kutije s opružnim mehanizmom

F003572

01  
02  
03  
04  
05  
06  
07  
08  
09  
10  
11  
12  
13  
14  
15  
16  
17  
18

# Rubne trake za namještaj

Imamo savršeno usklađene rubne trake za više od 115 proizvođača ploča. Nudimo brojne usluge kao što su rezanje na mjeru, prematanje, nanošenje funkcionalnog sloja, lakiranje i dr.

- ABS rubovi
- Senosan ABS rubovi
- ABS AdvantEdge®
- ABS lakirani rubovi
- Akрил 3D
- Rubovi od melamina
- FALZ melaminski rubovi
- Furnirane rubne trake
- FALZ furnirane rubne trake
- Zbirke uzoraka





---

● **Usluge** **16.3**

---

● **Zbirke uzoraka** **16.7**

# Nudimo sveobuhvatne usluge



## Izrada ABS rubnih traka u netipičnim dimenzijama

Na zahtjev, možemo pripremiti netipične dimenzije i površine.

## ABS izrezan na mjeru

Rezanje ABS rubnih traka u netipičnim dimenzijama.

## Od 1 metra nadalje

U ponudi imamo rubove i jumbo role od 1 metra nadalje. Ne morate kupovati pune role ako ne morate. Uštedite novac i smanjite otpad.

## Nanošenje ljepila

Trebate li rubnu traku s već nanesenim ljepilom? Nije problem. Ljepilo se nanosi na rubne trake Hranipex kolekcije.

## Lakiranje

Možemo pripremiti bilo koju ABS rubnu traku u jednoj boji i sa stupnjem sjaja po vašem izboru. Koristimo lakove od 10° do 90° sjaja.

## Korištenje funkcionalnog sloja AdvantEdge®

Funkcionalni rubni sloj vrućim zrakom može se nanijeti na svaku ABS rubnu traku

## Dostupni su profesionalni savjeti

S našim iskusnim i profesionalnim timom možemo biti sigurni da ćemo vam ponuditi odgovarajuća ljepila, sredstva za čišćenje, ručna i strojna, koja će nadopuniti vaše proizvode.

## Pripremamo ljepila i sredstva za čišćenje po narudžbi

Trebate li kemiju koja u potpunosti odgovara vašim zahtjevima? Kroz vlastito istraživanje i razvoj, možemo osigurati specifična ljepila ili sredstva za čišćenje koja zadovoljavaju vaše potrebe bez kompromisa.

## ● Motanje kolutova

Decko	Debljina ruba [mm]	Duljina rolne [m]	Širina ruba
Boje ravnih rubova	Manje od 1 [0,45–0,8]	200	U skladu s ponudom dekora iz kolekcija; za netipične širine koristite obrazac u našoj e-trgovini.
	1	200	
	2	100	
	3	75	
ABS uzorci drva i drugi	Manje od 1 [0,45–0,8]	200	
	1	200	
	2	100	
	3	75	
ABS sjaj / mat i Senosan	1–2	150 / 200	
Kraj drva	1	200	
Akрил 3D	23 × 1	150	
	23 × 2	75	
	43 × 2	50	
Akрил 3D s efektom stakla	24 × 1	200	
ABS rubovi sa ALU folijom	0,5	200	Prema asortimanu dekora od zbirke; za netipične širine koristite na obrazac u našoj e-trgovini.
	1	200	
AdvantEdge® – Vrući zračni rubovi	2	100	
	1	150 / 200	
ABS rubovi koji se mogu bojati	0,8	200	
	1	150	
Rubovi od melamina	2	100	
	0,33	400–500	Rubovi prema širini jumbo rolne.
Lažni rubovi	100–500		
Slijepi rubovi od melamina		100–500	
Obložiti rubove ljepljivom	0,6	50	
Furnirani rubovi s flisom	0,6	200	
Rubovi od lažnog furnira	0,38	200	
Rubovi od melamina	1–2	50	
	4	Minimalna količina za narudžbu na zahtjev našeg prodajnog tima.	
Exwood	2	50	

📄 Za više informacija o svim uslugama i njihovim cijenama obratite se našem prodajnom timu.

## ● Rezanje

Tip	Debljina iskopa [mm]	Duljina cilindra u kolekciji [m]	Rezanje iz jumbo role [mm]
Boje ravnih rubova	0,45–0,7	200	Od 16 do 200 *
	0,8–1	200	Od 12 do jumbo širine role **
	2	100	
ABS uzorci drva i drugi	0,45–0,7	200	Od 16 do 200
	0,8–1	200	Od 12 do jumbo širine role **
	2	100	
ABS sjaj / mat i Senosan	1	150 / 200	Od 12 do jumbo širine role **
	2	100	
Drveni kraj	1	200	Od 12 do jumbo širine role **
ABS rubovi sa ALU folijom	0,5	200	Od 16 do 200 **
	1	200	Od 12 do jumbo širine role **
	2	100	
ABS rubovi koji se mogu bojati	0,8	200	Od 12 do jumbo širine role **
	1	200	
	2	100	
Rubovi od melamina		100–500	Od 16 do 200 *
Lažni rubovi		400–500	Od 16 do 200 *
Melaminske slijepe rubove		100–500	

\* Izrežite punu širinu jumbo rollice – dobit ćete više rola na temelju potrebne širine ruba.

\*\* Samo višekratnik minimalne količine narudžbe.

## ● Izrada ABS rubova netipičnih dimenzija i površina u običnim bojama

- Unutar 10 radnih dana za Vas ćemo izraditi bilo koju veličinu od više od 150 netipičnih dimenzija rubova u odabranoj površinskoj obradi. Duljina od 100 m. Za više informacija, rokove isporuke i izračun obratite se našem prodajnom timu.

## ● Nanošenje ljepila

Tip	Debljina trake [mm]	Minimalna količina za narudžbu s ljepljivom [m]	Širina ruba – prilagođena aplikacija ljepila u širini [mm]
ABS glatki rubovi u boji	0,45–0,7	10	16–160
	0,8–1	10	12–160
	2	10	
ABS uzorci drva i drugi	0,45–0,7	10	16–160
	0,8–1	10	12–160
	2	10	
ABS sjaj / mat i Senosan	1–2	10	12–160
Kraj drva	1	10	12–160
Acrylic 3D	1–2	10	Može se koristiti za dimenzije ruba u kolekciji.
	2		
Akriil 3D s efektom stakla	1	10	Može se koristiti za dimenzije ruba u kolekciji.
ABS rubovi sa ALU folijom	0,5	10	16–160
	1	10	12–160
	2		
ABS rubovi koji se mogu bojati	1	10	12–160
	2		
Rubovi od melamina		50	22 do 45
		100	16–160
Lažni rubovi		100	60
		100	16–160
Slijepi rubovi od melamina		50	22 do 45
		100	16–160

## ● Upotreba funkcionalnog sloja

Tip	Debljina rubne trake [mm]	Duljina role [m]	Minimalna količina narudžbe	Širina rubne trake [mm]	Boja
Jednobojni rubovi	0,8–1	150 / 200	1 puna rola	12–65	Transparentan Natural Bijela Crno
	2	100			
Uzorci ABS drvnog dekora i drugi	0,8–1	200			
	2	100			

## ● Lakiranje

Rubne trake lakiramo debljine od 0,45 mm do 3 mm i sjaja od 10° do 90°.

Lak se može nanositi samo na odabrane površine.

Za više informacija, rokove isporuke i izračune obratite se našem prodajnom timu.

ⓘ Informacije o pakiranju, skladištenju i toleranciji naših rubova možete pronaći u našoj e-trgovini. Molimo kontaktirajte naš prodajni tim za detalje i cijene.

# Zbirke uzoraka



Uzorci ABS Edge lanca  
u kutiji



ABS rubne trake visokog sjaja  
s uzorkom lanca



Uzorci Senoplast  
rubnih traka



Kreiranje uzoraka  
rubnih traka u lančiće



Čeoni uzorci cjelovitog drva  
na ABS rubnoj traci kao lančić uzorak



Uzorci ABS matt  
rubnih traka



AdvantEdge® ABS  
uzorci rubnih traka



Ogledni set melaminskih  
rubnih traka



Set uzoraka  
melaminskih FALZ rubnih traka



Set lančiča od uzoraka rubnih traka  
furnira od 0'6, 1 i 2 mm

# Ljepila

Možemo vam pomoći pri odabiru ljepila za različite primjene. Nudimo ljepila za oblaganje rubova, disperzije i ljepila u spreju. Pružamo smjernice o tome koja su ljepila prikladna za vaše potrebe i koji bi vam dodatni proizvodi koristili.





● <b>Vruće taljiva ljepila</b>	<b>17.3</b>
Vruće taljiva EVA ljepila	17.4
Vruće taljiva PUR ljepila	17.11
● <b>Hranipex disperzivna ljepila</b>	<b>17.13</b>
● <b>Kontaktna ljepila i aditivi</b>	<b>17.15</b>
Kontaktna ljepila	17.16
Pribor	17.19
● <b>Dvostrane trake i pribor</b>	<b>17.21</b>
● <b>Montažna i građevinska ljepila</b>	<b>17.23</b>
Ljepilo – PUR	17.24
Silikoni	17.26
Polimeri	17.27
Dodaci	17.28

# Vruće taljiva ljepila

---

- Ljepila za različite strojeve za oblaganje rubova i različite primjene.



# EVA vruće taljiva ljepila

## ● Granule Hranitherm

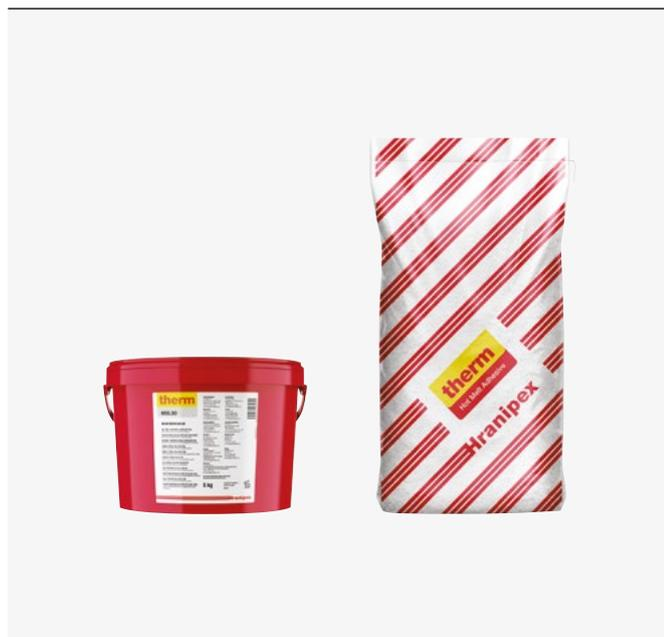

- Ljepila bez punila

Hranitherm	600.30 prozirna 600.31 bijela boja 600.39 crna boja	603.00 prozirna 603.01 bijela boja	608.30 prozirna 608.31 bijela boja
Tehničke informacije			
Pakiranje	5; 20 kg	5; 20 kg	5; 20 kg
Osnova	EVA bez punila	EVA bez punila	EVA bez punila
Točka omekšavanja [Ring and Ball]	110 °C	110 °C	92–102 °C
Radna temperatura	180–200 °C	180–200 °C	190–210 °C
Brzina rada	12–30 m / min	8–30 m / min	4–8 m / min
Viskoznost na 200 °C	Oko 70 000 mPa·s	Oko 70 000 mPa·s	Oko 60 000 mPa·s
<b>Područje primjene</b>			
ABS, PVC i PP rubovi s temeljnim premazom	***	***	***
Rubovi od furnira	***	***	***
Rubovi od melamina	***	***	***
Rubovi od punog drveta	**	**	**
Softforming	***	***	***
CNC obrađeni rubovi	***	***	**
Ručno oblikovani rubovi	**	**	**
HOLZ-HER patronski uređaji	x	x	x

\*\*\* vrlo prikladno   \*\* prikladno   • tehnički moguće

## ● Granule Hranitherm

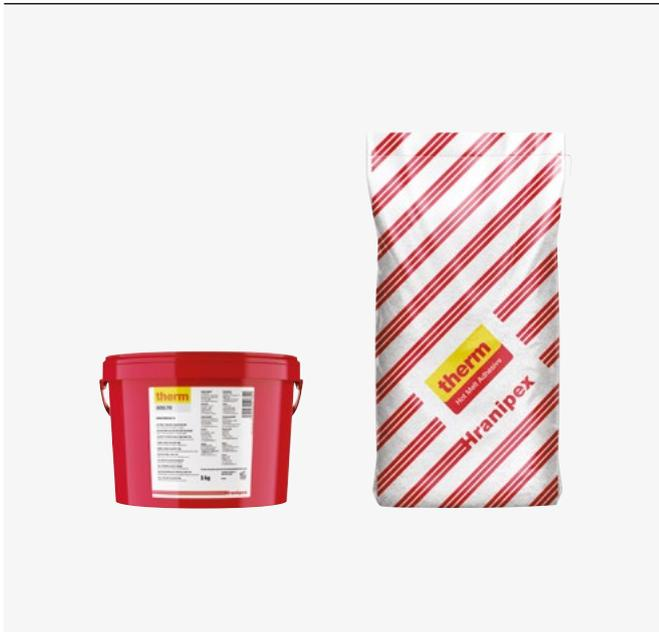

- Ljepila s djelomičnim udjelom punila

Hranitherm	600.70 natur 600.71 bijela boja 600.79 crna boja	617.00 natur 617.01 bijela boja	628.10 natur
Tehničke informacije			
Pakiranje	5; 25 kg	5; 25 kg	20 kg
Osnova	EVA s dodatkom punila	EVA s dodatkom punila	EVA s dodatkom punila
Točka omekšavanja [Ring and Ball]	100 °C	96 °C	110 °C
Radna temperatura	190–210 °C	190–210 °C	190–210 °C
Brzina rada	10–60 m / min	10–50 m / min	18–30 m / min
Viskoznost na 200 °C	Oko 60 000 mPa·s	Oko 65 000 mPa·s	140 000–170 000 mPa·s
<b>Područje primjene</b>			
ABS, PVC i PP rubovi s temeljnim premazom	***	***	***
Rubovi od furnira	***	***	***
Rubovi od melamina	***	***	***
Rubovi od punog drveta	**	**	**
Softforming	**	**	**
CNC obrađeni rubovi	**	**	**
Ručno oblikovani rubovi	**	**	**
HOLZ-HER patronski uređaji	x	x	x

## ● Granule Hranitherm

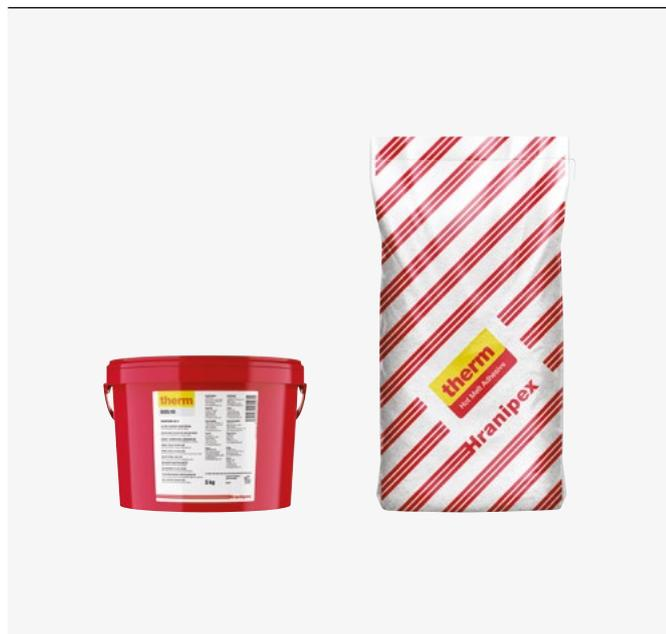

- Ljepila sa punilom

Hranitherm	600.10 natur	600.11 bijela boja 600.18 smeđa 600.19 crna boja	600.64 natur
Tehničke informacije			
Pakiranje	5; 25 kg	5; 25 kg	5; 25 kg
Osnova	EVA sa punilima	EVA sa punilima	EVA sa punilima
Točka omekšavanja [Ring and Ball]	95 °C	95 °C	100 °C
Radna temperatura	190–210 °C	190–210 °C	190–210 °C
Brzina rada	10–30 m / min	10–30 m / min	10–50 m / min
Viskoznost na 200 °C	Oko 65 000 mPa·s	Oko 80 000 mPa·s	Oko 65 000 mPa·s

Područje primjene	600.10 natur	600.11 bijela boja 600.18 smeđa 600.19 crna boja	600.64 natur
ABS, PVC i PP rubovi s temeljnim premazom	***	***	***
Rubovi od furnira	**	***	***
Rubovi od melamina	***	***	***
Rubovi od punog drveta	x	x	**
Softforming	**	**	**
CNC obrađeni rubovi	x	x	x
Ručno oblikovani rubovi	x	x	x
HOLZ-HER patronski uređaji	x	x	x

\*\*\* vrlo prikladno   \*\* prikladno   • tehnički moguće

## ● Granule Hranitherm



**Hranitherm granule:**  
 • Ljepila s punilima

Hranitherm	608.80 svijetlo bež
Tehničke informacije	
Pakiranje	5; 25 kg
Osnova	EVA s punilima
Točka omekšavanja [Ring and Ball]	95 °C
Radna temperatura	190–210 °C
Brzina rada	4–8 m / min
Viskoznost na 200 °C	Oko 50 000 mPa·s
<b>Područje primjene</b>	
ABS, PVC i PP rubovi s temeljnim premazom	•••
Rubovi od furnira	•••
Rubovi od melamina	•••
Rubovi od punog drveta	•••
Softforming	•••
CNC obrađeni rubovi	•••
Ručno oblikovani rubovi	•••
HOLZ-HER patronski uređaji	x

## ● Granule Hranitherm



**Hranitherm granule:**  
• Niske točke taljenja

Hranitherm	600.20 natur 600.21 bijela boja	605.20 natur 605.21 bijela boja
Tehničke informacije		
Pakiranje	5; 25 kg	5; 25 kg
Osnova	EVA sa punilima	EVA sa punilima
Točka omekšavanja [Ring and Ball]	85 °C	80 °C
Radna temperatura	160–180 °C	140–160 °C
Brzina rada	8–15 m / min	4–15 m / min
Viskoznost na 200 °C	Oko 10 000 mPa·s	10 000–14 000 mPa·s
<b>Područje primjene</b>		
ABS, PVC i PP rubovi s temeljnim premazom	•••	•••
Rubovi od furnira	•••	•••
Rubovi od melamina	•••	•••
Rubovi od punog drveta	••	••
Softforming	••	••
CNC obrađeni rubovi	x	x
Ručno oblikovani rubovi	•••	•••
HOLZ-HER patronski uređaji	x	x

••• vrlo prikladno •• prikladno • tehnički moguće

## ● Patrone Hranitherm



Hranitherm	600.70 natur 600.71 bijela boja	603.00 prozirna 603.01 bijela boja
Tehničke informacije		
Pakiranje	1 uložak; kutija 7,2 kg [24 patrone]	1 uložak; kutija 6 kg [24 patrone]
Osnova	EVA s dodatkom punila	EVA bez punila
Točka omekšavanja [Ring and Ball]	100 °C	110 °C
Radna temperatura	190–210 °C	190–210 °C
Brzina rada	14–35 m / min	8–30 m / min
Viskoznost na 200 °C	Oko 60 000 mPa·s	70 000 mPa·s
<b>Područje primjene</b>		
ABS, PVC i PP rubovi s temeljnim premazom	***	***
Rubovi od furnira	***	***
Rubovi od melamina	***	***
Rubovi od punog drveta	**	**
Softforming	x	x
CNC obrađeni rubovi	x	x
Ručno oblikovani rubovi	x	x
HOLZ-HER patronski uređaji	***	***
Festool uređaji za patrone	x	x



## ● Patrone Hranitherm



Hranitherm	1000.30 prozirna 1000.31 bijela boja	1000.70 natur 1000.71 bijela boja	600.00 natur 600.01 bijela boja
Tehničke informacije			
Pakiranje	1 uložak; Kutija 6 kg [72 patrone]	1 uložak; Kutija 7,2 kg [72 patrone]	1 uložak; Kutija 8 kg [24 patrone]
Osnova	EVA bez punila	EVA s dodatkom punila	EVA sa punilima
Točka omekšavanja [Ring and Ball]	110 °C	100 °C	95 °C
Radna temperatura	190–210 °C	190–210 °C	190–210 °C
Brzina rada	2–5 m / min	2–5 m / min	10–40 m / min
Viskoznost na 200 °C	70 000 mPa·s	60 000 mPa·s	65 000 mPa·s
<b>Područje primjene</b>			
ABS, PVC i PP rubovi s temeljnim premazom	***	***	***
Rubovi od furnira	**	***	***
Rubovi od melamina	***	***	***
Rubovi od punog drveta	x	x	x
Softforming	x	x	x
CNC obrađeni rubovi	x	x	x
Ručno oblikovani rubovi	x	x	x
HOLZ-HER patronski uređaji	x	x	***
Festool uređaji za patrone	***	***	x

\*\*\* vrlo prikladno   \*\* prikladno   • tehnički moguće

01  
02  
03  
04  
05  
06  
07  
08  
09  
10  
11  
12  
13  
14  
15  
16  
17  
18

# PUR taljiva ljepila

## ● Hranitherm mini patrone



Hranitherm	10.830 prozirna	10.850 natur 10.851 bijela boja	10.860 djelomično prozirna 10.861 bijela boja
Tehničke informacije			
Pakiranje	1 kg	1 kg	1 kg
Osnova	PUR	PUR	PUR
Područje omekšavanja prema Kofleru	x	x	x
Radna temperatura	135–150 °C	145–160 °C	145–160 °C
Brzina rada	8–30 m / min	8–30 m / min	8–30 m / min
Viskoznost na 140 °C	50 000 mPa·s	65 000 mPa·s	55 000 mPa·s
<b>Područje primjene</b>			
ABS, PVC i PP rubovi s temeljnim premazom	***	***	***
Rubovi od furnira	***	***	***
Rubovi od melamina	***	***	***
Rubovi od punog drveta	***	**	***
Softforming	***	***	**
CNC obrađeni rubovi	**	**	**
Ručno oblikovani rubovi	**	**	**
HOLZ-HER patronski uređaji	x	x	x

\*\*\* vrlo prikladno •• prikladno • tehnički moguće

## ● Patrone Hranitherm

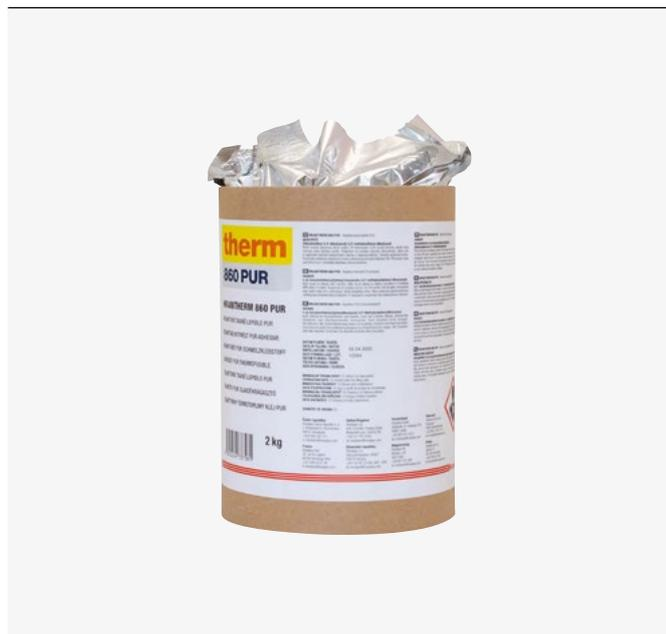

Hranitherm	830 prozirna	850 natur 851 bijela boja	860 djelomično prozirna 861 bijela boja
Tehničke informacije			
Pakiranje	2 kg	2,5 kg	2 kg
Osnova	PUR	PUR	PUR
Područje omekšavanja prema Kofleru	x	x	x
Radna temperatura	130–150 °C	140–160 °C	140–160 °C
Brzina rada	8–30 m / min	8–30 m / min	8–30 m / min
Viskoznost na 140 °C	50 000 mPa·s	65 000 mPa·s	55 000 mPa·s
<b>Područje primjene</b>			
ABS, PVC i PP rubovi s temeljnim premazom	***	***	***
Rubovi od furnira	***	***	***
Rubovi od melamina	***	***	***
Rubovi od punog drveta	***	***	***
Softforming	**	**	**
CNC obrađeni rubovi	**	**	**
Ručno oblikovani rubovi	x	x	x
HOLZ-HER patronski uređaji	x	x	x

\*\*\* vrlo prikladno \*\* prikladno • tehnički moguće

# Hranipex disperzivna ljepila

- Ljepila za lijepljenje punog drva, furnira, HPL-a ili tipli



## ● Disperzivna ljepila Hranipex



	Hranicoll D3	Hranicoll D3E	Hranicoll D3 SMART	Hranicoll D4	Hranicoll DW
<b>Tehničke informacije</b>					
Pakiranje*	800 ml	5; 10; 30 kg; IBC 1050 kg	5; 10; 30 kg; IBC 1100 kg	800 ml; 5 kg; 25 kg	20 kg
Osnova	PVAc	PVAc	PVAc	PVAc	PVAc
U skladu s normom EN 204	D3	D3	D3	D4	x
Otvoreno vrijeme / min na 20 °C	5–8	10–14 [prikaz, ostalo]	12–15 [prikaz, stručni]	8–12 [prikaz, ostalo]	x
<b>Područje primjene</b>					
Lijepljenje namještaja	***	***	***	***	x
Meko drvo	***	***	***	***	x
Tvrdo drvo	***	**	***	***	x
Prozori i vrata	**	**	***	***	x
Ravno lijepljenje furnira, HPL	**	**	***	***	x
3D lijepljenje u vakuumskoj preši	x	x	x	x	x
Automatsko lijepljenje drvenih tipli	x	x	x	x	***

\*\*\* vrlo prikladno \*\* prikladno • tehnički moguće

\* Određena pakiranja nisu moguća u Vašoj zemlji. Za dostupnost pakiranja molimo Vas da se obratite Vašem prodajnom predstavniku.

# Kontaktna ljepila i aditivi

- Za brzo lijepljenje raznih vrsta materijala, uključujući i neupijajuće



# Kontaktna ljepila

## ● Hranipex kontaktna ljepila



	Hranifix Premium	Hranifix industrija
<b>Tehničke informacije</b>		
Pakiranje*	Sprej 500 ml; Karton [12 komada] 17; posude od po 47,5 kg	posude od 17 kilograma
Osnova	Polikloropren	Polikloropren
Minimalno otvoreno vrijeme / min na 20 °C	2–5	2–5
Suha tvar	38–42 %	28–34 %
<b>Primjena</b>		
Ručno, paletnim nožem, četkom ili valjkom	×	×
Prskanjem	•••	•••
<b>Područje primjene</b>	Pogodno za lijepljenje MDF-a, DTD-a, poliuretanske pjene, laminati i mnogi plastični materijali [isklj. plastifikatori], ABS, aluminijски listovi u većini metala kao i drveni podovi, PVC i drugi materijali. Voda otporan na kontakt, otpornost na visoke temperature 130 °C.  Za postupak nanošenja potrebno je kupiti crijevo i pištolj.	Pogodno za lijepljenje MDF-a, DTD-a, poliuretanske pjene, laminati i mnogi plastični materijali [bez plastifikatora], ABS, aluminijске ploče, većina metala i također drvo podne obloge, PVC i drugi materijali. Vodootporan kontakt, otpornost na visoke temperature od 85 °C. Cijev i pištolj preporuča se kupiti za postupak prijave.

••• vrlo prikladno •• prikladno • tehnički moguće

\* Određena pakiranja nisu moguća u Vašoj zemlji. Za dostupnost pakiranja molimo Vas da se obratite Vašem prodajnom predstavniku.

## ● Hranipex kontaktna ljepila



	Hranifix Smart	Hranifix DCM Free
<b>Tehničke informacije</b>		
Pakiranje*	Sprej 500 ml; Karton [12 komada]; 17; bačve od po 47,5 kg	Sprej 500 ml; Karton [12 komada]; 17; bačve od po 47,5 kg
Osnova	Polikloropren	Polikloropren
Minimalno otvoreno vrijeme / min 20 °C	2-5	2-5
Suha tvar	28-32 %	38-42 %
<b>Primjena</b>		
Ručno, paletnim nožem, četkom ili valjkom	×	×
Prskanjem	•••	•••
<b>Područje primjene</b>		
	Dizajniran za lijepljenje mnogih podloga, uključujući: dekorativne laminatne na iveralu, furniru, drvu, MDF-u, plastici [bez plastifikatora], guma, presvlake i mnogi drugi materijali. Vodootporan, temperaturna stabilnost 105 °C.  Za postupak nanošenja potrebno je kupiti crijevo i pištolj.	Pogodno za lijepljenje drva, iverice, MDF-a, DTD-a, poliuretanska pjena, laminati, karton, većina plastike [bez plastifikatora], ABS, aluminijski lim i većina metala, PVC podovi i drugi materijali. Ljepljeni spoj je otporan na vodu i temperature do 130 °C. Ne sadrži diklorometan.  Za postupak nanošenja potrebno je kupiti crijevo i pištolj.

••• vrlo prikladno •• prikladno • tehnički moguće

\* Određena pakiranja nisu moguća u Vašoj zemlji. Za dostupnost pakiranja molimo Vas da se obratite Vašem prodajnom predstavniku.



● Hranipex kontaktna ljepila



	Hranicon 30	Hranicon 50
<b>Tehničke informacije</b>		
Pakiranje*	1 l; limenka od 5 l	1 l; limenka od 20 l
Osnova	Polikloropren	Polikloropren
Minimalno otvoreno vrijeme / min 20 °C	2–5	3–10
Struktura proizvoda	1-komponentna tekućina – veća viskoznost	1-komponentna tekućina – niža viskoznost
<b>Primjena</b>		
Ručno, paletnim nožem, četkom ili valjkom	•••	•••
Prskanjem	•••	•••
<b>Područje primjene</b>		
Površinsko lijepljenje MFC i MDF ploča	•••	•••
Hladno temperaturno lijepljenje HPL, CPL na iveral ili MDF	•••	•••
Lijepljenje gume, filca, pjene i mnogih vrsta plastike [bez plastifikatora] na metale	•••	•••
Niske temperature	•••	•••

••• vrlo prikladno •• prikladno • tehnički moguće

\* Određena pakiranja nisu moguća u Vašoj zemlji. Za dostupnost pakiranja molimo Vas da se obratite Vašem prodajnom predstavniku.

01  
02  
03  
04  
05  
06  
07  
08  
09  
10  
11  
12  
13  
14  
15  
16  
17  
18

# Pribor

## ● Crijevo

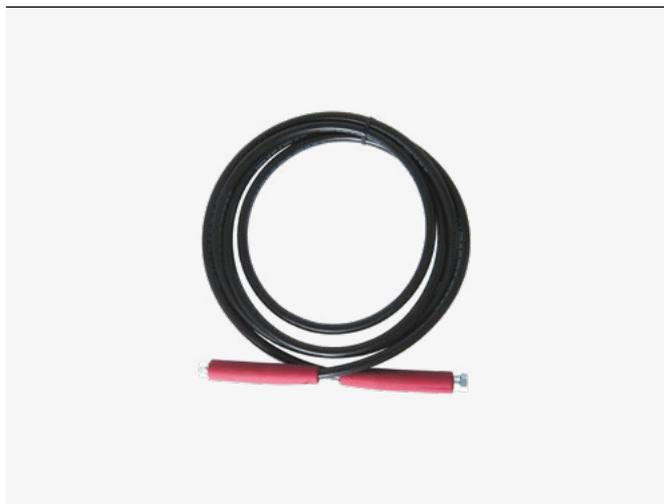

Hranifix cijev 3,6 m  
– važan alat za pravilno nanošenje ljepila iz posude

## ● Pištolj za nanos ljepila



Hranifix pištolj  
– važan alat za pravilno nanošenje ljepila iz posude

## ● Pritisni valjci



Hranifix pritisni valjci  
– dostupna standardna ili produžena dužina

## ● Sredstvo za čišćenje



Hranifix sredstvo za čišćenje, 17 kg\*  
– za čišćenje crijeva za nanošenje i pištolja

●●● vrlo prikladno ●● prikladno ● tehnički moguće

\* Određena pakiranja nisu moguća u Vašoj zemlji. Za dostupnost pakiranja molimo Vas da se obratite Vašem prodajnom predstavniku.



# Ljepljive trake i pribor

---

- Ljepljive trake za brzo  
i čisto pričvršćivanje ploča  
i ostale montažne radove



# Traka

## ● Hranitape UNI



Hranitape UNI	
<b>Tehničke informacije</b>	
Pakiranje	1 komad
Skateboard	50 m
Širina	15; 34 mm
Debljina	0,200 mm
Boja	Prozima
<b>Područje primjene</b>	
Za pričvršćivanje i lijepljenje ravnih materijala. Prikladno za glatke i vrlo grubo strukturirane materijale [npr. melamin, OSB ploče].	

# Pribor

## ● Hranitape ručni aplikator

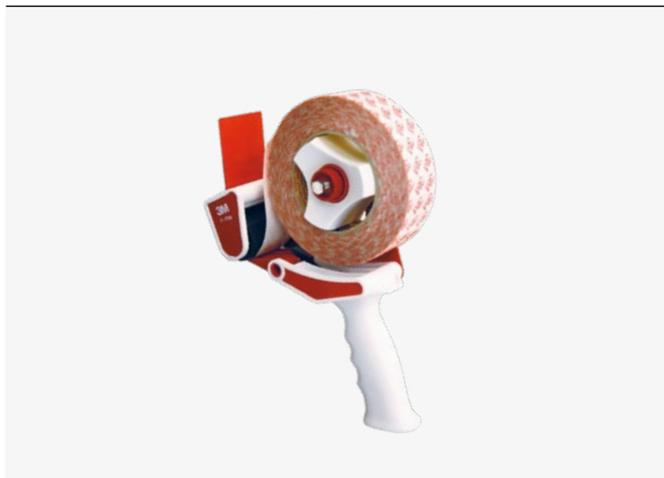

Pakiranje	Područje primjene
1 kom	Za glatko i jednostavno nanošenje Hranitape trake

# Montažna i građevinska ljepila

- 
- Ljepila za brzo lijepljenje, brtvljenje i montažu



# Ljepilo – PUR

## ● Ljepilo – PUR

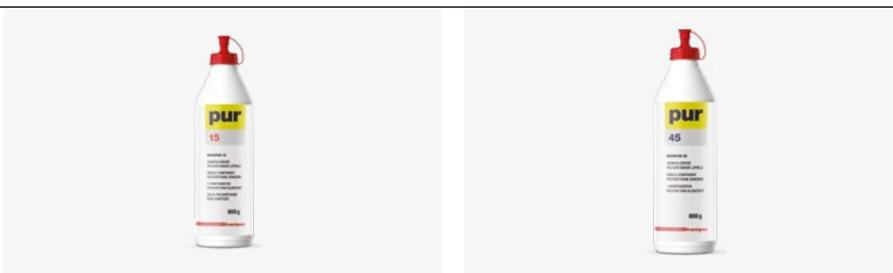

	Hranipur 15	Hranipur 45
<b>Tehničke informacije</b>		
Pakiranje	1 komad 800 g; Karton [12 komada]	1 komad 800 g; Karton [12 komada]
Osnova	PUR predpolimer	PUR predpolimer
Otvoreno vrijeme / min. na 20 °C	15–25	25–45
Minimalno vrijeme prešanja u min. na 20 °C	60	120
<b>Područje primjene</b>		
Sastav mekog drveta	••	•••
Sastav tvrdog i tropskog drva	×	×
Površinsko lijepljenje MFC i MDF ploča	•••	•••
Ravno lijepljenje HPL, CPL na iveral ili MDF hladnom temperaturom	••	•••
Dizajn furnira s jednoslojnim lijepljenjem	••	••
Lijepljenje polistirenske pjene	•••	•••
Lijepljenje boja, metala, betona, keramike	••	••

••• vrlo prikladno •• prikladno • tehnički moguće

## ● Ljepilo – PUR



	Hranipur SPEED	Hranipur 05
<b>Tehničke informacije</b>		
Pakiranje*	Patrone 310 ml; Karton [15 komada]	Patrone 310 ml; Karton [24 komada]
Osnova	PUR prepolimer	PUR prepolimer
Otvoreno vrijeme / min. na 20 °C	0,5 [30 sekundi]	5–10
Minimalno vrijeme prešanja u min. na 20 °C	5–10 [prikaz, ostalo]	15–20 [prikaz, stručni]
<b>Područje primjene</b>		
Sastav mekog drveta	***	***
Sastav tvrdog i tropskog drva	••	••
Površinsko lijepljenje MFC i MDF ploča	***	***
Ravno lijepljenje HPL, CPL na iveral ili MDF hladnom temperaturom	×	••
Dizajn furnira s jednoslojnim lijepljenjem	×	••
Lijepljenje polistirenske pjene	***	***
Lijepljenje za boje, metale, beton, keramiku	••	••

\*\*\* vrlo prikladno •• prikladno • tehnički moguće

\* Određena pakiranja nisu moguća u Vašoj zemlji. Za dostupnost pakiranja molimo Vas da se obratite Vašem prodajnom predstavniku.



# Silikoni

## ● Građevinsko ljepilo



	H – silikon prozirni	H – silikon bijeli	H – silikon ogledalo
<b>Tehničke informacije</b>			
Pakiranje	Kartuše 310 ml; Karton [15 komada]	Kartuše 310 ml; Karton [15 komada]	Kartuše 310 ml; Karton [15 komada]
Osnova	Silikon	Silikon	Alkoxy silikon
Vrsta otvrdnjavanja	Acetat	Acetat	Neutralna alkoksi skupina
Vrijeme obrade	Oko 25 min	Oko 25 min	Oko 10 min
Vrijeme stvrdnjavanja	2 mm / 24 sata [relativna vlažnost 55%]	2 mm / 24 sata [relativna vlažnost 55%]	2 mm / 24 sata [relativna vlažnost 55%]
Radna temperatura	Od 5 do 40 °C	Od 5 do 40 °C	Od 5 do 40 °C
Otpornost na toplinu	Od -40 do +180 °C	Od -40 do +180 °C	Od -40 do +180 °C
<b>Područje primjene</b>			
	Svestrana upotreba, pogodna za ostakljivanje, brtvljenje pregrada, prozorskih klupica itd. Nije prikladno za lijepljenje ogledala, akvarija i naturg kamena ili nezaštićenih metala.	Svestrana upotreba, pogodna za ostakljivanje, brtvljenje pregrada, prozorskih klupica itd. Nije prikladno za lijepljenje ogledala, akvarija i naturg kamena ili nezaštićenih metala.	Prikladno za pričvršćivanje dekorativnih ogledala na različite podloge kao što su glazura, staklo, gips, beton, OSB ploče, drvo, šperploča itd. Koristan je i za lijepljenje zrcalnih mozaika [mirror to mirror], ogledala u kupaonicama i na podovima koji mogu biti izloženi vibracijama i napetosti.

# Polimeri

## ● Građevinsko ljepilo



	H – Polimer MS bijela, crna, prozirna	H-Polimer STP proziran
Tehničke informacije	○ ● ◉	◉
Pakiranje*	Kartuše 290 ml; Karton [15 komada]	Kartuše 290 ml; Karton [15 komada]
Osnova	Hibridni polimer	Hibridni polimer
Vrsta otvrdnjavanja	Neutralna alkoksi skupina	Neutralna alkoksi skupina
Vrijeme obrade	Oko 6 min	Oko 6 min
Vrijeme stvrdnjavanja	2–3 mm / 24 sata	2–3 mm / 24 sata
Temperatura primjene	Od 5 do 35 °C	Od 5 do 35 °C
Otpornost na toplinu	Od –40 do +90 °C	Od –40 do +90 °C
<b>Područje primjene</b>	Pogodan za lijepljenje i brtvljenje svih građevinskih materijala - kamen, drvo, beton, metal, cigla, staklo, keramika, gips, poliuretani, plastika, šperploča itd. Pogodan je i za elastične spojeve u vibrirajućim konstrukcijama, za spajanje elemenata od pocinčanog čeličnog lima, mesinga i drugih metala.	Pogodan za lijepljenje i brtvljenje u unutarnjim i vanjskim prostorima, otporan na ekstremne vremenske uvjete i UV zračenje. Primjenjivo na većinu materijala [ogledala, aluminij, polikarbonat, drvo, plastika, građevinski materijali], vodootporan, proziran.

# Pribor

## ● Hranipex pištolj za nanošenje



### Pakiranje

Visokokvalitetni praktični pištolji dizajnirani za dugotrajnu upotrebu bez napora [učinkovito opremanje]. Također vrlo pogodan za nanošenje H-silikona i H-polimera.

1 komad

# Sredstva za čišćenje

Mi ćemo vam preporučiti i isporučiti sredstva za čišćenje, bilo da radite sa strojem za oblaganje rubova ili ručno.



---

● Sredstva za čišćenje Hranipex	18.3
Sredstva za ručno čišćenje ploča	18.4
Sredstva za čišćenje PUR	18.6
Pribor	18.6

# Hranipex sredstva za čišćenje

- Za ručno čišćenje



# Sredstva za ručno čišćenje

## ● Hraniclean 01



Specijalno sredstvo za čišćenje Hraniclean 01 na bazi ugljikovodika i alkohola ne sadrži agresivna otapala. Hraniclean 01 za čišćenje plastike ima sljedeće karakteristike: jaka moć čišćenja, brzo sušenje, bez isparavanja, ostataka i ugodnog mirisa citrusa. Ne ostavlja masne tragove i može očistiti ostatke ljepila, olovke i markera.

Za čišćenje koristite čistu krpu ili papirnati ručnik.

### Pakiranje

Ručni čistač za čišćenje plastike

1 l; 5 l; 20 l

## ● Hraniclean 03



Uklanja i otapa nestvrdnuta ljepila na bazi poliuretana [PUR ljepila]. Sredstvo namijenjeno za čišćenje alata, može se koristiti za uklanjanje PUR pjene i PUR ljepila s drugih materijala; međutim, zbog agresivnosti odstranjivača, odstranjivač treba prvo testirati.

### Pakiranje\*

Čistač ne stvrdnutog PUR ljepila

1 l

## ● Hraniclean 04



Otapa stvrdnuta ljepila na bazi poliuretana [PUR ljepila]. Proizvod koji je namijenjen čišćenju alata djeluje nekoliko minuta zahvaljujući otpornosti stvrdnutih poliuretanskih ljepila. Sredstvo za uklanjanje ne otapa ljepilo u potpunosti, ali ga može olabaviti s površine alata.

U iznimnim slučajevima može se koristiti za čišćenje drugih materijala, ali uvijek nakon obavljenih testova.

### Pakiranje\*

Čistač stvrdnutih ljepila PUR

1 l

## ● Hraniclean 05



Uklanja masnoće i smole. Prikladan je za oštrice pile, bušilice, glodalice, poklopce strojeva itd. Dulji rad može oštetiti neke obojene površine i aluminijske legure.

### Pakiranje

Čišćenje stolarskog alata

1 l; 5 l

\* Određena pakiranja nisu moguća u Vašoj zemlji. Za dostupnost pakiranja molimo Vas da se obratite Vašem prodajnom predstavniku.

## ● Hraniclean 07



Osušeni lakovi, boje i PVAc ljepljiva na bazi vode bubre i oslobađaju se. Čisti obojene jedinice, tiskarske forme, prostore za cirkulaciju, podove, alate itd. Ne koristiti kao koncentrat, nerazrijeđeni odstranjivač ne djeluje! Način razrjeđivanja s vodom: Za vrlo tvrdokorne premaze prikladan je omjer 1:5, za osušene slabije premaze omjer 1:14, a za neosušene premaze omjeri od 1:30 do 1:60. Nanesite sredstvo za uklanjanje na površinu koju čistite [uronite], ostavite nekoliko minuta, obrišite krpom i isperite vodom.

### Pakiranje\*

Koncentrirano sredstvo za čišćenje  
PVAc ljepljiva i boja

1 l; 5 l; 20 l

## ● Hraniclean 08



Ručno sredstvo za čišćenje dijelova namještaja visokog sjaja i osjetljivih ili tamnih površina. Ne ostavlja sloj na očišćenoj površini i brzo hlapi. Za čišćenje koristite čistu krpu ili papirnate ručnike. Testirati prije upotrebe.

### Pakiranje

Sredstvo za čišćenje  
osjetljivih površina

200 ml sprej; 600 ml sprej; 1 l; 5 l; 20 l

## ● Hraniclean SEP 11



Na tretiranim površinama, tekućina za odvajanje stvara tanki film koji sprječava lijepljenje PVAc ljepljiva. Prije upotrebe razrijediti vodom u omjeru 1:4, nanijeti na tretirane površine i pričekati da se osuši.

### Pakiranje\*

Sredstvo za odvajanje ljepljiva PVAc

1 l

## ● Hraniclean KLZ 21



Lubrikant je proizvod niske viskoznosti koji stvara dugotrajni film koji omogućuje glatko kretanje drva na stolu za blanjanje. Nanesite malu količinu maziva na stol za blanjanje i dobro ga rasporedite tekstilnom krpom. Lubrikant ima učinak čišćenja smola, vazelina i masti. Može oštetiti neke gumene brtve i gumene dijelove. Predmete onečišćene mazivom treba oprati vodom i normalnim deterdžentom. Ne sadrži hlapljive organske spojeve.

### Pakiranje\*

Sredstvo za klizanje za strojeve za blanjanje

1 l; 5 l

\* Određena pakiranja nisu moguća u Vašoj zemlji. Za dostupnost pakiranja molimo Vas da se obratite Vašem prodajnom predstavniku.



# Čistači za PUR

## ● Sredstvo za čišćenje PUR 890

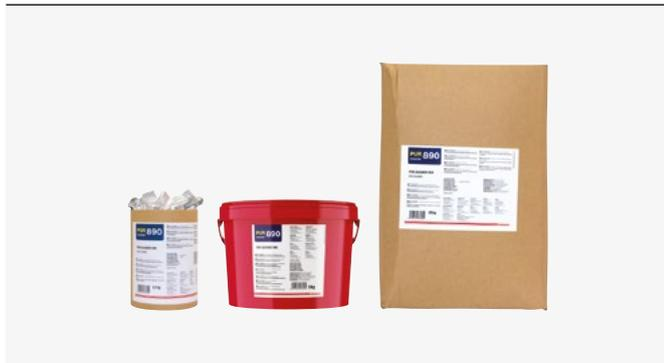

Pakiranje	Granulat 5 kg; 20 kg Uložak 1,7 kg
Baza	EVA
Preporučena upotreba	U posudi za taljenje
<b>Područje primjene</b>	
Redovito održavanje topljenja i uporaba uređaji za rad s vrućim ljepljivima na bazi EVA	...
Redovito održavanje topljenja i uporaba uređaji za rad s toplim ljepljivima na bazi PUR -a	...
Čišćenje alata, uređaja za topljenje i nanošenje onečišćenih stvrdnutim PUR toplim ljepljivom	x

... vrlo prikladno •• prikladno • tehnički moguće

## ● Sredstvo za čišćenje PUR 892 HL



Pakiranje	10 kg
Baza	Od poliestera i poliola
Preporučena upotreba	U posudi za taljenje
<b>Područje primjene</b>	
Redovito održavanje topljenja i uporaba uređaji za rad s vrućim ljepljivima na bazi EVA	...
Redovito održavanje topljenja i uporaba uređaji za rad s toplim ljepljivima na bazi PUR -a	...
Čišćenje alata, uređaja za topljenje i nanošenje onečišćenih stvrdnutim PUR toplim ljepljivom	...

# Pribor

## ● Hraniclean – Odvodna slavina



<b>Pakiranje</b>	
Za plastične kanistre od 20 i 30 litara	1 kom

## ● Hraniwipe – Krpa od mikro vlakana



<b>Pakiranje</b>	
Za završno čišćenje dijelova namještaja sredstvima za ručno čišćenje	1 kom

# Indeks

F00001	2.6	F000100	2.24	F000194	1.5	F000341	5.4	F000410	1.33	F000443	1.25	F000480	1.25	F000582	11.5
F000003	2.13	F000102	2.24	F000195	1.5	F000342	5.4	F000411	1.31	F000443	1.26	F000481	1.25	F000583	11.5
F000005	2.13	F000103	2.24	F000196	1.5	F000343	5.4	F000411	1.34	F000443	1.27	F000482	1.25	F000584	11.5
F000006	2.6	F000104	2.24	F000197	1.6	F000344	5.4	F000412	1.31	F000443	1.28	F000483	1.25	F000585	11.5
F000007	2.6	F000107	2.27	F000198	1.6	F000345	3.7	F000412	1.34	F000444	1.22	F000484	1.25	F000586	11.5
F000008	2.8	F000108	2.27	F000199	1.6	F000346	3.7	F000413	1.34	F000444	1.23	F000485	1.26	F000587	11.5
F000009	2.8	F000111	2.28	F000200	1.6	F000347	3.7	F000414	1.34	F000444	1.24	F000486	1.26	F000588	11.5
F000010	2.8	F000112	2.28	F000201	1.6	F000348	3.7	F000415	1.35	F000444	1.25	F000487	1.26	F000589	11.6
F000011	2.8	F000115	2.29	F000202	1.6	F000349	3.7	F000416	1.35	F000444	1.26	F000488	1.26	F000590	11.6
F000012	2.8	F000116	2.29	F000203	1.6	F000350	3.7	F000417	1.35	F000444	1.27	F000489	1.26	F000591	11.8
F000013	2.8	F000117	2.29	F000204	1.6	F000351	3.7	F000418	1.35	F000444	1.28	F000490	1.26	F000592	11.8
F000014	2.13	F000118	2.29	F000208	1.7	F000352	3.7	F000419	1.35	F000445	1.22	F000491	1.26	F000593	11.8
F000015	2.6	F000123	2.25	F000209	1.7	F000353	3.7	F000420	1.35	F000445	1.23	F000492	1.26	F000594	11.7
F000016	2.7	F000124	2.25	F000210	1.7	F000354	3.7	F000421	1.35	F000445	1.24	F000493	1.26	F000595	11.7
F000017	2.6	F000125	2.26	F000211	1.7	F000356	3.8	F000422	1.35	F000445	1.25	F000494	1.26	F000596	11.7
F000019	2.13	F000126	2.26	F000213	1.4	F000357	3.8	F000423	1.34	F000445	1.26	F000495	1.26	F000597	11.8
F000021	2.14	F000127	2.30	F000214	1.4	F000358	3.8	F000424	1.34	F000445	1.27	F000496	1.26	F000598	11.8
F000022	2.14	F000128	2.30	F000215	1.4	F000359	3.8	F000425	1.34	F000445	1.28	F000497	1.27	F000600	1.10
F000024	2.14	F000129	2.32	F000216	1.4	F000360	3.8	F000426	1.34	F000446	1.22	F000498	1.27	F000601	1.10
F000025	2.14	F000130	2.31	F000217	1.4	F000361	3.8	F000427	1.35	F000446	1.23	F000499	1.27	F000602	1.10
F000027	2.9	F000131	2.31	F000218	1.4	F000362	3.8	F000428	1.35	F000446	1.24	F000500	1.27	F000603	1.10
F000029	2.9	F000136	2.33	F000219	1.4	F000363	3.8	F000429	1.36	F000446	1.25	F000501	1.27	F000604	1.10
F000030	2.9	F000137	2.33	F000220	1.4	F000364	3.10	F000430	1.36	F000446	1.26	F000502	1.27	F000605	1.10
F000031	2.9	F000138	2.34	F000221	1.4	F000365	3.10	F000431	1.36	F000446	1.27	F000503	1.27	F000606	1.10
F000032	2.10	F000139	2.34	F000222	1.5	F000366	3.9	F000432	1.36	F000446	1.28	F000504	1.27	F000607	1.10
F000033	2.10	F000143	2.12	F000223	1.5	F000367	1.52	F000437	1.22	F000447	1.22	F000505	1.27	F000609	1.10
F000034	2.10	F000145	2.12	F000224	1.5	F000367	1.52	F000437	1.23	F000447	1.23	F000506	1.27	F000610	1.10
F000035	2.10	F000150	1.41	F000225	1.5	F000368	1.52	F000437	1.24	F000447	1.24	F000507	1.27	F000611	1.10
F000036	2.11	F000151	1.41	F000226	1.5	F000368	1.52	F000437	1.25	F000447	1.25	F000508	1.27	F000612	1.10
F000037	2.11	F000152	1.41	F000227	1.5	F000369	1.52	F000437	1.26	F000447	1.26	F000509	1.28	F000613	1.10
F000038	2.11	F000153	1.41	F000228	1.5	F000369	1.52	F000437	1.27	F000447	1.27	F000510	1.28	F000614	1.10
F000039	2.11	F000154	1.41	F000229	1.5	F000370	1.52	F000437	1.28	F000447	1.28	F000511	1.28	F000615	1.10
F000040	2.11	F000155	1.41	F000230	1.5	F000370	1.52	F000438	1.22	F000448	1.22	F000512	1.28	F000616	1.10
F000043	2.15	F000156	1.43	F000231	1.6	F000371	1.30	F000438	1.23	F000448	1.23	F000513	1.28	F000617	1.14
F000044	2.15	F000157	1.43	F000232	1.6	F000372	1.30	F000438	1.24	F000448	1.24	F000514	1.28	F000618	1.14
F000045	2.15	F000158	1.43	F000233	1.6	F000373	1.30	F000438	1.25	F000448	1.25	F000515	1.28	F000619	1.13
F000046	2.15	F000159	1.43	F000234	1.6	F000374	1.30	F000438	1.26	F000448	1.26	F000516	1.28	F000620	1.13
F000047	2.15	F000160	1.43	F000235	1.6	F000375	1.30	F000438	1.27	F000448	1.27	F000517	1.28	F000621	1.14
F000048	2.15	F000161	1.43	F000236	1.6	F000376	1.30	F000438	1.28	F000448	1.28	F000518	1.28	F000622	1.14
F000049	2.15	F000162	1.38	F000237	1.6	F000377	1.30	F000439	1.22	F000449	1.23	F000519	1.28	F000623	1.11
F000050	2.15	F000163	1.38	F000238	1.6	F000378	1.30	F000439	1.23	F000450	1.23	F000520	1.28	F000624	1.11
F000051	2.16	F000164	1.38	F000242	1.7	F000380	1.30	F000439	1.24	F000451	1.23	F000545	1.61	F000625	1.11
F000053	2.16	F000165	1.38	F000243	1.7	F000381	1.30	F000439	1.25	F000452	1.23	F000546	1.61	F000627	1.11
F000054	2.16	F000166	1.38	F000244	1.7	F000382	1.30	F000439	1.26	F000453	1.23	F000547	1.61	F000628	1.11
F000058	2.17	F000167	1.38	F000245	1.7	F000384	1.30	F000439	1.27	F000454	1.23	F000548	1.61	F000629	1.11
F000060	2.18	F000168	1.38	F000250	1.4	F000385	1.30	F000439	1.28	F000455	1.23	F000549	1.61	F000631	1.11
F000061	2.18	F000169	1.38	F000251	1.4	F000386	1.30	F000440	1.22	F000456	1.23	F000550	1.61	F000632	1.11
F000063	2.17	F000171	1.39	F000252	1.4	F000387	1.30	F000440	1.23	F000457	1.23	F000551	1.61	F000633	1.11
F000065	2.19	F000172	1.39	F000259	1.5	F000388	1.30	F000440	1.24	F000458	1.23	F000552	1.61	F000635	1.12
F000066	2.19	F000173	1.39	F000260	1.5	F000389	1.31	F000440	1.25	F000459	1.23	F000553	1.61	F000636	1.12
F000068	2.19	F000174	1.39	F000261	1.5	F000390	1.31	F000440	1.26	F000460	1.23	F000554	1.61	F000637	1.12
F000069	2.19	F000175	1.39	F000267	1.6	F000391	1.31	F000440	1.27	F000461	1.24	F000555	1.61	F000638	1.12
F000071	2.17	F000176	1.39	F000268	1.6	F000392	1.31	F000440	1.28	F000462	1.24	F000556	1.61	F000639	1.12
F000074	2.20	F000177	1.39	F000269	1.6	F000393	1.29	F000441	1.22	F000463	1.24	F000557	1.61	F000640	1.12
F000077	2.20	F000178	1.39	F000276	1.7	F000394	1.29	F000441	1.23	F000464	1.24	F000558	1.61	F000641	1.12
F000079	2.21	F000179	1.4	F000277	1.7	F000395	1.29	F000441	1.24	F000465	1.24	F000561	1.61	F000642	1.12
F000081	2.21	F000180	1.4	F000282	1.42	F000396	1.29	F000441	1.25	F000466	1.24	F000562	1.61	F000643	1.12
F000082	2.21	F000181	1.4	F000283	1.42	F000397	1.29	F000441	1.26	F000467	1.24	F000563	1.61	F000644	1.12
F000084	2.22	F000182	1.4	F000284	1.42	F000398	1.29	F000441	1.27	F000468	1.24	F000564	1.61	F000645	1.12
F000085	2.22	F000183	1.4	F000285	1.42	F000399	1.29	F000441	1.28	F000469	1.24	F000565	1.61	F000646	1.12
F000087	2.22	F000184	1.4	F000286	1.42	F000400	1.29	F000442	1.22	F000470	1.24	F000566	1.61	F000648	1.9
F000088	2.22	F000185	1.4	F000287	1.42	F000401	1.29	F000442	1.23	F000471	1.24	F000569	11.4	F000649	1.9
F000090	2.23	F000186	1.4	F000295	1.40	F000402	1.29	F000442	1.24	F000472	1.24	F000570	11.4	F000650	1.9
F000093	2.24	F000187	1.4	F000296	1.40	F000403	1.29	F000442	1.25	F000473	1.25	F000571	11.4	F000651	1.9
F000094	2.24	F000188	1.5	F000297	1.40	F000404	1.29	F000442	1.26	F000474	1.25	F000572	11.4	F000652	1.9
F000095	2.24	F000189	1.5	F000298	1.40	F000405	1.32	F000442	1.27	F000475	1.25	F000577	11.4	F000653	1.9
F000096	2.24	F000190	1.5	F000299	1.40	F000406	1.32	F000442	1.28	F000476	1.25	F000578	11.4	F000654	1.9
F000097	2.24	F000191	1.5	F000300	1.40	F000407	1.33	F000443	1.22	F000477	1.25	F000579	11.4	F000655	1.9
F000098	2.24	F000192	1.5	F000301	1.40	F000408	1.33	F000443	1.23	F000478	1.25	F000580	11.4	F000657	1.9
F000099	2.24	F000193	1.5	F000339	5.4	F000409	1.33	F000443	1.24	F000479	1.25	F000581	11.5	F000658	1.9

F000659	1.9	F000751	1.57	F000811	1.46	F000886	5.40	F000967	9.13	F001037	10.54	F001248	4.39	F001318	14.11
F000660	1.9	F000752	1.57	F000812	1.46	F000887	5.40	F000968	9.13	F001038	10.54	F001249	4.39	F001319	14.11
F000661	1.9	F000754	1.58	F000812	1.46	F000888	5.40	F000969	9.13	F001039	10.54	F001250	4.39	F001321	14.11
F000662	1.9	F000755	1.58	F000813	1.46	F000889	5.40	F000970	9.13	F001040	11.9	F001251	4.39	F001322	14.11
F000663	1.9	F000756	1.58	F000813	1.46	F000890	6.4	F000971	9.13	F001041	11.9	F001252	4.39	F001323	14.11
F000664	1.9	F000757	1.58	F000814	1.46	F000891	6.4	F000972	9.13	F001042	11.9	F001253	4.39	F001325	14.11
F000665	1.9	F000759	1.59	F000814	1.46	F000892	6.4	F000973	9.13	F001043	11.9	F001254	4.39	F001326	14.11
F000666	1.9	F000760	1.59	F000815	1.48	F000893	6.4	F000974	9.13	F001044	11.9	F001255	4.39	F001327	14.11
F000667	1.9	F000761	1.59	F000815	1.48	F000894	6.4	F000975	9.13	F001045	11.9	F001256	4.41	F001329	14.11
F000668	1.15	F000762	1.59	F000816	1.48	F000895	6.4	F000976	9.13	F001046	11.9	F001257	4.41	F001330	14.11
F000669	1.15	F000763	1.59	F000816	1.48	F000896	6.4	F000977	9.13	F001047	11.9	F001258	4.41	F001335	14.10
F000670	1.15	F000764	1.59	F000817	1.48	F000897	6.4	F000978	9.13	F001096	11.14	F001259	4.41	F001341	14.10
F000671	1.15	F000765	1.59	F000817	1.48	F000898	6.4	F000979	9.13	F001097	11.14	F001260	4.41	F001342	14.10
F000672	1.16	F000766	1.57	F000818	1.48	F000899	6.4	F000980	9.13	F001099	11.14	F001261	4.41	F001343	14.10
F000673	1.16	F000767	1.57	F000818	1.48	F000900	6.4	F000981	9.13	F001100	11.14	F001262	4.41	F001344	14.10
F000674	1.16	F000768	1.57	F000819	1.48	F000901	6.4	F000982	9.13	F001117	11.14	F001263	4.41	F001345	14.10
F000675	1.16	F000769	1.57	F000819	1.48	F000902	6.4	F000983	9.13	F001118	11.14	F001264	4.41	F001346	14.10
F000676	1.15	F000770	1.57	F000820	1.48	F000903	6.4	F000984	9.13	F001119	11.14	F001265	4.41	F001347	14.10
F000677	1.15	F000771	1.57	F000820	1.48	F000904	6.4	F000985	9.13	F001120	11.14	F001266	4.41	F001348	14.10
F000678	1.16	F000772	1.57	F000821	1.48	F000905	6.4	F000986	9.13	F001121	11.14	F001267	4.41	F001351	14.10
F000679	1.16	F000774	1.58	F000821	1.48	F000910	6.5	F000987	9.13	F001122	11.15	F001268	4.41	F001353	14.10
F000680	1.16	F000775	1.58	F000822	11.11	F000911	6.5	F000988	9.13	F001123	11.15	F001269	4.41	F001354	14.10
F000681	1.16	F000776	1.58	F000823	11.11	F000912	6.5	F000989	9.13	F001124	11.15	F001270	4.41	F001355	14.10
F000682	1.17	F000777	1.58	F000824	11.11	F000913	6.5	F000990	9.13	F001125	11.15	F001271	4.41	F001356	14.10
F000683	1.17	F000779	1.59	F000825	11.11	F000914	6.5	F000991	9.13	F001127	11.15	F001272	4.41	F001357	14.10
F000684	1.17	F000780	1.59	F000826	11.11	F000915	6.5	F000992	9.13	F001198	9.16	F001273	4.41	F001358	14.10
F000685	1.17	F000781	1.59	F000827	11.11	F000916	6.5	F000993	9.13	F001199	9.16	F001274	4.41	F001359	14.10
F000686	1.17	F000782	1.59	F000828	11.18	F000917	6.5	F000994	9.13	F001200	11.11	F001275	4.41	F001360	14.10
F000687	1.17	F000783	1.59	F000829	11.18	F000918	6.5	F000995	9.13	F001201	9.15	F001276	4.41	F001362	14.10
F000688	1.17	F000784	1.59	F000830	11.18	F000919	6.5	F000996	9.13	F001202	9.15	F001277	4.41	F001363	14.10
F000689	1.17	F000785	1.59	F000831	11.17	F000920	6.5	F000997	9.13	F001203	9.15	F001278	4.41	F001371	14.10
F000690	1.17	F000786	1.60	F000832	11.17	F000921	6.5	F000998	9.13	F001204	9.15	F001279	4.41	F001372	14.10
F000691	1.12	F000787	1.60	F000834	11.13	F000922	6.3	F000999	9.13	F001205	9.16	F001280	4.41	F001379	14.10
F000691	1.17	F000788	1.60	F000835	11.13	F000923	6.3	F001000	9.13	F001206	9.16	F001281	4.41	F001380	14.10
F000693	1.18	F000789	1.60	F000836	11.13	F000924	6.3	F001001	9.13	F001207	9.16	F001282	4.41	F001383	14.10
F000696	1.18	F000790	1.60	F000837	11.13	F000925	6.3	F001002	9.13	F001208	10.30	F001283	4.41	F001384	14.10
F000699	1.18	F000791	1.60	F000838	5.38	F000926	6.3	F001003	9.13	F001209	10.30	F001284	4.41	F001385	14.10
F000701	1.18	F000792	1.60	F000839	5.38	F000932	5.8	F001004	9.13	F001212	10.29	F001285	4.41	F001386	14.10
F000704	1.18	F000793	1.60	F000840	5.38	F000933	5.8	F001005	9.13	F001213	10.29	F001286	4.41	F001387	14.10
F000707	1.18	F000794	1.60	F000841	5.38	F000934	5.8	F001006	9.13	F001214	10.29	F001287	4.41	F001388	14.10
F000716	1.20	F000795	1.60	F000842	5.38	F000937	5.8	F001007	9.13	F001218	10.45	F001288	4.41	F001389	14.10
F000717	1.20	F000796	1.60	F000843	5.38	F000938	5.8	F001008	9.13	F001219	10.45	F001289	4.41	F001390	14.10
F000718	1.20	F000797	1.60	F000844	5.39	F000939	11.9	F001009	9.13	F001220	10.45	F001290	4.41	F001391	14.10
F000719	1.20	F000798	1.49	F000845	5.39	F000940	11.9	F001010	9.13	F001221	10.50	F001291	4.41	F001392	14.10
F000720	1.20	F000798	1.49	F000846	5.39	F000941	11.9	F001011	9.13	F001222	10.50	F001292	4.41	F001393	14.10
F000721	1.20	F000799	1.49	F000847	5.39	F000942	11.9	F001012	9.13	F001223	10.50	F001293	4.41	F001394	14.10
F000722	1.20	F000799	1.49	F000848	5.38	F000943	11.9	F001013	9.13	F001224	10.50	F001294	4.41	F001395	14.10
F000723	1.20	F000800	1.49	F000849	5.38	F000944	11.9	F001014	9.13	F001225	10.50	F001295	4.41	F001396	14.10
F000724	1.20	F000800	1.49	F000850	5.38	F000945	11.9	F001015	9.13	F001226	4.39	F001296	4.41	F001397	14.10
F000725	1.20	F000801	1.49	F000851	5.38	F000946	11.9	F001016	9.13	F001227	4.39	F001297	4.41	F001398	14.10
F000726	1.20	F000801	1.49	F000852	5.39	F000947	11.10	F001017	9.13	F001228	4.39	F001298	4.41	F001399	14.10
F000727	1.20	F000802	1.49	F000853	5.39	F000948	11.10	F001018	9.13	F001229	4.39	F001299	4.41	F001408	14.11
F000729	1.19	F000802	1.49	F000854	5.39	F000949	11.10	F001019	9.13	F001230	4.39	F001300	4.41	F001410	14.11
F000732	1.19	F000803	1.49	F000855	5.39	F000950	11.10	F001020	9.14	F001231	4.39	F001301	4.41	F001411	14.11
F000735	1.19	F000803	1.49	F000856	5.46	F000951	9.13	F001021	9.14	F001232	4.39	F001302	4.41	F001417	4.78
F000736	1.20	F000804	1.49	F000857	5.46	F000952	9.13	F001022	9.14	F001233	4.39	F001303	4.41	F001418	4.78
F000737	1.20	F000804	1.49	F000858	5.46	F000953	9.13	F001023	9.14	F001234	4.39	F001304	4.41	F001419	4.78
F000738	1.20	F000805	1.49	F000859	5.46	F000954	9.13	F001024	9.14	F001235	4.39	F001305	4.41	F001420	4.78
F000739	1.20	F000805	1.49	F000864	5.40	F000955	9.13	F001025	9.14	F001236	4.39	F001306	4.41	F001421	4.78
F000740	1.20	F000806	1.49	F000865	5.40	F000956	9.13	F001026	9.14	F001237	4.39	F001307	4.41	F001422	4.78
F000741	1.20	F000806	1.49	F000867	5.40	F000957	9.13	F001027	9.14	F001238	4.39	F001308	4.41	F001423	4.78
F000742	1.20	F000807	1.49	F000868	5.40	F000958	9.13	F001028	9.14	F001239	4.39	F001309	4.41	F001424	4.78
F000743	1.20	F000807	1.49	F000870	5.40	F000959	9.13	F001029	9.14	F001240	4.39	F001310	4.41	F001425	4.78
F000744	1.20	F000808	1.46	F000871	5.40	F000960	9.13	F001030	10.53	F001241	4.39	F001311	4.41	F001426	4.78
F000745	1.20	F000808	1.46	F000876	5.40	F000961	9.13	F001031	10.53	F001242	4.39	F001312	4.41	F001427	4.78
F000746	1.57	F000809	1.46	F000877	5.40	F000962	9.13	F001032	10.53	F001243	4.39	F001313	4.41	F001428	4.78
F000747	1.57	F000809	1.46	F000878	5.40	F000963	9.13	F001033	10.54	F001244	4.39	F001314	4.41	F001429	4.78
F000748	1.57	F000810	1.46	F000879	5.40	F000964	9.13	F001034	10.54	F001245	4.39	F001315	4.41	F001430	4.78
F000749	1.57	F000810	1.46	F000880	5.40	F000965	9.13	F001035	10.54	F001246	4.39	F001316	14.11	F001431	4.78
F000750	1.57	F000811	1.46	F000881	5.40	F000966	9.13	F001036	10.54	F001247	4.39	F001317	14.11	F001432	4.78

# Indeks

F001433	4.78	F001503	4.79	F001573	4.36	F001663	4.29	F001745	4.59	F001854	10.17	F001947	5.21	F002057	7.12
F001434	4.78	F001504	4.79	F001574	4.36	F001664	4.29	F001746	4.59	F001855	10.17	F001948	5.21	F002058	7.12
F001435	4.78	F001505	4.79	F001575	4.43	F001665	4.29	F001747	4.59	F001856	10.17	F001949	5.21	F002059	7.12
F001436	4.78	F001506	4.79	F001576	4.43	F001666	4.29	F001748	4.59	F001857	10.17	F001950	5.21	F002060	7.12
F001437	4.78	F001507	4.79	F001577	4.43	F001667	4.29	F001749	4.59	F001858	10.17	F001951	5.21	F002061	7.12
F001438	4.78	F001508	4.79	F001578	4.41	F001668	4.29	F001750	4.62	F001859	10.17	F001952	5.21	F002062	7.12
F001439	4.78	F001509	4.79	F001579	4.41	F001669	4.29	F001751	4.62	F001860	10.17	F001953	5.21	F002063	7.12
F001440	4.78	F001510	4.79	F001580	4.41	F001670	4.29	F001752	4.62	F001861	10.17	F001954	5.21	F002064	7.12
F001441	4.78	F001511	4.79	F001581	4.41	F001671	4.29	F001753	4.62	F001862	10.17	F001955	5.21	F002065	7.12
F001442	4.78	F001512	4.79	F001582	4.41	F001673	4.29	F001754	4.62	F001863	10.17	F001956	5.21	F002066	7.12
F001443	4.78	F001513	4.79	F001583	4.41	F001675	4.29	F001755	4.62	F001864	10.18	F001957	5.22	F002067	7.12
F001444	4.78	F001514	4.79	F001584	4.29	F001677	4.29	F001756	4.62	F001865	10.18	F001958	5.22	F002068	7.12
F001445	4.78	F001515	4.79	F001585	4.29	F001679	4.29	F001757	4.38	F001866	10.18	F001959	5.22	F002069	7.12
F001446	4.78	F001516	4.79	F001586	4.29	F001680	5.46	F001758	4.38	F001867	10.18	F001963	5.22	F002070	7.12
F001447	4.78	F001517	4.79	F001587	4.29	F001681	5.46	F001759	4.38	F001868	10.18	F001964	5.22	F002071	7.12
F001448	4.78	F001518	4.79	F001588	4.29	F001682	5.46	F001760	4.38	F001869	10.18	F001965	5.22	F002072	7.12
F001449	4.78	F001519	4.79	F001589	4.29	F001683	5.46	F001761	4.38	F001870	10.18	F001966	5.19	F002073	7.12
F001450	4.78	F001520	4.79	F001590	4.29	F001684	5.47	F001762	4.38	F001871	10.18	F001967	5.19	F002074	7.12
F001451	4.78	F001521	4.79	F001591	4.29	F001685	5.47	F001763	4.38	F001872	10.18	F001968	5.19	F002075	7.12
F001452	4.78	F001522	4.79	F001593	4.29	F001686	5.47	F001764	4.38	F001873	10.46	F001969	5.19	F002076	7.13
F001453	4.78	F001523	4.79	F001595	4.29	F001690	5.48	F001765	4.38	F001874	10.46	F001970	5.19	F002077	7.12
F001454	4.78	F001524	4.79	F001597	4.29	F001691	5.48	F001766	4.38	F001875	10.46	F001971	5.19	F002078	7.13
F001455	4.78	F001525	4.79	F001599	4.29	F001692	5.47	F001767	4.38	F001876	10.46	F001972	5.19	F002079	7.12
F001456	4.78	F001526	4.79	F001600	4.29	F001693	5.47	F001768	4.38	F001879	4.51	F001973	5.19	F002080	7.12
F001457	4.78	F001527	4.37	F001601	4.29	F001697	5.45	F001769	4.38	F001880	4.51	F001974	5.19	F002081	7.4
F001458	4.78	F001528	4.37	F001602	4.29	F001698	4.49	F001770	4.38	F001881	4.51	F001975	5.19	F002082	7.4
F001459	4.78	F001529	4.37	F001603	4.29	F001699	4.49	F001771	4.38	F001882	4.51	F001976	5.19	F002083	7.4
F001460	4.78	F001530	4.37	F001604	4.29	F001700	4.49	F001772	4.38	F001883	4.51	F001977	5.19	F002084	7.4
F001461	4.78	F001531	4.37	F001605	4.29	F001701	4.49	F001773	4.38	F001884	4.51	F001978	5.19	F002085	7.4
F001462	4.78	F001532	4.37	F001606	4.29	F001702	4.49	F001774	4.38	F001885	4.52	F001979	5.19	F002086	7.4
F001463	4.78	F001533	4.37	F001607	4.29	F001703	4.49	F001775	4.38	F001886	4.52	F001980	5.19	F002087	7.4
F001464	4.78	F001534	4.37	F001609	4.29	F001704	4.48	F001776	4.38	F001887	4.52	F001981	5.19	F002088	7.5
F001465	4.78	F001535	4.37	F001611	4.29	F001705	4.48	F001783	4.50	F001888	4.52	F001983	5.19	F002089	7.5
F001466	4.78	F001536	4.37	F001613	4.29	F001706	4.48	F001784	4.50	F001889	4.52	F001990	5.16	F002090	7.5
F001467	4.78	F001537	4.37	F001615	4.29	F001707	4.48	F001785	4.50	F001890	4.52	F002003	5.9	F002091	7.6
F001468	4.78	F001538	4.37	F001616	4.29	F001708	4.40	F001786	4.50	F001891	4.35	F002004	5.9	F002092	7.6
F001469	4.78	F001539	4.37	F001617	4.29	F001709	4.40	F001787	4.50	F001892	4.35	F002005	5.9	F002093	7.6
F001470	4.78	F001540	4.37	F001618	4.29	F001710	4.40	F001788	4.50	F001893	4.35	F002007	14.46	F002094	7.7
F001471	4.78	F001541	4.37	F001619	4.29	F001711	4.40	F001789	14.18	F001894	4.35	F002008	14.46	F002095	7.7
F001472	4.78	F001542	4.37	F001620	4.29	F001712	4.40	F001790	14.18	F001895	5.22	F002009	14.46	F002096	7.6
F001473	4.78	F001543	4.37	F001621	4.29	F001713	4.40	F001798	11.12	F001896	5.25	F002015	14.59	F002097	7.6
F001474	4.78	F001544	4.37	F001622	4.29	F001714	4.40	F001799	14.20	F001897	5.25	F002016	14.59	F002098	7.7
F001475	4.78	F001545	4.37	F001623	4.29	F001715	4.40	F001800	14.20	F001898	5.25	F002017	14.59	F002099	7.10
F001476	4.78	F001546	4.37	F001625	4.29	F001716	4.40	F001806	14.18	F001899	5.25	F002018	14.59	F002100	7.10
F001477	4.78	F001547	4.42	F001627	4.29	F001717	4.40	F001807	14.20	F001900	5.25	F002019	14.59	F002101	7.10
F001478	4.78	F001548	4.42	F001629	4.29	F001718	4.37	F001808	14.20	F001901	5.25	F002020	14.59	F002102	7.10
F001479	4.78	F001549	4.42	F001631	4.29	F001719	4.37	F001809	14.20	F001902	5.24	F002021	14.18	F002103	7.10
F001480	4.78	F001550	4.42	F001632	4.29	F001720	4.37	F001810	14.20	F001903	5.24	F002022	14.18	F002104	7.9
F001481	4.78	F001551	4.42	F001633	4.29	F001721	4.37	F001817	10.26	F001904	5.24	F002024	14.18	F002105	7.9
F001482	4.78	F001552	4.42	F001634	4.29	F001722	4.37	F001818	10.26	F001905	5.24	F002030	7.15	F002106	7.9
F001483	4.78	F001553	4.42	F001635	4.29	F001723	4.37	F001820	10.26	F001909	5.24	F002031	7.15	F002107	7.8
F001484	4.78	F001554	4.42	F001636	4.29	F001724	4.44	F001822	14.22	F001910	5.24	F002035	7.16	F002108	7.8
F001485	4.78	F001555	4.42	F001637	4.29	F001725	4.44	F001823	14.22	F001911	5.24	F002036	7.16	F002109	7.8
F001486	4.78	F001556	4.42	F001638	4.29	F001726	4.44	F001824	14.22	F001912	5.24	F002037	7.17	F002110	7.14
F001487	4.79	F001557	4.42	F001639	4.29	F001728	4.44	F001827	10.27	F001913	5.24	F002039	7.18	F002111	4.60
F001488	4.79	F001558	4.42	F001641	4.29	F001729	4.44	F001828	10.27	F001914	5.24	F002041	7.15	F002112	4.60
F001489	4.79	F001559	4.36	F001643	4.29	F001730	4.44	F001830	10.27	F001915	5.24	F002042	7.15	F002113	4.60
F001490	4.79	F001560	4.36	F001645	4.29	F001732	4.30	F001832	10.28	F001916	5.24	F002043	7.19	F002114	4.60
F001491	4.79	F001561	4.36	F001647	4.29	F001733	4.30	F001833	10.43	F001917	5.24	F002044	7.13	F002115	4.60
F001492	4.79	F001562	4.36	F001648	4.29	F001734	4.30	F001837	10.45	F001918	5.24	F002046	7.11	F002116	4.60
F001493	4.79	F001563	4.36	F001649	4.29	F001735	4.30	F001839	10.45	F001937	5.20	F002047	7.11	F002117	4.60
F001494	4.79	F001564	4.36	F001650	4.29	F001736	4.30	F001841	10.45	F001938	5.20	F002048	7.11	F002118	4.60
F001495	4.79	F001565	4.36	F001651	4.29	F001737	4.30	F001846	10.43	F001939	5.20	F002049	7.11	F002119	4.60
F001496	4.79	F001566	4.36	F001652	4.29	F001738	4.30	F001847	10.43	F001940	5.20	F002050	7.11	F002120	4.60
F001497	4.79	F001567	4.36	F001653	4.29	F001739	4.30	F001848	10.44	F001941	5.20	F002051	7.11	F002121	4.60
F001498	4.79	F001568	4.36	F001654	4.29	F001740	4.30	F001849	10.44	F001942	5.20	F002052	7.11	F002122	4.60
F001499	4.79	F001569	4.36	F001655	4.29	F001741	4.30	F001850	10.44	F001943	5.20	F002053	7.11	F002123	4.60
F001500	4.79	F001570	4.36	F001657	4.29	F001742	4.30	F001851	10.44	F001944	5.20	F002054	7.11	F002124	4.60
F001501	4.79	F001571	4.36	F001659	4.29	F001743	4.30	F001852	10.17	F001945	5.21	F002055	7.11	F002125	4.60
F001502	4.79	F001572	4.36	F001661	4.29	F001744	4.59	F001853	10.17	F001946	5.21	F002056	7.12	F002126	4.60

F002127	4.60	F002204	4.40	F002285	4.82	F002379	4.43	F002450	4.97	F002525	14.27	F002595	4.58	F002673	3.13
F002128	4.60	F002205	4.40	F002286	4.82	F002380	4.61	F002451	4.97	F002526	14.27	F002595	4.93	F002674	3.13
F002129	4.60	F002206	4.40	F002287	4.84	F002381	4.61	F002452	4.97	F002527	14.27	F002596	4.33	F002675	3.13
F002130	4.60	F002207	4.40	F002288	4.84	F002382	4.32	F002453	4.96	F002528	14.27	F002597	4.33	F002676	3.13
F002131	4.62	F002208	4.40	F002289	4.84	F002383	4.32	F002454	4.96	F002529	14.27	F002598	4.33	F002677	3.13
F002132	4.62	F002209	4.40	F002290	4.84	F002384	4.32	F002455	4.96	F002530	14.22	F002599	4.33	F002678	3.13
F002133	4.62	F002210	4.40	F002291	4.83	F002385	4.32	F002456	4.92	F002531	14.22	F002600	4.47	F002679	3.13
F002134	4.62	F002211	4.40	F002292	4.83	F002386	4.32	F002457	4.92	F002532	14.22	F002601	4.47	F002680	3.15
F002135	4.62	F002212	4.36	F002293	4.83	F002387	4.32	F002458	4.92	F002533	14.23	F002602	4.47	F002681	3.15
F002136	4.61	F002213	4.36	F002294	4.83	F002388	4.32	F002459	4.97	F002534	14.23	F002603	4.47	F002682	3.15
F002137	4.61	F002214	4.36	F002295	4.83	F002389	4.32	F002460	4.97	F002535	14.23	F002604	4.47	F002683	3.3
F002138	4.61	F002215	4.36	F002296	4.83	F002390	4.32	F002461	4.97	F002536	14.23	F002605	4.47	F002684	3.4
F002139	4.61	F002216	4.36	F002297	4.83	F002391	4.32	F002462	4.97	F002537	14.47	F002606	4.47	F002685	3.3
F002140	4.61	F002217	4.36	F002298	4.83	F002392	4.32	F002463	4.93	F002538	14.47	F002607	4.47	F002692	14.53
F002141	2.37	F002218	4.36	F002299	4.83	F002393	4.32	F002464	4.93	F002539	14.47	F002608	4.47	F002693	14.51
F002141	2.37	F002219	4.36	F002300	4.83	F002394	4.32	F002465	4.93	F002540	14.47	F002609	4.46	F002694	14.51
F002142	2.37	F002220	4.36	F002301	4.83	F002395	4.32	F002466	4.93	F002543	14.47	F002610	4.46	F002695	14.51
F002142	2.37	F002221	4.36	F002302	4.83	F002396	4.32	F002467	4.93	F002544	14.48	F002611	4.46	F002696	14.52
F002143	2.37	F002222	4.36	F002303	4.85	F002397	4.32	F002468	4.57	F002545	14.48	F002612	4.46	F002697	14.52
F002143	2.37	F002223	4.36	F002304	4.85	F002398	4.55	F002468	4.95	F002546	14.49	F002613	4.46	F002698	14.21
F002144	2.37	F002224	4.34	F002305	4.85	F002399	4.55	F002469	4.96	F002547	14.49	F002614	4.46	F002699	14.21
F002144	2.37	F002225	4.34	F002306	4.85	F002400	4.55	F002470	4.96	F002548	14.50	F002615	4.46	F002700	14.21
F002145	14.59	F002226	4.34	F002307	4.85	F002401	4.55	F002471	4.96	F002549	14.50	F002616	4.46	F002701	14.21
F002148	7.20	F002227	4.34	F002308	4.85	F002402	4.55	F002472	4.94	F002550	14.49	F002617	4.46	F002705	14.37
F002149	7.20	F002228	4.34	F002309	4.85	F002403	4.55	F002473	4.94	F002551	14.50	F002618	4.46	F002706	14.41
F002150	4.38	F002229	4.34	F002310	4.85	F002404	4.55	F002474	4.94	F002552	14.51	F002619	4.46	F002707	14.42
F002151	4.38	F002230	4.34	F002311	4.85	F002406	4.103	F002475	4.94	F002553	14.51	F002620	4.46	F002708	14.43
F002152	4.38	F002231	4.34	F002312	4.85	F002407	4.103	F002476	4.94	F002554	14.53	F002621	4.46	F002709	14.56
F002153	4.38	F002232	4.34	F002313	4.85	F002408	4.103	F002477	4.94	F002555	4.53	F002622	4.46	F002710	14.56
F002154	4.38	F002233	4.34	F002314	4.85	F002409	4.103	F002478	4.94	F002556	4.53	F002623	4.46	F002711	14.56
F002155	4.38	F002234	4.59	F002315	4.86	F002410	4.103	F002479	4.94	F002557	4.53	F002624	4.46	F002712	14.56
F002156	4.38	F002235	4.59	F002319	4.80	F002411	4.98	F002480	4.94	F002558	4.53	F002625	4.46	F002714	14.56
F002157	4.38	F002236	4.39	F002320	4.80	F002412	4.98	F002481	4.94	F002559	4.42	F002626	4.46	F002715	14.57
F002158	4.32	F002237	4.39	F002321	4.80	F002413	4.98	F002482	4.92	F002560	4.42	F002627	4.49	F002716	14.58
F002159	4.32	F002238	4.39	F002322	4.80	F002414	4.98	F002483	4.92	F002561	4.42	F002629	4.49	F002717	14.57
F002160	4.32	F002239	4.39	F002323	4.80	F002415	4.98	F002484	4.92	F002562	4.42	F002630	4.49	F002718	14.58
F002161	4.32	F002248	4.56	F002324	4.80	F002416	4.98	F002485	4.92	F002563	4.42	F002631	4.50	F002719	14.57
F002162	4.32	F002249	4.56	F002325	5.38	F002417	4.98	F002486	4.103	F002564	4.42	F002632	4.50	F002720	14.58
F002163	4.32	F002250	4.55	F002326	5.38	F002418	4.98	F002487	4.103	F002565	4.42	F002633	4.50	F002721	14.57
F002164	4.32	F002251	4.55	F002327	5.38	F002419	4.98	F002488	4.103	F002566	4.42	F002634	4.95	F002722	5.12
F002165	4.32	F002252	4.55	F002328	5.38	F002420	4.98	F002489	4.103	F002567	4.42	F002635	4.92	F002723	5.12
F002166	4.32	F002253	4.56	F002329	4.31	F002421	4.98	F002490	4.103	F002568	4.42	F002636	4.92	F002724	5.12
F002167	4.32	F002254	4.56	F002330	4.31	F002422	4.98	F002491	4.103	F002569	4.42	F002637	4.101	F002725	5.13
F002168	4.32	F002255	4.56	F002331	4.31	F002423	4.98	F002492	4.103	F002570	4.42	F002638	4.101	F002726	5.13
F002169	4.32	F002256	4.57	F002332	4.31	F002424	4.98	F002493	4.103	F002571	4.42	F002639	4.101	F002727	5.13
F002170	4.44	F002257	4.57	F002333	4.31	F002425	4.98	F002494	4.103	F002572	4.42	F002640	4.101	F002728	5.13
F002171	4.44	F002258	4.57	F002334	4.31	F002426	4.98	F002495	4.103	F002573	4.42	F002641	4.102	F002729	5.13
F002172	4.44	F002259	4.56	F002335	4.31	F002427	4.99	F002496	14.28	F002574	4.42	F002642	4.101	F002730	2.40
F002173	4.44	F002260	4.56	F002336	4.31	F002428	4.99	F002497	14.28	F002575	4.42	F002643	4.95	F002731	2.40
F002174	4.44	F002261	4.29	F002337	4.31	F002429	4.99	F002498	14.28	F002576	4.42	F002644	4.95	F002732	2.40
F002175	4.44	F002262	4.29	F002338	4.31	F002430	4.99	F002502	14.29	F002577	4.43	F002645	2.43	F002733	2.40
F002176	4.44	F002263	4.29	F002339	4.31	F002431	4.99	F002503	14.28	F002578	4.43	F002646	2.43	F002734	2.40
F002177	4.44	F002264	4.29	F002340	4.31	F002432	4.99	F002504	14.28	F002579	4.43	F002647	2.43	F002735	2.40
F002178	4.44	F002265	4.29	F002341	4.33	F002433	4.100	F002508	14.28	F002580	4.43	F002648	2.43	F002736	9.12
F002179	4.44	F002266	4.29	F002342	4.33	F002434	4.100	F002509	14.28	F002581	4.43	F002649	2.43	F002737	9.12
F002180	4.44	F002267	4.53	F002343	4.33	F002435	4.100	F002510	14.28	F002582	4.43	F002650	2.43	F002738	9.12
F002181	4.44	F002268	4.53	F002344	4.33	F002436	4.100	F002511	14.28	F002583	4.50	F002651	2.43	F002739	9.12
F002182	4.44	F002269	4.53	F002345	4.33	F002437	4.100	F002512	14.28	F002584	4.50	F002652	2.43	F002740	4.34
F002183	4.44	F002270	4.54	F002346	4.33	F002438	4.100	F002513	14.29	F002585	4.50	F002653	2.44	F002741	4.34
F002184	4.44	F002271	4.54	F002347	4.33	F002439	4.104	F002514	14.29	F002586	4.50	F002654	2.44	F002742	4.34
F002185	4.44	F002272	4.54	F002348	4.33	F002440	4.104	F002515	14.29	F002587	4.48	F002655	2.44	F002743	4.34
F002186	4.44	F002273	4.54	F002349	4.33	F002441	4.104	F002516	14.25	F002588	4.48	F002664	2.35	F002744	4.87
F002187	4.44	F002274	4.54	F002350	4.33	F002442	4.104	F002517	14.25	F002589	4.48	F002665	2.35	F002745	4.87
F002188	4.45	F002275	4.54	F002351	4.33	F002443	4.104	F002518	14.25	F002590	4.48	F002666	2.36	F002746	4.87
F002189	4.45	F002276	4.54	F002352	4.33	F002444	4.104	F002519	14.25	F002591	4.48	F002667	3.11	F002747	4.87
F002190	4.45	F002277	4.54	F002353	4.33	F002445	4.93	F002520	14.25	F002592	4.48	F002668	3.11	F002748	4.88
F002191	4.45	F002281	4.57	F002354	4.33	F002446	4.93	F002521	14.25	F002593	4.58	F002669	3.11	F002749	4.88
F002192	4.45	F002282	4.57	F002355	4.33	F002447	4.93	F002522	14.26	F002593	4.93	F002670	3.12	F002750	4.88
F002202	4.54	F002283	4.82	F002356	4.33	F002448	4.93	F002523	14.26	F002594	4.58	F002671	3.12	F002751	4.88
F002203	4.40	F002284	4.82	F002378	4.43	F002449	4.97	F002524	14.26	F002594	4.93	F002672	3.12	F002752	4.88

# Indeks

F002753	4.88	F002823	4.30	F002891	5.27	F002959	5.14	F003041	2.42	F003129	4.24	F003199	4.67	F003269	4.91
F002754	4.88	F002824	4.30	F002892	5.27	F002960	5.14	F003042	15.5	F003130	4.24	F003200	4.67	F003270	4.90
F002755	4.88	F002825	4.30	F002893	5.28	F002961	5.14	F003043	5.9	F003131	4.24	F003201	4.67	F003271	4.11
F002756	4.54	F002826	4.30	F002894	5.28	F002962	5.14	F003044	15.4	F003132	4.23	F003202	4.68	F003272	4.11
F002757	4.54	F002827	4.30	F002895	5.28	F002963	5.14	F003045	8.6	F003133	4.23	F003203	4.68	F003273	4.11
F002758	4.54	F002828	4.30	F002896	5.28	F002964	5.14	F003046	8.6	F003134	4.23	F003204	4.68	F003274	4.11
F002759	4.50	F002829	4.30	F002897	5.28	F002965	5.14	F003048	5.17	F003135	4.23	F003205	4.68	F003275	4.11
F002760	4.50	F002830	4.30	F002898	5.28	F002966	14.60	F003049	6.3	F003136	4.23	F003206	4.14	F003276	4.11
F002761	4.47	F002831	4.30	F002899	7.17	F002967	14.60	F003050	5.21	F003137	4.23	F003207	4.14	F003277	4.11
F002762	4.47	F002832	5.12	F002900	7.17	F002968	14.60	F003051	5.21	F003138	4.23	F003208	4.14	F003278	4.11
F002763	4.47	F002833	5.10	F002901	7.18	F002969	14.60	F003052	5.21	F003139	4.23	F003209	4.14	F003279	4.11
F002764	4.47	F002834	5.10	F002902	7.18	F002970	14.60	F003053	5.21	F003140	4.23	F003210	14.66	F003280	4.10
F002765	4.47	F002835	5.10	F002903	14.34	F002971	14.60	F003054	5.21	F003141	4.23	F003211	14.66	F003281	4.10
F002766	4.47	F002836	5.10	F002904	3.8	F002972	14.61	F003055	5.21	F003142	4.23	F003212	14.39	F003282	4.10
F002767	4.50	F002836	5.10	F002905	3.8	F002973	14.61	F003056	10.43	F003143	4.23	F003213	4.20	F003283	4.10
F002768	4.50	F002837	5.10	F002906	1.50	F002975	14.61	F003057	5.23	F003144	4.23	F003214	4.20	F003284	4.10
F002769	11.13	F002838	14.34	F002906	1.50	F002976	14.61	F003058	5.23	F003145	4.23	F003215	4.28	F003285	4.10
F002770	4.54	F002839	14.34	F002907	1.50	F002977	14.61	F003059	5.23	F003146	4.24	F003216	4.28	F003286	4.10
F002771	4.35	F002840	14.34	F002907	1.50	F002978	14.61	F003060	5.23	F003147	4.24	F003217	4.16	F003287	4.10
F002772	4.35	F002841	14.35	F002908	1.50	F002979	14.61	F003063	2.16	F003148	4.24	F003218	4.16	F003288	4.10
F002773	4.35	F002842	14.24	F002908	1.50	F002980	5.14	F003064	14.53	F003149	4.24	F003219	4.16	F003289	14.38
F002774	4.35	F002843	14.24	F002909	1.50	F002981	5.14	F003065	14.53	F003150	4.24	F003220	4.16	F003290	14.44
F002775	4.35	F002844	14.24	F002909	1.50	F002982	5.14	F003066	14.53	F003151	4.24	F003221	4.17	F003291	14.44
F002776	4.35	F002845	5.17	F002910	1.50	F002983	5.14	F003067	14.53	F003152	4.24	F003222	4.17	F003292	14.39
F002777	4.35	F002845	6.6	F002910	1.50	F002984	5.14	F003068	14.54	F003153	4.24	F003223	4.17	F003293	14.39
F002778	4.35	F002846	5.17	F002911	1.50	F002989	5.14	F003070	14.54	F003154	4.13	F003224	4.17	F003294	14.39
F002779	4.45	F002846	6.6	F002911	1.50	F002991	5.14	F003072	14.54	F003155	4.13	F003225	4.26	F003295	14.38
F002780	4.45	F002847	5.17	F002913	1.47	F002992	5.15	F003074	14.54	F003156	4.13	F003226	4.26	F003296	14.38
F002781	4.45	F002847	6.6	F002913	1.47	F002993	5.15	F003077	14.54	F003157	4.13	F003227	4.26	F003297	14.38
F002782	4.45	F002849	5.17	F002914	1.47	F002994	5.15	F003078	14.54	F003158	4.28	F003228	4.26	F003298	14.38
F002783	4.45	F002850	5.18	F002914	1.47	F002996	5.15	F003079	14.25	F003159	4.28	F003229	4.26	F003299	14.11
F002784	4.45	F002850	6.6	F002915	1.47	F002998	5.15	F003080	14.48	F003160	4.67	F003230	4.26	F003300	14.11
F002785	4.45	F002851	5.18	F002915	1.47	F002999	5.44	F003081	14.48	F003161	4.67	F003231	4.25	F003301	14.11
F002786	4.45	F002851	6.6	F002916	1.47	F003000	5.44	F003082	14.49	F003162	4.67	F003232	4.25	F003302	14.11
F002787	4.66	F002852	5.18	F002916	1.47	F003001	5.44	F003083	15.6	F003163	4.67	F003233	4.25	F003305	14.11
F002788	4.66	F002852	6.6	F002917	1.47	F003002	5.45	F003084	15.6	F003164	4.27	F003234	4.25	F003306	14.10
F002789	4.66	F002853	5.18	F002917	1.47	F003003	7.20	F003085	14.62	F003165	4.27	F003235	4.64	F003307	14.10
F002790	4.66	F002854	5.18	F002918	1.47	F003004	7.20	F003086	14.8	F003166	4.27	F003236	4.64	F003314	14.11
F002791	4.66	F002857	5.18	F002918	1.47	F003005	7.20	F003087	14.8	F003167	4.27	F003237	4.64	F003315	14.11
F002792	4.66	F002858	5.16	F002920	1.51	F003006	7.20	F003098	15.4	F003168	4.27	F003238	4.64	F003319	14.11
F002793	5.6	F002859	5.16	F002920	1.51	F003007	5.45	F003099	5.6	F003169	4.27	F003239	4.65	F003320	14.11
F002794	5.6	F002860	5.16	F002921	1.51	F003009	15.5	F003100	5.6	F003170	4.27	F003240	4.65	F003321	14.10
F002795	5.6	F002861	5.16	F002921	1.51	F003010	15.5	F003101	14.62	F003171	4.27	F003241	4.65	F003322	14.10
F002796	5.6	F002862	5.19	F002922	1.51	F003011	15.3	F003102	14.62	F003172	4.27	F003242	4.65	F003323	2.44
F002797	5.6	F002863	14.58	F002922	1.51	F003012	15.3	F003103	14.62	F003173	4.27	F003243	4.65	F003324	14.42
F002798	5.6	F002864	14.58	F002923	1.51	F003013	15.3	F003104	14.62	F003174	4.14	F003244	4.65	F003325	14.42
F002799	4.31	F002865	14.35	F002923	1.51	F003014	15.3	F003105	14.62	F003175	4.14	F003245	4.18	F003326	14.43
F002800	4.31	F002868	7.4	F002924	1.51	F003016	1.56	F003106	14.62	F003176	4.14	F003246	4.19	F003327	14.43
F002801	4.31	F002869	7.4	F002924	1.51	F003017	1.56	F003107	14.62	F003177	4.14	F003247	4.19	F003328	14.43
F002802	4.31	F002870	2.37	F002925	1.51	F003018	1.56	F003108	14.62	F003178	4.21	F003248	4.19	F003329	14.43
F002803	4.31	F002871	2.37	F002925	1.51	F003019	1.56	F003109	14.62	F003179	4.21	F003249	4.19	F003330	15.7
F002804	4.31	F002872	5.26	F002927	5.4	F003020	14.36	F003110	14.62	F003180	4.21	F003250	4.18	F003331	15.7
F002805	4.31	F002873	5.26	F002928	11.8	F003021	14.36	F003111	14.66	F003181	4.21	F003251	4.18	F003332	15.8
F002806	4.31	F002874	5.26	F002929	11.8	F003022	14.36	F003112	14.63	F003182	4.21	F003252	4.15	F003333	15.8
F002807	4.31	F002875	5.26	F002930	11.8	F003023	5.27	F003113	14.63	F003183	4.21	F003253	4.15	F003334	2.12
F002808	4.31	F002876	5.26	F002944	7.19	F003024	5.27	F003114	14.63	F003184	4.21	F003254	4.15	F003335	12.9
F002809	4.31	F002877	5.26	F002945	7.19	F003025	5.27	F003115	14.63	F003185	4.21	F003255	4.15	F003336	12.9
F002810	4.31	F002878	5.26	F002946	7.19	F003026	5.27	F003116	14.63	F003186	4.22	F003256	4.15	F003337	12.9
F002811	4.31	F002879	5.26	F002947	7.19	F003027	5.26	F003117	14.65	F003187	4.22	F003257	4.15	F003338	12.10
F002812	4.31	F002880	5.27	F002948	7.19	F003028	5.26	F003118	14.63	F003188	4.22	F003258	4.15	F003339	12.10
F002813	4.31	F002881	5.27	F002949	14.61	F003029	5.26	F003119	14.63	F003189	4.22	F003259	4.15	F003340	12.10
F002814	4.31	F002882	5.27	F002950	14.61	F003030	5.26	F003120	14.63	F003190	4.17	F003260	4.20	F003347	12.47
F002815	4.31	F002883	5.27	F002951	14.61	F003031	2.41	F003121	14.64	F003191	4.17	F003261	4.20	F003348	12.47
F002816	4.31	F002884	5.27	F002952	14.61	F003032	2.41	F003122	14.64	F003192	4.17	F003262	4.90	F003349	12.47
F002817	4.31	F002885	5.27	F002953	5.14	F003033	2.41	F003123	4.24	F003193	4.17	F003263	4.90	F003352	12.48
F002818	4.31	F002886	5.27	F002954	5.14	F003034	2.41	F003124	4.24	F003194	4.68	F003264	4.90	F003354	12.48
F002819	4.31	F002887	5.27	F002955	5.14	F003035	2.42	F003125	4.24	F003195	4.68	F003265	4.90	F003355	12.48
F002820	4.30	F002888	5.27	F002956	5.14	F003036	2.42	F003126	4.24	F003196	4.67	F003266	4.91	F003356	12.48
F002821	4.30	F002889	5.27	F002957	5.14	F003039	7.16	F003127	4.24	F003197	4.67	F003267	4.91	F003358	12.48
F002822	4.30	F002890	5.27	F002958	5.14	F003040	2.42	F003128	4.24	F003198	4.67	F003268	4.91	F003359	12.15

F003360	12.15	F003444	9.8	F003516	5.48	F003596	5.30	F004227	14.6	F004324	14.59	F004406	14.30	F004487	13.26
F003361	12.15	F003445	9.8	F003517	5.48	F003597	5.30	F004228	14.6	F004325	14.59	F004407	14.30	F004488	13.26
F003361	12.15	F003446	9.8	F003518	13.22	F003598	5.30	F004229	14.6	F004326	14.59	F004408	14.30	F004489	13.28
F003363	12.15	F003447	9.8	F003519	13.22	F003599	5.30	F004230	14.6	F004327	14.59	F004409	14.30	F004489	13.30
F003365	12.15	F003448	9.8	F003520	13.22	F003600	5.30	F004231	14.6	F004328	2.38	F004410	14.30	F004490	13.28
F003367	12.15	F003449	9.8	F003521	13.22	F003601	5.30	F004232	14.6	F004329	2.38	F004412	14.30	F004490	13.30
F003367	12.15	F003450	9.8	F003522	13.22	F003602	5.32	F004233	14.6	F004330	2.38	F004414	14.30	F004491	13.28
F003368	12.27	F003451	9.9	F003523	13.39	F003603	5.32	F004234	14.6	F004331	2.38	F004416	14.30	F004491	13.30
F003369	12.27	F003452	9.9	F003524	13.39	F003604	5.32	F004235	14.6	F004332	2.39	F004418	14.30	F004492	13.28
F003370	12.27	F003453	14.35	F003525	13.39	F003605	5.31	F004236	14.6	F004333	14.24	F004420	14.30	F004492	13.30
F003371	12.28	F003454	14.35	F003526	13.39	F003606	5.31	F004237	14.6	F004334	14.24	F004422	14.29	F004493	13.28
F003372	12.28	F003455	9.9	F003527	13.40	F003607	5.30	F004238	14.6	F004337	14.24	F004423	14.29	F004493	13.30
F003373	12.28	F003456	9.9	F003528	13.40	F003608	5.30	F004239	14.6	F004338	14.24	F004424	14.29	F004494	13.28
F003374	12.28	F003457	9.9	F003529	13.40	F003609	5.30	F004240	14.5	F004341	13.20	F004425	14.30	F004494	13.30
F003375	12.28	F003458	9.9	F003530	13.40	F003610	5.30	F004241	14.5	F004342	13.20	F004426	14.30	F004495	13.36
F003376	12.28	F003459	9.6	F003531	13.38	F003611	5.30	F004242	14.5	F004343	13.20	F004427	14.19	F004496	13.36
F003377	12.34	F003460	9.6	F003532	13.38	F003612	5.30	F004243	14.5	F004344	13.20	F004428	14.9	F004497	13.36
F003385	12.26	F003461	9.6	F003533	13.38	F003616	6.4	F004244	14.5	F004345	13.20	F004432	13.63	F004498	13.36
F003386	12.26	F003462	9.6	F003534	13.41	F003617	6.4	F004245	14.5	F004347	13.14	F004433	13.63	F004499	13.36
F003388	12.26	F003463	9.6	F003535	13.41	F003618	6.4	F004246	14.5	F004348	13.15	F004434	13.63	F004500	13.36
F003389	12.26	F003464	9.6	F003537	13.42	F003624	5.33	F004247	14.5	F004349	13.15	F004435	13.63	F004501	13.34
F003391	12.26	F003465	9.6	F003538	13.42	F003625	5.33	F004248	14.5	F004350	13.14	F004436	13.63	F004502	13.34
F003392	12.26	F003466	9.6	F003540	13.40	F003626	5.33	F004249	14.5	F004351	13.15	F004437	13.63	F004503	13.34
F003394	12.26	F003467	9.10	F003541	13.39	F003627	5.33	F004250	14.5	F004352	13.14	F004438	13.25	F004505	14.18
F003395	12.26	F003468	9.10	F003542	13.44	F003628	5.33	F004251	14.5	F004353	13.14	F004439	13.25	F004506	14.46
F003396	12.31	F003469	9.4	F003543	13.44	F003629	5.33	F004252	14.5	F004354	13.14	F004440	13.25	F004507	14.50
F003397	12.31	F003470	9.4	F003544	13.45	F003630	5.34	F004253	14.5	F004355	13.16	F004441	13.27	F004510	14.55
F003398	12.31	F003471	9.4	F003545	13.44	F003631	5.34	F004254	14.5	F004356	13.15	F004442	13.27	F004511	14.55
F003399	12.31	F003472	9.4	F003546	13.40	F003632	5.34	F004255	14.5	F004357	13.14	F004443	13.27	F004512	14.55
F003401	12.32	F003473	9.4	F003547	13.39	F003633	5.34	F004256	14.5	F004358	13.14	F004444	13.27	F004513	14.55
F003402	12.32	F003474	9.4	F003552	13.60	F003642	13.51	F004257	14.5	F004359	13.14	F004445	13.27	F004514	13.31
F003403	12.32	F003475	9.4	F003553	13.60	F003643	13.51	F004258	14.5	F004362	14.13	F004446	13.27	F004515	13.31
F003404	12.34	F003476	9.4	F003554	13.60	F003644	13.50	F004259	14.5	F004363	14.13	F004447	13.29	F004516	13.32
F003405	12.34	F003477	9.4	F003555	15.4	F003645	13.50	F004262	14.7	F004364	14.13	F004448	13.29	F004517	13.32
F003406	12.11	F003478	9.4	F003556	15.4	F003646	13.50	F004265	14.7	F004368	14.13	F004449	13.29	F004518	13.32
F003407	12.11	F003479	9.4	F003557	9.5	F003647	13.50	F004268	14.7	F004369	14.13	F004450	13.29	F004519	13.32
F003408	12.11	F003480	9.4	F003558	9.5	F003648	13.51	F004269	14.7	F004370	14.13	F004451	13.29	F004521	5.8
F003409	12.11	F003481	9.4	F003559	9.11	F003649	13.51	F004272	14.7	F004372	14.13	F004452	13.29	F004522	3.5
F003410	12.11	F003482	9.4	F003560	9.10	F003650	13.51	F004274	14.7	F004373	14.13	F004453	13.33	F004665	14.41
F003411	12.11	F003483	9.4	F003561	5.11	F003651	13.51	F004275	14.7	F004374	14.13	F004454	13.33	F004666	14.40
F003412	12.11	F003484	9.4	F003562	5.11	F003652	13.52	F004276	14.7	F004375	14.13	F004455	13.33	F004667	14.21
F003413	12.11	F003485	9.10	F003563	5.12	F003653	13.52	F004277	14.7	F004376	14.13	F004456	13.33	F004668	14.45
F003415	13.57	F003486	9.10	F003564	5.11	F003654	13.52	F004278	14.5	F004377	14.13	F004457	13.33	F004669	14.45
F003416	13.57	F003487	9.10	F003565	5.11	F003655	13.52	F004279	14.5	F004378	14.13	F004458	13.33	F004670	14.45
F003417	13.57	F003488	9.10	F003566	5.11	F003658	13.52	F004280	14.5	F004379	14.13	F004459	13.35	F004671	14.34
F003418	13.57	F003490	9.11	F003567	5.11	F003659	13.52	F004281	14.5	F004380	14.13	F004460	13.35	F004672	14.34
F003419	13.57	F003491	9.7	F003568	5.11	F003660	13.52	F004282	14.7	F004381	14.14	F004461	13.35	F004673	14.34
F003420	13.57	F003492	9.7	F003570	7.19	F003661	13.52	F004283	14.7	F004382	14.14	F004462	13.35	F004677	13.17
F003421	13.57	F003494	9.11	F003571	3.16	F003662	13.52	F004284	14.8	F004383	14.14	F004463	13.35	F004678	13.17
F003422	13.57	F003495	9.7	F003572	15.8	F003663	13.52	F004285	14.8	F004384	14.14	F004464	13.35	F004679	13.17
F003423	13.58	F003496	2.17	F003573	5.49	F004205	14.6	F004286	14.8	F004385	14.14	F004467	13.26	F004680	13.18
F003424	13.58	F003497	5.41	F003574	5.49	F004206	14.6	F004292	14.9	F004386	14.14	F004468	13.26	F004681	13.18
F003425	13.58	F003498	5.41	F003575	5.49	F004207	14.6	F004293	14.9	F004387	14.14	F004469	13.26	F004682	13.18
F003426	13.58	F003499	5.41	F003576	5.50	F004208	14.6	F004294	14.9	F004388	14.14	F004470	13.28	F004683	13.18
F003427	13.59	F003500	5.41	F003577	5.50	F004209	14.6	F004296	14.9	F004389	14.14	F004471	13.28	F004684	13.18
F003428	13.59	F003501	5.41	F003578	5.50	F004210	14.6	F004298	14.9	F004390	14.14	F004472	13.28	F004685	13.6
F003429	13.59	F003502	5.41	F003579	5.41	F004211	14.6	F004299	14.9	F004391	14.14	F004473	13.30	F004686	13.6
F003430	13.58	F003503	5.42	F003580	5.41	F004212	14.6	F004300	14.9	F004392	14.14	F004474	13.30	F004687	13.6
F003431	13.58	F003504	5.42	F003581	9.10	F004215	14.6	F004302	14.9	F004393	14.15	F004475	13.30	F004688	13.6
F003432	13.58	F003505	5.42	F003582	9.4	F004216	14.6	F004304	14.9	F004394	14.15	F004476	13.34	F004689	13.6
F003433	13.58	F003506	5.42	F003583	9.4	F004217	14.6	F004305	14.19	F004396	14.16	F004477	13.34	F004690	13.6
F003434	9.8	F003507	5.42	F003584	9.4	F004218	14.6	F004309	5.34	F004397	14.16	F004478	13.34	F004691	13.6
F003435	9.8	F003508	5.42	F003587	9.4	F004219	14.6	F004310	5.31	F004398	14.16	F004479	13.36	F004692	13.6
F003436	9.8	F003509	5.43	F003589	5.29	F004220	14.6	F004311	5.31	F004399	14.16	F004480	13.36	F004693	13.7
F003437	9.8	F003510	5.43	F003590	5.29	F004221	14.6	F004312	14.36	F004400	14.16	F004481	13.36	F004694	13.7
F003438	9.8	F003511	5.43	F003591	5.29	F004222	14.6	F004314	14.65	F004401	14.15	F004483	13.26	F004695	13.7
F003439	9.8	F003512	5.43	F003592	5.29	F004223	14.6	F004315	14.65	F004402	14.15	F004484	13.26	F004696	13.7
F003440	9.8	F003513	5.43	F003593	5.32	F004224	14.6	F004317	14.65	F004403	14.30	F004485	13.26	F004697	13.7
F003441	9.8	F003514	5.43	F003594	5.32	F004225	14.6	F004321	14.64	F004404	14.30	F004486	13.28	F004698	13.7
F003443	9.8	F003515	5.48	F003595	5.32	F004226	14.6	F004322	14.64	F004405	14.30	F004486	13.30	F004699	13.7

# Indeks

F004700	13.7	F004780	12.23	F004846	6.12	F004915	13.66	F004985	4.71	F005072	14.32	F005151	14.33	F005189	10.15
F004701	13.8	F004781	6.8	F004847	6.9	F004916	13.66	F004986	4.71	F005073	14.32	F005152	14.33	F005189	10.37
F004702	13.8	F004782	6.8	F004848	6.11	F004917	13.66	F004987	4.72	F005074	14.32	F005153	14.33	F005190	10.15
F004703	13.8	F004783	6.9	F004849	6.11	F004918	13.55	F004988	11.16	F005075	14.32	F005154	14.33	F005190	10.37
F004704	13.9	F004784	6.9	F004850	6.11	F004919	13.55	F004989	11.16	F005076	14.32	F005156	14.33	F005191	10.15
F004705	13.9	F004785	6.9	F004851	13.47	F004920	13.55	F004990	5.35	F005077	14.32	F005157	14.33	F005191	10.40
F004706	13.9	F004786	6.8	F004852	13.47	F004921	13.55	F004991	5.35	F005078	14.32	F005158	14.33	F005192	10.15
F004707	13.12	F004787	6.10	F004853	13.47	F004922	13.55	F004992	5.35	F005079	14.31	F005159	14.33	F005192	10.40
F004708	13.10	F004788	6.10	F004854	13.47	F004923	13.55	F004995	5.35	F005080	14.32	F005160	10.43	F005193	10.15
F004709	13.11	F004789	6.10	F004855	13.47	F004924	13.55	F004996	5.35	F005081	14.32	F005161	10.43	F005193	10.37
F004710	13.12	F004790	12.24	F004856	13.46	F004925	13.55	F004997	5.35	F005082	14.32	F005162	1.53	F005193	10.40
F004711	13.8	F004791	12.24	F004857	13.46	F004926	13.55	F004998	5.35	F005083	14.32	F005162	1.53	F005194	10.15
F004712	13.8	F004792	12.24	F004858	13.48	F004927	13.55	F005001	5.35	F005084	14.32	F005163	1.53	F005194	10.37
F004713	13.9	F004793	12.33	F004859	13.48	F004928	13.56	F005002	5.36	F005085	14.31	F005163	1.53	F005194	10.40
F004714	13.9	F004794	12.33	F004860	13.45	F004929	13.56	F005003	5.36	F005086	14.32	F005164	1.53	F005195	10.15
F004715	13.10	F004795	12.17	F004861	13.48	F004930	13.56	F005004	5.36	F005087	14.32	F005164	1.53	F005195	10.37
F004716	13.11	F004796	12.17	F004862	13.48	F004931	13.56	F005007	5.36	F005088	14.32	F005165	1.53	F005196	10.15
F004717	13.11	F004797	12.18	F004863	12.37	F004932	13.56	F005008	5.36	F005089	14.31	F005165	1.53	F005196	10.37
F004718	13.43	F004798	12.18	F004864	12.37	F004933	13.56	F005009	5.36	F005090	14.32	F005166	1.62	F005197	10.15
F004719	12.42	F004799	12.18	F004865	13.53	F004934	13.56	F005010	5.36	F005092	14.32	F005167	1.60	F005197	10.37
F004720	12.42	F004800	12.18	F004866	13.53	F004935	13.56	F005013	5.36	F005093	14.32	F005169	12.48	F005198	10.15
F004721	12.42	F004801	12.17	F004867	13.53	F004936	14.28	F005014	5.36	F005094	14.32	F005170	10.4	F005198	10.37
F004722	12.42	F004802	12.17	F004868	13.53	F004937	14.28	F005015	5.36	F005097	14.32	F005170	10.6	F005198	10.40
F004723	12.42	F004803	12.17	F004869	13.53	F004938	14.28	F005016	5.36	F005098	14.32	F005171	10.4	F005199	10.15
F004724	12.43	F004804	12.17	F004870	13.53	F004939	14.29	F005020	5.36	F005099	14.32	F005171	10.6	F005199	10.37
F004725	12.43	F004805	12.5	F004871	13.54	F004940	4.74	F005021	5.36	F005100	14.32	F005172	10.4	F005199	10.40
F004726	12.43	F004806	12.5	F004872	13.54	F004941	4.74	F005022	5.36	F005101	14.32	F005172	10.6	F005200	10.15
F004727	12.43	F004807	12.5	F004873	13.54	F004942	4.74	F005026	11.16	F005102	14.32	F005173	10.4	F005200	10.37
F004728	12.43	F004808	12.7	F004874	10.18	F004943	4.74	F005027	5.5	F005103	14.31	F005173	10.6	F005201	10.15
F004729	12.43	F004809	12.7	F004875	10.18	F004944	4.74	F005028	5.5	F005104	14.32	F005174	10.4	F005201	10.37
F004730	12.43	F004810	12.7	F004876	10.18	F004945	4.74	F005029	5.5	F005105	14.32	F005174	10.6	F005202	10.15
F004731	12.43	F004811	12.7	F004877	10.18	F004946	4.75	F005030	5.5	F005106	14.32	F005175	10.4	F005202	10.37
F004732	12.44	F004812	12.7	F004878	10.18	F004947	4.75	F005031	5.5	F005107	14.32	F005175	10.6	F005203	10.24
F004733	12.43	F004813	12.7	F004879	10.18	F004948	4.75	F005032	5.5	F005108	14.32	F005176	10.7	F005204	10.4
F004734	12.43	F004814	12.7	F004880	14.9	F004949	4.75	F005033	12.21	F005109	14.33	F005176	10.14	F005205	10.4
F004735	12.43	F004815	12.7	F004881	14.9	F004950	4.75	F005034	12.21	F005110	14.31	F005177	10.8	F005206	10.5
F004736	12.43	F004816	12.7	F004882	14.9	F004951	4.75	F005035	14.32	F005111	14.31	F005177	10.33	F005207	10.5
F004737	12.43	F004817	12.7	F004883	14.9	F004952	4.75	F005036	14.32	F005112	14.33	F005177	10.35	F005208	10.5
F004738	12.43	F004818	12.8	F004884	14.9	F004953	4.75	F005037	14.31	F005113	14.33	F005178	10.8	F005209	10.5
F004739	12.44	F004819	12.8	F004886	13.20	F004954	4.75	F005038	14.32	F005114	14.33	F005178	10.10	F005210	10.5
F004740	12.44	F004820	12.8	F004887	6.11	F004955	4.75	F005039	14.32	F005115	14.33	F005178	10.12	F005211	10.5
F004741	12.45	F004821	12.8	F004887	6.11	F004956	4.75	F005040	14.31	F005116	14.33	F005178	10.23	F005212	10.5
F004742	12.45	F004822	12.8	F004888	6.11	F004957	4.75	F005041	14.31	F005117	14.33	F005178	10.33	F005213	10.5
F004743	12.46	F004823	12.8	F004888	6.11	F004958	4.74	F005042	14.31	F005118	14.31	F005178	10.35	F005214	10.5
F004745	12.29	F004824	12.8	F004889	6.12	F004959	4.74	F005043	14.32	F005119	14.33	F005178	10.41	F005215	10.6
F004746	12.29	F004824	12.40	F004890	14.16	F004960	4.74	F005044	14.32	F005120	14.33	F005179	10.10	F005216	10.6
F004747	12.29	F004825	12.8	F004891	14.17	F004961	4.74	F005045	14.31	F005121	14.31	F005179	10.23	F005217	10.7
F004748	12.29	F004825	12.40	F004892	14.17	F004962	4.74	F005046	14.32	F005122	14.33	F005179	10.41	F005218	10.7
F004749	12.29	F004826	12.39	F004893	14.17	F004963	4.74	F005047	14.32	F005123	14.33	F005180	10.15	F005219	10.7
F004750	12.29	F004827	12.39	F004894	13.61	F004964	4.76	F005048	14.31	F005124	14.33	F005180	10.40	F005220	10.7
F004751	12.29	F004828	12.39	F004895	13.61	F004965	4.76	F005051	14.32	F005125	14.33	F005181	10.15	F005221	10.7
F004752	12.29	F004829	12.39	F004896	13.61	F004966	4.76	F005052	14.32	F005126	14.33	F005181	10.37	F005222	10.7
F004762	12.13	F004830	12.39	F004897	13.61	F004967	4.73	F005053	14.31	F005127	14.31	F005181	10.40	F005223	3.5
F004763	12.13	F004831	12.39	F004898	13.61	F004968	4.73	F005054	14.32	F005128	14.33	F005182	10.15	F005224	3.5
F004764	12.13	F004832	12.39	F004899	13.61	F004969	4.73	F005055	14.31	F005129	14.33	F005182	10.37	F005225	10.11
F004765	12.13	F004833	12.39	F004900	13.62	F004970	4.70	F005056	14.32	F005131	14.33	F005182	10.40	F005226	10.11
F004766	12.13	F004834	12.39	F004901	13.62	F004971	4.70	F005057	14.31	F005132	14.33	F005183	10.15	F005227	10.11
F004767	12.13	F004835	12.39	F004902	13.62	F004972	4.71	F005058	14.32	F005135	14.33	F005183	10.37	F005228	10.11
F004768	12.13	F004836	12.39	F004903	13.62	F004973	4.71	F005059	14.32	F005136	14.33	F005184	10.15	F005229	10.11
F004769	12.21	F004837	12.39	F004904	13.62	F004974	4.72	F005060	14.32	F005137	14.33	F005184	10.40	F005230	10.11
F004770	12.21	F004838	12.40	F004905	13.62	F004975	4.72	F005061	14.31	F005138	14.33	F005185	10.15	F005231	10.11
F004771	12.21	F004839	12.40	F004906	13.64	F004976	4.70	F005062	14.32	F005140	14.33	F005185	10.40	F005232	10.11
F004772	12.21	F004840	12.40	F004907	13.64	F004977	4.70	F005063	14.32	F005141	14.31	F005186	10.15	F005233	10.11
F004773	12.23	F004841	6.12	F004908	13.64	F004978	4.76	F005064	14.32	F005142	14.31	F005186	10.37	F005234	10.11
F004774	12.23	F004842	6.11	F004909	13.64	F004979	4.76	F005065	14.32	F005144	14.33	F005186	10.40	F005235	10.11
F004775	12.23	F004842	6.11	F004910	13.65	F004980	4.76	F005066	14.32	F005145	14.33	F005187	10.15	F005236	10.11
F004776	12.23	F004843	6.11	F004911	13.65	F004981	4.76	F005067	14.32	F005146	14.33	F005187	10.37	F005237	10.11
F004777	12.23	F004843	6.11	F004912	13.65	F004982	4.73	F005068	14.31	F005148	14.33	F005187	10.40	F005238	10.11
F004778	12.23	F004844	6.12	F004913	13.66	F004983	4.73	F005069	14.32	F005149	14.33	F005188	10.15	F005239	10.11
F004779	12.23	F004845	6.12	F004914	13.65	F004984	4.73	F005070	14.31	F005150	14.33	F005188	10.37	F005240	10.11



F005241	10.11	F005311	10.15	F005367	10.35	F005420	10.20	F005490	4.12	F007375	9.13
F005242	10.11	F005311	10.40	F005367	10.37	F005421	10.21	F005491	10.14	F007376	9.13
F005243	10.11	F005312	10.15	F005368	10.35	F005422	10.21	F005492	10.21	F007377	9.13
F005244	10.11	F005312	10.40	F005369	10.15	F005423	10.21	F005493	10.21	F007378	9.13
F005245	10.11	F005313	10.15	F005369	10.35	F005424	10.21	F005494	10.21	F007379	9.13
F005246	10.11	F005314	10.14	F005369	10.37	F005425	10.22	F005495	10.21	F007380	9.13
F005247	10.11	F005315	10.14	F005369	10.40	F005426	10.22	F005496	10.21	F007381	9.13
F005248	10.11	F005316	10.14	F005370	10.15	F005427	10.22	F005497	10.21	F007382	9.13
F005249	10.11	F005317	10.14	F005370	10.35	F005428	10.22	F005498	3.5	F007383	9.13
F005250	10.11	F005322	10.15	F005370	10.37	F005429	10.23	F005499	5.7	F007384	9.13
F005251	10.11	F005323	10.15	F005370	10.40	F005430	10.23	F005500	5.7	F007385	9.13
F005252	10.11	F005324	10.15	F005371	10.15	F005431	10.23	F005501	5.7	F007387	4.79
F005253	10.11	F005325	10.15	F005371	10.35	F005432	10.23	F005502	5.7	F007388	4.79
F005254	10.11	F005326	10.15	F005371	10.37	F005433	10.23	F005503	5.7	F007389	4.79
F005255	10.11	F005327	10.15	F005372	10.35	F005434	10.25	F005504	5.7	F007390	4.79
F005256	10.11	F005328	10.15	F005373	10.15	F005435	10.25	F005511	14.40	F007391	4.79
F005257	10.11	F005329	10.15	F005373	10.35	F005436	10.25	F005512	14.40	F007392	4.79
F005258	10.11	F005330	10.15	F005373	10.37	F005437	10.25	F005513	14.40	F007393	4.79
F005259	10.11	F005331	10.15	F005373	10.40	F005438	10.25	F005514	14.40	F007394	4.79
F005260	10.11	F005332	10.15	F005374	10.15	F005439	10.25	F005515	8.7	F007395	4.79
F005261	10.11	F005333	10.15	F005374	10.35	F005440	10.25	F005517	8.7	F007396	4.79
F005262	10.11	F005334	10.15	F005374	10.37	F005441	10.24	F005518	8.7	F007397	4.79
F005263	10.11	F005335	10.15	F005374	10.40	F005442	10.24	F005519	8.7	F007398	4.79
F005264	10.11	F005336	10.16	F005375	10.15	F005443	10.24	F005521	8.7	F007399	4.79
F005265	10.10	F005337	10.16	F005375	10.35	F005444	10.24	F005522	8.7	F007400	4.79
F005266	10.10	F005338	10.16	F005375	10.37	F005445	10.24	F005523	8.7	F007401	4.78
F005267	10.10	F005339	10.16	F005376	10.35	F005446	10.24	F005524	8.7	F007402	4.78
F005268	10.10	F005340	10.16	F005377	10.35	F005447	10.24	F005525	8.7	F007403	4.78
F005269	10.10	F005341	10.16	F005378	10.36	F005448	10.48	F005527	8.7	F007404	4.78
F005270	10.10	F005342	10.7	F005379	10.36	F005449	10.48	F005529	8.7	F007551	4.30
F005271	10.10	F005342	10.14	F005380	10.36	F005450	10.48	F005530	8.7	F007552	4.30
F005272	10.10	F005343	10.16	F005381	10.36	F005451	10.48	F005531	8.7	F007553	4.56
F005273	10.10	F005343	10.38	F005382	10.39	F005452	10.48	F005533	8.7	F007554	4.57
F005274	10.10	F005343	10.41	F005383	10.39	F005453	10.48	F005534	8.7	F007555	4.56
F005275	10.10	F005344	10.16	F005384	10.39	F005454	10.49	F005535	8.7	F007556	4.95
F005276	10.10	F005344	10.38	F005385	10.39	F005455	10.49	F005536	8.7		
F005277	10.10	F005344	10.41	F005386	10.41	F005456	10.49	F005537	8.7		
F005278	10.10	F005345	10.16	F005387	10.41	F005457	10.52	F005539	8.8		
F005279	10.10	F005345	10.38	F005388	10.42	F005458	10.25	F005541	8.8		
F005280	10.10	F005345	10.41	F005389	10.21	F005459	4.11	F005542	8.8		
F005281	10.10	F005346	10.16	F005390	10.21	F005460	4.11	F005543	8.8		
F005282	10.10	F005346	10.38	F005391	10.21	F005461	4.11	F005545	8.8		
F005283	10.10	F005346	10.41	F005392	10.21	F005462	4.13	F005546	8.8		
F005284	10.10	F005347	10.16	F005393	10.21	F005463	4.13	F005547	8.8		
F005285	10.10	F005348	10.32	F005394	10.21	F005464	4.13	F005548	8.8		
F005286	10.10	F005349	10.32	F005395	10.21	F005465	4.13	F005549	8.8		
F005287	10.10	F005350	10.32	F005396	10.21	F005466	4.13	F005554	13.34		
F005288	10.10	F005351	10.32	F005397	10.21	F005467	4.13	F005555	13.36		
F005289	10.10	F005352	10.32	F005398	10.21	F005468	4.13	F005556	8.4		
F005290	10.10	F005353	10.32	F005399	10.21	F005469	4.13	F005557	8.4		
F005291	10.10	F005354	10.33	F005400	10.21	F005470	4.12	F005558	8.4		
F005292	10.10	F005355	10.33	F005401	10.21	F005471	4.12	F005559	8.4		
F005293	10.12	F005356	10.33	F005402	10.21	F005472	4.12	F005560	8.5		
F005294	10.12	F005357	10.34	F005403	10.21	F005473	4.12	F005561	8.5		
F005295	10.12	F005358	10.34	F005404	10.21	F005474	4.12	F005562	8.6		
F005296	10.12	F005359	10.34	F005405	10.21	F005475	4.12	F005563	8.6		
F005297	10.12	F005360	10.34	F005406	10.21	F005476	4.12	F005574	12.13		
F005298	10.12	F005361	10.34	F005407	10.21	F005477	4.12	F005575	12.13		
F005299	10.12	F005362	10.34	F005408	10.21	F005478	4.12	F007363	9.13		
F005300	10.12	F005363	10.34	F005409	10.21	F005479	4.12	F007364	9.13		
F005301	10.13	F005364	10.34	F005410	10.21	F005480	4.12	F007365	9.13		
F005302	10.13	F005365	10.15	F005411	10.21	F005481	4.12	F007366	9.13		
F005303	10.13	F005365	10.35	F005412	10.21	F005482	4.12	F007367	9.13		
F005304	10.13	F005365	10.37	F005413	10.21	F005483	4.12	F007368	9.13		
F005305	10.13	F005365	10.40	F005414	10.21	F005484	4.12	F007369	9.13		
F005306	10.13	F005366	10.15	F005415	10.20	F005485	4.12	F007370	9.13		
F005307	10.13	F005366	10.35	F005416	10.20	F005486	4.12	F007371	9.13		
F005308	10.13	F005366	10.37	F005417	10.20	F005487	4.12	F007372	9.13		
F005309	10.13	F005366	10.40	F005418	10.20	F005488	4.12	F007373	9.13		
F005310	10.13	F005367	10.15	F005419	10.20	F005489	4.12	F007374	9.13		





## Kontakt

[www.hranipex.com](http://www.hranipex.com)  
[export@hranipex.com](mailto:export@hranipex.com)  
+420565501211

**HRANIPEX d.o.o.**  
Ulica Petra Hektorovića 2  
10000 Zagreb  
Republika Hrvatska